



Empowered lives.
Resilient nations.

Energy Conservation Building Code, 2017

User Manual



ENERGY EFFICIENCY IMPROVEMENTS
IN COMMERCIAL BUILDING

User Manual for the Energy Conservation Building Code, 2017

© Bureau of Energy Efficiency, 2017

Published by

Bureau of Energy Efficiency

4th Floor, Sewa Bhawan, R. K.Puram, New Delhi - 110066

Developed by

Energy Efficiency Improvements in Commercial Buildings

United Nations Development Programme

55, Lodhi Estate, Lodhi Road, New Delhi – 110 003

The contents of this publication may be freely reproduced for non-commercial purposes with attribution to the copyright holders.

First published in December 2017

Disclaimer

This document is produced as part of Component 2, Energy Efficiency improvements in Commercial Buildings (EECB). The views expressed in this publication, however, do not necessarily reflect those of the United Nations Development Programme and the Bureau of Energy Efficiency, Ministry of Power, Government of India.

MESSAGE



BUREAU OF ENERGY EFFICIENCY

(Ministry of Power, Government of India)

Abhay Bakre

Director General, Bureau of Energy Efficiency



Energy efficiency is crucial for realizing our commitments to environmental sustainability and quality of life. Energy Conservation Building Code (ECBC 2017) is a progressive standard for guiding building construction and will drive the building sector in India towards very high benchmarks in building energy efficiency. Experience with building codes globally shows that building energy efficiency is driven by a combination of legislation and also with consumer demand for high performance buildings. The fact that ECBC 2017 not only set the minimum efficiency standards for buildings, but also established higher thresholds of ECBC+ and SuperECBC to drive the market and consumers towards beyond code high performance buildings. The ECBC 2017 User Manual is a crucial tool for understanding and implementation of ECBC 2017 in order to ensure wider Code adoption.

The ECBC 2017 User Manual will help in understanding the design requirements and specifications of the Code for the users. ECBC 2017 is the most important policy for integrating energy efficient technologies and concepts in buildings at the time of design and construction in order to ensure an efficient building stock for the future. The Manual will also provide guidance to architects and engineers through examples and calculations for meeting the requirements of the Code.

On behalf of BEE, I acknowledge the invaluable role of the UNDP GEF Program, which has been a close partner for ECBC implementation efforts of BEE over the last 5 years. The team led by Dr. S N Srinivas and supported by Mr. Abdullah Nisar Siddiqui have directed the development of ECBC 2017 User Manual. The User Manual has been developed by Environmental Design Solutions [EDS] under contract with UNDP. I wish to acknowledge the effort of the EDS team in developing this comprehensive User Manual. Their efforts will ensure that the requirements of ECBC 2017 are easier to comprehend and implement.

I am confident that the ECBC 2017 User Manual will be a useful document for the building industry to support effective implementation of ECBC 2017.

Abhay Bakre

Director General
Bureau of Energy Efficiency

DEVELOPMENT TEAM

Bureau of Energy Efficiency

Abhay Bakre, Director General

Saurabh Diddi, Director

Arijit Sengupta, Director

United Nations Development Programme

S N Srinivas, Programme Analyst

Abdullah Nisar Siddiqui, Project Manger

Kanagaraj Ganesan, Consultant

Environmental Design Solutions

Tanmay Tathagat

Deepa Parekh

Mariyam Zakiah

Lakshmi G Kamath

Nitish Kanetkar

Abhishek Soni

Anamika Prasad

Gurneet Singh

Hisham Ahmad

Nabeel Ahmed

The goal of Energy Efficiency Improvements in Commercial Buildings (EECB) project is to reduce Green House Gas (GHG) emissions from the building sector in India through implementation of Energy Conservation Building Code (ECBC). EECB has 5 components, this document is one of the outputs under Component 2 which is on Technical Capacity Development.

ECBC 2017 User Manual

HOW TO USE THIS GUIDE

The purpose of this guide is to help the users understand the intent, requirement and potential application of the Code. It intends to demystify the Code. It is intended for users who might not be aware of all the technical requirements covered in the Code

Throughout the Code, there are examples and case studies given with the aim of reinforcing the concepts.

The User Guide follows the same structure (including the section numbers) as the Energy Conservation Building Code. It has been written in an easy to understand format using simple language supported by graphics.

Text shown in Blue is a direct excerpt from the ECBC document and is likely to serve as an anchor for the explanation given in different chapters.

TABLE OF CONTENTS

LIST OF TABLES	viii
LIST OF FIGURES	xii
1. Purpose	2
2. Scope.....	4
2.1 Energy Efficiency Performance Levels.....	4
2.2 Building Systems	5
2.3 Precedence.....	5
2.4 Reference Standards	5
2.5 Building Classification.....	5
3. Compliance and Approach.....	11
3.1 General.....	11
3.1.1 Energy Performance Index.....	11
3.1.2 Determining EPI Ratio.....	12
3.1.3 EPI Ratio for Core and Shell Buildings.....	12
3.1.4 EPI Ratio for Mixed-use Development.....	14
3.2 Compliance Approaches.....	17
3.2.1 Mandatory Requirements.....	17
3.2.2 Prescriptive Method	17
3.2.3 Whole Building Performance Method	18
3.3 Compliance Requirements	21
3.3.1 New Building Compliance	21
3.3.2 Additions and Alterations to Existing Buildings	21
3.4 Approved Analytical Tools.....	22
3.5 Administrative Requirements	22
3.6 Compliance Documents	22
3.6.1 Compliance Documents	22
3.6.2 Supplemental Information.....	23

4.	Building Envelope	26
4.1	General.....	26
4.2	Mandatory Requirements	35
4.2.1	Fenestration.....	35
4.2.2	Opaque construction	36
4.2.3	Daylighting	36
4.2.4	Building Envelope Sealing	51
4.3	Prescriptive Requirements.....	52
4.3.1	Roof.....	52
4.3.2	Opaque External Wall	56
4.3.3	Vertical Fenestration	57
4.3.4	Skylights	66
4.3.5	Building Envelope Trade-Off Method	67
4.3.6	Standard Building EPF Calculation	
5.	Comfort systems & controls	78
5.1	General.....	78
5.2	Mandatory Requirements	84
5.2.1	Ventilation	84
5.2.2	Minimum Space Conditioning Equipment Efficiencies	92
5.2.3	Controls.....	95
5.2.4	Piping and Ductwork.....	96
5.2.5	System Balancing	103
5.2.6	Condensers	105
5.2.7	Service Hot Water Heating	105
5.3	Prescriptive Requirements.....	110
5.3.1	Chillers	111
5.3.2	Pumps	111
5.3.3	Cooling Towers	112
5.3.4	Boilers	114
5.3.5	Economizers.....	114
5.3.6	Variable Flow Hydronic Systems.....	115

5.3.7	Unitary, Split and Packaged Air-Conditioners.....	116
5.3.8	Controls for ECBC+ and SuperECBC buildings.....	116
5.3.9	Controls for SuperECBC Buildings.....	117
5.3.10	Energy Recovery.....	117
5.3.11	Service Water Heating.....	118
5.3.12	Total System Efficiency – Alternate Compliance Approach.....	118
5.3.13	Low-energy Comfort Systems.....	119
6.	Lighting and Controls.....	124
6.1	General.....	124
6.2	Mandatory Requirements.....	125
6.2.1	Lighting Control.....	125
6.2.2	Exit Signs.....	130
6.3	Prescriptive Requirements.....	130
6.3.1	Interior Lighting Power.....	130
6.3.2	Building Area Method.....	130
6.3.3	Space Function Method.....	133
6.3.4	Installed Interior Lighting Power.....	137
6.3.5	Exterior Lighting Power.....	138
6.3.6	Controls for ECBC+ and SuperECBC Buildings.....	140
7.	Electrical and Renewable Energy Systems.....	144
7.1	General.....	144
7.2	Mandatory Requirements.....	154
7.2.1	Transformers.....	154
7.2.2	Energy Efficient Motors.....	159
7.2.3	Diesel Generator (DG)sets:.....	167
7.2.4	Check-Metering and monitoring.....	168
7.2.5	Power Factor Correction.....	170
7.2.6	Power Distribution Systems.....	171
7.2.7	Uninterruptible Power Supply (UPS).....	172
7.2.8	Renewable Energy Systems.....	172
8.	Definitions, Abbreviations, and Acronyms.....	177

8.1	General.....	177
8.2	Definitions.....	177
	A.....	177
	B.....	178
	C.....	179
	D.....	180
	E.....	183
	F.....	185
	G.....	186
	H.....	186
	I.....	187
	K.....	187
	L.....	187
	M.....	188
	N.....	189
	O.....	189
	P.....	190
	S.....	192
	T.....	194
	U.....	195
	V.....	195
	W.....	196
	Z.....	196
8.3	SI to IP Conversion Factors.....	197
8.4	Abbreviations and Acronyms.....	197
9.	Whole Building Performance Method.....	202
9.1	General.....	202
9.1.1	Scope.....	203
9.1.2	Compliance.....	204
9.1.3	Annual Energy Use.....	205
9.1.4	Trade-offs Limited to Building Permit.....	205

9.1.5	Documentation Requirements	205
9.2	Mandatory Requirements	206
9.3	Simulation Requirements.....	206
9.3.1	Energy Simulation Program	206
9.3.2	Climate Data	208
9.3.3	Compliance Calculations.....	209
9.4	Calculating Energy Consumption of Proposed Design and Standard Design 210	
9.4.1	Energy Simulation Model.....	210
9.4.2	HVAC Systems.....	210
9.4.3	Compliance Thresholds for ECBC compliant, ECBC+ and SuperECBC Buildings.....	227
9.5	Maximum Allowed EPI Ratios	227
9.6	Schedules	230
APPENDICES.....		254
10.	Appendix A: Default Values for Typical Constructions	255
10.1	Procedure for Determining Fenestration Product U-factor and Solar Heat Gain Coefficient	255
10.2	Default U-factors and Solar Heat Gain Coefficients for Unrated Fenestration Products	256
10.2.1	Unrated Vertical Fenestration.....	256
10.2.2	Unrated Sloped Glazing and Skylights	256
10.3	Typical Roof Constructions.....	256
10.4	Typical Wall Constructions.....	257
11.	Appendix B: Climate Zone Map of India	268
12.	Appendix C: Air-Side Economizer Acceptance Procedures.....	270
12.1	Construction Inspection	270
12.2	Equipment Testing	270
13.	Appendix D: Compliance Forms	271
14.	Appendix E: BEE approved list of software to show compliance	283
15.	REFERENCES	284

LIST OF TABLES

Table 4-1 Daylight Requirement	42
Table 4-2 Default Values for Surface Reflectance	43
Table 4-3 Daylight Extent Factors (DEF) for Manually Calculating Daylight Area	44
Table 4-4 Roof Assembly U-factor (W/m ² .K) Requirements for ECBC Compliant Building	52
Table 4-5 Roof Assembly U-factor (W/m ² .K) Requirements for ECBC+ Compliant Building	53
Table 4-6 Roof Assembly U-factor (W/m ² .K) Requirements for SuperECBC Building.....	53
Table 4-7 Opaque Assembly Maximum U-factor (W/m ² .K) Requirements for a ECBC compliant Building	56
Table 4-8 Opaque Assembly Maximum U-factor (W/m ² .K) Requirements for ECBC+ Compliant Building	56
Table 4-9 Opaque Assembly Maximum U-factor (W/m ² .K) Requirements for SuperECBC Building	56
Table 4-10 Vertical Fenestration Assembly U-factor and SHGC Requirements for ECBC Buildings	57
Table 4-11 Vertical Fenestration U-factor and SHGC Requirements for ECBC+ buildings and SuperECBC buildings	58
Table 4-12 Coefficients of Shading Equivalent Factors for Latitudes greater than or equal to 15 °N	59
Table 4-13 Coefficients of Shading Equivalent Factors for Latitudes less than 15 °N	59
Table 4-14 U-factor (W/m ² .K) Exemption Requirements for Shaded Building.....	66
Table 4-15 Skylight U-factor and SHGC Requirements (U-factor in W/m ² .K)	67
Table 4-16 Envelope Performance Factor Coefficients – Composite Climate	69
Table 4-17 Envelope Performance Factor Coefficients – Hot and Dry Climate	69
Table 4-18 Envelope Performance Factor Coefficients – Warm and Humid Climate	69
Table 4-19 Envelope Performance Factor Coefficients – Temperate Climate.....	70
Table 4-20 Envelope Performance Factor Coefficients – Cold Climate	70
Table 5-1 Minimum Energy Efficiency Requirements for water cooled Chillers	93
Table 5-2 Minimum Energy Efficiency Requirements for air cooled Chillers	93

Table 5-3 Minimum Requirements for Unitary, Split, Packaged Air Conditioners in ECBC Building	93
Table 5-4 Minimum Efficiency Requirements for VRF Air conditioners for ECBC Building*	94
Table 5-5 Minimum Efficiency Requirements for Computer Room Air Conditioners	94
Table 5-6 Minimum Efficiency Requirements for Oil and Gas Fired Boilers for ECBC building	95
Table 5-7 Insulation Requirements for Pipes in ECBC Building.....	98
Table 5-8 Insulation Requirements for Pipes in ECBC+ Building.....	98
Table 5-9 Insulation Requirements for Pipes in SuperECBC Buildings.....	99
Table 5-10 Ductwork Insulation (R value in m ² . K/W) Requirements.....	100
Table 5-11 Mechanical and Motor Efficiency Requirements for Fans in ECBC Buildings	111
Table 5-12 Mechanical and Motor Efficiency Requirements for Fans in ECBC+ Buildings	111
Table 5-13 Mechanical and Motor Efficiency Requirements for Fans in SuperECBC Buildings	111
Table 5-14 Minimum Energy Efficiency Requirements for water cooled Chillers	111
Table 5-15 Minimum Energy Efficiency Requirements for air cooled Chillers	111
Table 5-16 Pump Efficiency Requirements for ECBC Building	112
Table 5-17 Pump Efficiency Requirements for ECBC+ Building	112
Table 5-18 Pump Efficiency Requirements for SuperECBC Building	112
Table 5-19 Cooling Tower Efficiency Requirements for ECBC, ECBC+, and SuperECBC Buildings	113
Table 5-20 Minimum Efficiency Requirements for Oil and Gas Fired Boilers for ECBC+ and SuperECBC Buildings	114
Table 5-21 Minimum Requirements for Unitary, Split, Packaged Air Conditioners in ECBC+ Building.....	116
Table 5-22 Minimum Requirements for Unitary, Split, Packaged Air Conditioners in SuperECBC Building	116
Table 5-23 Minimum System Efficiency Requirement for ECBC, ECBC+, and SuperECBC Buildings	119
Table 6-1 Interior Lighting Power for ECBC Buildings – Building Area Method.....	132
Table 6-2 Interior Lighting Power for ECBC+ Buildings – Building Area Method.....	132

Table 6-3 Interior Lighting Power for SuperECBC Buildings – Building Area Method ..	133
Table 6-4 Interior Lighting Power for ECBC Buildings – Space Function Method	134
Table 6-5 Interior Lighting Power for ECBC+ Buildings – Space Function Method	135
Table 6-6 Interior Lighting Power for SuperECBC Buildings – Space Function Method	136
Table 6-7 Exterior Building Lighting Power for ECBC Buildings	139
Table 6-8 Exterior Building Lighting Power for ECBC+ Buildings	139
Table 6-9 Exterior Building Lighting Power for SuperECBC Buildings	139
Table 7-1 Dry Type Transformers	157
Table 7-2 Permissible Losses for Oil Type Transformers. Total losses for oil type transformers shall confirm with Indian Standard IS 1180.	158
Table 7-3 Sub Metering Requirements	170
Table 7-4 Energy Efficiency Requirements for UPS for ECBC, ECBC+, SuperECBC building	172
Table 7-5 Minimum Solar Zone Area/Renewable Energy Generating Zone Requirement for ECBC+ Building	174
Table 7-6 Minimum Solar Zone Area/Renewable Energy Generating Zone Requirement for SuperECBC Building	174
Table 9-1 Modelling Requirements for Calculating Proposed and Standard Design	211
Table 9-2 HVAC Systems Map for Standard Design	216
Table 9-3 Modeling Requirements for Calculating Proposed and Standard Design	225
Table 9-4 Power Adjustment Factors for Automatic Lighting Controls	226
Table 9-5 Maximum Allowed EPI Ratios for Building in Composite Climate	227
Table 9-6 Maximum Allowed EPI Ratios for Buildings in Hot and Dry Climate	227
Table 9-7 Maximum Allowed EPI Ratios for Buildings in Temperate Climate	228
Table 9-8 Maximum Allowed EPI Ratios for Buildings in Warm and Humid Climate ...	229
Table 9-9 Maximum Allowed EPI Ratios for Buildings in Cold Climate	229
Table 9-10 Schedules for Assembly Buildings	231
Table 9-11 Schedules for Business - Office Buildings	232
Table 9-12 Schedules for Educational - School Buildings (A)	233
Table 9-13 Schedules for Educational - University Buildings (A)	235
Table 9-14 Schedules for Healthcare - Hospital Buildings (A)	237
Table 9-15 Schedules for Healthcare – Out-patient Healthcare Buildings (A)	240

Table 9-16 Schedules for Hospitality Buildings (A)	242
Table 9-17 Schedules for Shopping Complexes Buildings (A)	247
Table 9-18 Schedules for Shopping Complex- Strip Retail & Supermall Buildings (A) ..	250
Table 9-19 Schedules for Shopping Complex- Strip Retail & Supermall Buildings (A) ..	251
Table 9-20 Schedules for Assembly Buildings.....	252
Table 9-21 Schedules for Business - Office Buildings.....	253
Table 10-1 Defaults for Unrated Vertical Fenestration (Overall Assembly including the Sash and Frame)	256
Table 10-2 Typical Thermal Properties of Common Building and Insulating Materials	258
Table 11-1 Climate Zone for Major Indian Cities	269
<i>Table 14-1 Bureau of Energy Efficiency Approved Software for Demonstrating Compliance with ECBC</i>	<i>283</i>

DRAFT

LIST OF FIGURES

Figure 2.1 Energy efficiency performance levels	4
Figure 4.1 Building Envelope	26
Figure 4.2 Heat transfer through building	26
Figure 4.3 Heat transfer through conduction	27
Figure 4.4 Heat transfer through convection	27
Figure 4.5 Convection in horizontal spaces	27
Figure 4.6 Convection through ventilation	28
Figure 4.7 Stratification in atrium space	28
Figure 4.8 Infiltration	28
Figure 4.9 Solar radiation spectrum	29
Figure 4.10 Radiation heat transfer through roof	29
Figure 4.11 Glass and radiation	29
Figure 4.12 Conductance and U-value	30
Figure 4.13 ECBC scope of compliance	31
Figure 4.14 Material interaction with radiation	33
Figure 4.15 Analogy of thermal loads and structural loads	34
Figure 4.16 Internal and external loads	34
Figure 4.17 Contrast	40
Figure 4.18 Direct glare	40
Figure 4.19 Indirect glare	40
Figure 4.20 Modeling surrounding obstructions	43
Figure 4.21 Projection Factor calculation	44
Figure 4.22 Daylit area calculation for vertical fenestration (section)	45
Figure 4.23 Daylight area calculation for vertical fenestration (plan)	45
Figure 4.24 Daylit area calculation for skylight	45
Figure 4.25 Daylit area calculation for sawtooth	46
Figure 4.26 Daylit area calculation for monitor	46

Figure 4.27 Roof insulation techniques	54
Figure 4.28 Detailed section of a vegetated roof	56
Figure 4.29 Window Wall Ratio	57
Figure 4.30 Using sunpath for showing compliance for surrounding obstruction	62
Figure 4.31 Daylight and vision window	62
Figure 4.32 PF for interior light shelf	63
Figure 4.33 PF for south interior light shelf	63
Figure 4.34 PF for north interior light shelf	63
Figure 4.35 Skylight Roof Ratio (SRR)	66
Figure 5.1 Air conditioning analogy	79
Figure 5.2 Refrigeration cycle	80
Figure 5.3 Vapor absorption cycle	81
Figure 5.4 Window air conditioner	82
Figure 5.5 Split air conditioner	82
Figure 5.6 Packaged unit located on roof top	82
Figure 5.7 Different configurations for a central plant	83
Figure 5.8 Chilled water pipe insulation installation	97
Figure 5.9 Ductwork in a mechanical room	99
Figure 5.10 Insulated ducts	99
Figure 5.11 Air distribution scheme	103
Figure 5.12 Flat plate collector	106
Figure 5.13 Evacuated tube collector	106
Figure 5.14 Cross section of an evacuated tube	106
Figure 5.15 Heat trap elements	110
Figure 5.16 Economizer	114
Figure 5.17 Chiller plant schematic	118
Figure 7.1 Function of electrical system	144
Figure 7.2 Analogy between electrical and hydraulic system	144
Figure 7.3 Direct and alternating current	145
Figure 7.4 DC generator operation	146
Figure 7.5 Alternator operation	146

Figure 7.6 DC and AC representation	146
Figure 7.7 Simple representation of electric circuit	148
Figure 7.8 Phase difference due to reactive power	149
Figure 7.9 Reactive power by inductive load	149
Figure 7.10 Power Factor	149
Figure 7.11 Series circuit arrangement.....	151
Figure 7.12 Parallel circuit arrangement	152
Figure 7.13 Sample electrical layout for a classroom	153
Figure 7.14 Electrical system of a commercial building.....	153
Figure 7.15 Sub-station transformer	154
Figure 7.16 Pole-mounted distribution transformer	154
Figure 7.17 Transformer working principle	155
Figure 7.18 Transformer losses	157
Figure 7.19 Feeder and distributors	159
Figure 7.20 Electric motor	159
Figure 7.21 Motor classification	160
Figure 7.22 Parts of an induction motor.....	160
Figure 7.23 Submetering	169
Figure 7.24 Power factor correction.....	171

1 Purpose



1. PURPOSE

The purpose of the Energy Conservation Building Code (Code) is to provide minimum requirements for the energy-efficient design and construction of buildings. The Code provides two additional sets of incremental requirements for buildings to achieve enhanced levels of energy efficiency that go beyond the minimum requirements.

The building sector represents about 33% of electricity consumption in India, with commercial sector and residential sector accounting for 8% and 25% respectively. Estimates based on computer simulation models indicate that ECBC-compliant buildings can use 40% to 60% less energy than conventional buildings. It is estimated that the nationwide mandatory enforcement of the ECBC will yield annual savings of approximately 1.7 billion kWh. The ECBC is expected to overcome market barriers, which otherwise result in under-investment in building energy efficiency.

The ECBC was developed as a first step towards promoting energy efficiency in the building sector. The ECBC (also referred to as “The Code” in this document) is the result of extensive work by the Bureau of Energy Efficiency (BEE) and its Committee of Experts. It is written in code-enforceable language and addresses the views of the manufacturing, design, and construction communities as an appropriate set of minimum requirements for energy-efficient building design and construction.

For developing the Code, building construction methods across the country were reviewed and various energy efficient design and construction practices were evaluated that could reduce energy consumption in building. In addition,

detailed life-cycle cost analyses were conducted to ensure that the Code requirements reflect cost effectiveness and practical efficiency measures across five different climate zones in India. While taking into account different climate zones, the Code also addresses site orientation and specifies better design practices and technologies that can reduce energy consumption without sacrificing comfort and productivity of the occupants.

The ECBC User Guide (also referred to as “The Guide” in this document) has been developed to provide detailed guidance to building owners, designers, engineers, builders, energy consultants, and others on how to comply with the Code. It provides expanded interpretation, examples, and supplementary information to assist in applying ECBC during the design and construction of new buildings as well as additions and alterations to existing buildings. This Guide can also be used as a document by “authorities having jurisdiction” in the enforcement of the Code once it is made mandatory. The Guide follows the nomenclature of the Code. It is written both as a reference and as an instructional guide, that can be helpful for anyone who is directly or indirectly involved in the design and construction of ECBC-compliant buildings.

2 Scope



2. SCOPE

The Code is applicable to buildings or building complexes that have a connected load of 100 kW or greater or a contract demand of 120 kVA or greater and are intended to be used for commercial purposes.

Buildings intended for private residential purposes only are not covered by the Code.

Generally, buildings or complexes having conditioned area of 500 m² or more will fall under this category.

The Code is presently under voluntary adoption in the country.

This Code would become mandatory as and when it is notified by the Central and State government in the official Gazette under clause (p) of §14 or clause (a) of §15 of the Energy Conservation Act 2001 (52 of 2001).

2.1 Energy Efficiency Performance Levels

In addition to Code compliance, ECBC has introduced two voluntary performance thresholds for buildings that choose to go beyond Code and achieve higher energy performance (Figure 2.1).

The materials and technology to design a high performance building is available in the market today. The first cost might be higher, but the life cycle cost is lower. In the near future, market transformation will make high performance buildings mainstream. This will further help in the smooth transition to the next technical update of the Code with higher stringency levels eventually leading the country towards the net-zero energy goal.

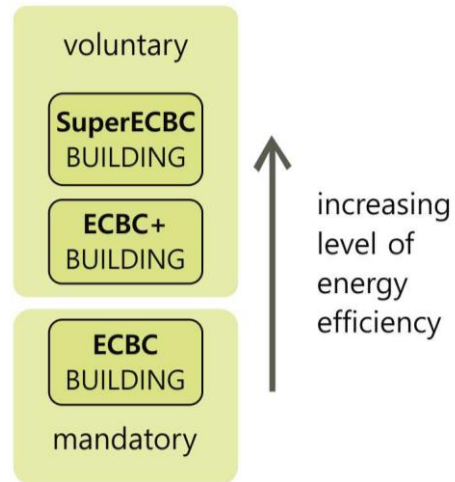

Figure 2.1 Energy efficiency performance levels

The code prescribes the following three levels of energy efficiency:

- (a) Energy Conservation Building Code Compliant Building (ECBC Building)

The Code compliant building will incorporate all the minimum requirements as enumerated in the Code. Buildings that are in the purview of the Code will have to be an ECBC building at the minimum.

ECBC Buildings shall demonstrate compliance by adopting the mandatory and prescriptive requirements listed under ECBC Compliant Building requirements in §4 to §7, or by following the provisions of the Whole Building Performance (WBP) Method in §0.

- (b) Energy Conservation Building Code Plus Building (ECBC+ Building)

This is the first threshold of performance beyond Code compliance.

ECBC+ Buildings shall demonstrate compliance by adopting the mandatory and prescriptive requirements listed under ECBC+ Compliant Building requirements §4 to §7, or by following the provisions of the

Whole Building Performance (WBP) Method in §0.

- (c) Super Energy Conservation Building Code Building (SuperECBC Building)

This is the second and highest threshold of performance beyond Code compliance. High performance buildings can aim to meet the SuperECBC requirements.

SuperECBC Buildings shall demonstrate compliance by adopting the mandatory and prescriptive requirements listed under SuperECBC Compliant Building requirements in §4 to §7, or by following the provisions of the Whole Building Performance (WBP) Method in §0.

2.2 Building Systems

The provisions of this code apply to:

- (a) Building envelope,
- (b) Mechanical systems and equipment, including heating, ventilating, and air conditioning, service hot water heating,
- (c) Interior and exterior lighting, and
- (d) Electrical power and motors, and renewable energy systems.

The provisions of this code do not apply to plug loads, and equipment and parts of buildings that use energy for manufacturing processes, unless otherwise specified in the Code.

2.3 Precedence

The following codes, programs, and policies will take precedence over the Code in case of conflict:

- (a) Any policy notified as taking precedence over this Code, or any other rules on safety,

security, health, or environment by Central, State, or Local Government.

- (b) Bureau of Energy Efficiency's Standards and Labelling for appliances and Star Rating Program for buildings, provided both or either are more stringent than the requirements of this Code.

Largely, technology update takes place faster than technical updates in the Code. It is important for a Code to stay current to achieve its larger goals of energy efficiency over time. Thus, to keep the Code dynamic, the above-mentioned codes, programs and policies have been included so that the latest in the technological requirements will take precedence as when it is introduced.

2.4 Reference Standards

The National Building Code of India 2016 (NBC) is the reference standard for lighting levels, heating, ventilating, and air conditioning (HVAC), thermal comfort conditions, natural ventilation, and any other building materials and system design criteria addressed in this Code.

2.5 Building Classification

There are many different types of commercial buildings that fall under the purview of the Code. These buildings are different from each other in basic typology, usage of spaces and occupancy. For example, a school is fundamentally a different kind of building compared to a hotel which is again very different compared to an office. Hence, the Code has requirements for different kind of buildings.

Energy efficiency requirements for the Code were derived after analysing 16 different non-residential building typologies, that in turn are broadly based on building classification in the National Building Code of India. Spatial layouts, material specifications, façade characteristics,

and occupancy patterns have an impact on energy efficiency of a building and differ for these typologies.

Potential for reducing energy use with technology and materials thus varies from building type to type. By analysing this potential, ECBC energy efficiency requirements are now sensitive to building typologies and, to the extent possible, only requirements that are feasible have been included.

Any one or more building or part of a building with commercial use is classified as per the functional requirements of its design, construction, and use. The key classification is as below:

- (a) **Hospitality:** Any building in which sleeping accommodation is provided for commercial purposes, except any building classified under Health Care. Buildings and structures under Hospitality shall include the following:
 - i. No-star Hotels – like Lodging-houses, dormitories, no-star hotels/motels
 - ii. Resort
 - iii. Star Hotel
- (b) **Health Care:** Any building or part thereof, which is used for purposes such as medical or other treatment or care of persons suffering from physical or mental illness, disease, or infirmity; care of infants, convalescents, or aged persons, and for penal or correctional detention in which the liberty of the inmates is restricted. Health Care buildings ordinarily provide sleeping accommodation for the occupants. Buildings and structures like hospitals, sanatoria, out-patient healthcare, laboratories, research establishments, and test houses are included under this type.
- (c) **Assembly:** Any building or part of a building, where number of persons congregate or

gather for amusement, recreation, social, religious, patriotic, civil, travel and similar purposes. Buildings like theatres or motion picture halls, gathering halls, and transport buildings like airports, railway stations, bus stations, and underground and elevated mass rapid transit system are included in this group.

- (d) **Business:** Any building or part thereof which is used for transaction of business, for keeping of accounts and records and similar purposes, professional establishments, and service facilities. There are two subcategories under Business – Daytime Business and 24-hour Business. Unless otherwise mentioned, Business buildings shall include both Daytime and 24-hour subcategories.
- (e) **Educational:** Any building used for schools, colleges, universities, and other training institutions for day-care purposes involving assembly for instruction, education, or recreation for students. If residential accommodation is provided in the schools, colleges, or universities or coaching/ training institution, that portion of occupancy shall be classified as a No-star Hotel. Buildings and structures under Educational shall include following types-
 - i. Schools
 - ii. Colleges
 - iii. Universities
 - iv. Training Institutions
- (f) **Shopping Complex:** Any building or part thereof, which is used as shops, stores, market, for display and sale of merchandise, either wholesale or retail. Buildings like shopping malls, stand-alone retails, open gallery malls, super markets, or hyper markets are included in this type.

(g) **Mixed-use Building:** In a mixed-use building, each commercial part of a building must be classified separately, and –

- i. If a part of the mixed-use building has different classification and is less than 10% of the total above grade floor area, the mixed-use building shall show compliance based on the building sub-classification having higher percentage of above grade floor area.
- ii. If a part of the mixed-use building has different classification and one or more sub-classification is more than 10% of the total above grade floor area, the compliance requirements for each sub-classification, having area more than 10% of above grade floor area of a mixed-use building shall be determined by the requirements for the respective building classification in §4 to §7.

Any building which does not fall under any of the categories defined above shall be classified in a category mentioned above that best describes the function of the building.

Example 2-A

A new airport is coming up in a city. What building typology will it be considered for ECBC compliance?

Answer:

As per §2.5, the airport will be classified as an 'Assembly' building type.

Example 2-B

A university campus has the following buildings.

- Library
- Hostel blocks
- Faculty housing
- Engineering college
- Sports complex

Identify which buildings are applicable for ECBC compliance

Answer:

All buildings on this campus are applicable for ECBC compliance. The hostel blocks and faculty housing, although are residential, but they are intended for a commercial purpose. These buildings are not considered as private residence. Hence will be applicable for Code compliance.

Example 2-C

A project having a built-up area of 100,000 sqm includes the following types of buildings

- 2 storey shopping complex
- 3 storey mall
- 10 storey office block
- 4 blocks of 15 storey residential buildings

Will this project be applicable for Code compliance? Identify the building typology as per the Code for this project.

Answer:

The residential buildings in the project are considered as a 'private residence'. Hence, they are not included in the scope of ECBC. All remaining buildings are applicable for Code compliance.

This project will be classified as a 'mixed-use Building' as per §2.5 where individual buildings will be classified as follows.

- 2 storey shopping complex – *Shopping complex*
- 3 storey mall – *shopping complex*
- 10 storey office block - *Business*

Each of these buildings will have to comply with the requirements for the specific building type as per the Code.



3 Compliance & Approach



COMPLIANCE AND APPROACH

INTENT

This section enumerates the overall compliance and administrative requirements for demonstrating compliance with the Code. The technical requirements are covered in detail in the subsequent chapters.

SECTION ORGANIZATION

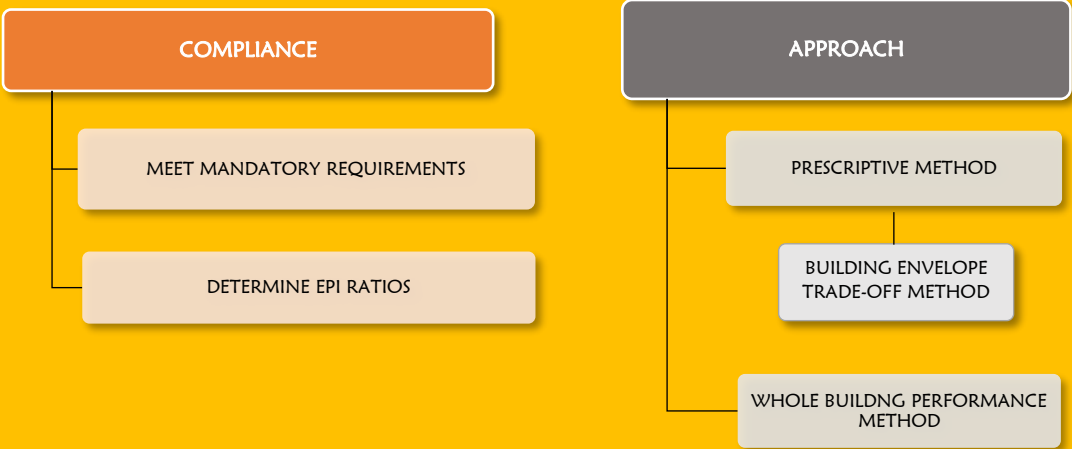

3. COMPLIANCE AND APPROACH

3.1 General

While ECBC is adopted as a national Code, the State governments can have some additional or amended requirements. Hence, when using this manual, one should check with the adopting jurisdiction for supplemental information on compliance.

To comply with Code, buildings needs to meet the following two requirements.

- 1) Comply with the mandatory requirements as per §4.2, §5.2, §6.2 and §7.2
AND
- 2) Determine the Energy Performance Index Ratio (EPI ratio) as defined in §3.1.2. To comply with the Code, buildings shall have an EPI ratio less than or equal to 1.

Determining the EPI ratio for all buildings is a major update in the Code. The EPI ratio provides a means to quantify energy performance of building. Just being Code compliant does not communicate how well the building is performing.

For example, a building having a EPI ratio of 1 denotes a Code compliant building meeting the minimum requirements. While a EPI ratio of 0.9 denotes that the building is 10% more energy efficient than a Standard Code compliant building.

Measuring energy efficiency also helps in setting goals for a better performance. For example, achieving a EPI ratio of 0.5 can be a project goal, but being Code compliant is a requirement and not a goal.

EPI ratio clearly recognizes buildings going beyond Code compliance. The intent of including the EPI ratio is to encourage project proponents to aim for better energy performance beyond Code compliance.

3.1.1 Energy Performance Index

The Energy Performance Index (EPI) is a benchmark to measure the energy performance of a building. It is the annual energy consumption in kilowatt-hours per square meter of the building. EPI can be determined by:

$$EPI = \frac{\text{annual energy consumption in kWh}}{\text{total built - up area (excluding unconditioned basements)}}$$

Lower EPI denotes a lower energy use and hence a better performance. Buildings should target to achieve as low a EPI as possible. The EPI will have to be defined first before determining the EPI Ratio.

LOWER EPI DENOTES A LOWER ENERGY USE AND HENCE A BETTER PERFORMANCE

Determining EPI

While calculating the EPI of a proposed building, the area of unconditioned basements shall not be included.

EPI can be determined by either of the following methods

- (a) Prescriptive Method including Building Envelope Trade-off Method (see §3.2.2)
- (b) Whole Building Performance Method (see §3.2.3)

If a building is opting for the prescriptive path for ECBC compliance, then it shall use the same method to determine the EPI as well.

3.1.2 Determining EPI Ratio

The EPI Ratio of a building is the ratio of the EPI of the Proposed Building to the EPI of the Standard Building:

$$EPI\ Ratio = \frac{EPI\ of\ Proposed\ Building}{EPI\ of\ Standard\ Building}$$

where,

Proposed Building is consistent with the actual design of the building and complies with all the mandatory requirements of ECBC.

A Standard Building is defined for comparing the performance of the proposed building. A standard building is defined as having the same building floor area, gross wall area and gross roof area as the Proposed Building. It complies with the mandatory requirements §4.2, §5.2, §6.2 and §7.2 and meets the minimum prescriptive requirements of §4.3, §5.3 and §6.3 for ECBC Buildings.

EPI ratio can be determined by either of the following methods

- (a) Prescriptive Method including Building Envelope Trade-off Method (see §3.2.2)
- (b) Whole Building Performance Method (see §3.2.3)

3.1.3 EPI Ratio for Core and Shell Buildings

In a core and shell building, the developer is typically responsible for the design of common areas in the base building. This could include providing mechanical, electrical and plumbing services as appropriate in areas such as lobby, corridors, restrooms, staircase and others. The tenants could have different systems installed in the area occupied by them. Hence the EPI ratio for a core and shell building shall be calculated only for the common areas using the following method

- (a) Prescriptive Method including Building Envelope Trade-off Method (see §0)
- (b) Whole Building Performance Method (see §**Error! Reference source not found.**)

Further, it is required to get a relevant undertaking from the tenants with the technical requirements clearly mentioned in the tenant lease agreement in order to comply with Code.

As per the Code,

EPI for core and shell buildings shall be calculated for the entire building based on the final design of the common areas and the relevant mandatory undertaking(s) in the tenant lease agreement for the leased areas, as per §3.1.2 or §**Error! Reference source not found.**

Example 3-A

A commercial core and shell building for office use is ECBC compliant. The tenant lease agreement states that the maximum allowable interior lighting power is 9.5 W/m². The tenant has designed the space such that the lighting power density is 8.0 W/m². Is the tenant complying with the lease agreement?

Answer:

Lower lighting power indicates less energy use. Thus, *exceeding* the maximum allowable lighting power will lead to non-compliance. Since the tenant has achieved a lighting power density lower than the requirement, the tenant space is in compliance with the lease agreement.

3.1.4 EPI Ratio for Mixed-use Development

A mixed-used building can have more than one type of building within the same structure. For example, strip retail on the ground floor and offices in the above stories of the same building. In such cases, the EPI Ratio of a mixed-use Proposed Building shall be calculated based on area-weighted average method.

Steps to calculate the EPI ratio for a mixed-use building

1. Classify each commercial part of the mixed-used building as listed in §9.5.
2. Determine the percentage of area of each classification as per the total above grade area (AGA).

$$\text{Area weightage of the sub classification} = \frac{\text{area of the sub classification}}{\text{total above grade area (AGA)}} * 100$$

3. If the sub classification is less than 10% of the total above grade area (AGA), then consider the EPI ratio of the sub-classification having highest percentage of above grade floor area.
4. If the sub classification is more than 10% of the total above grade area (AGA), then consider the EPI ratio of all the individual sub-classifications.
5. In both cases, the EPI Ratio of the mixed-use Proposed Building shall be less than or equal to Maximum Allowed EPI listed in Table 9-5 through Table 9-9.

Exceptions to the above: Any portion of a mixed-use building classified in a category which does not fall under the scope of ECBC is exempted from demonstrating compliance.

For example, a mixed-use building can have multi-family residential units and commercial spaces combined in one building. In that case, the residential units will be excluded from the scope of ECBC and the commercial part of the building will be considered for complying with the corresponding EPI ratio. If there are more than one type of spaces within the commercial part, say a supermarket and a strip retail shops, then the EPI ratio for this mixed-use commercial part should be calculated as per the area-weighted average method as explained in the above section.

Example 3-B

A 10-story commercial building project in a hot-dry climate is taking the prescriptive approach to comply with ECBC. This mixed-use building has 3 stories of shopping complex and 7 stories of office building (regular use). What is the EPI ratio this building needs to comply with?

Answer:

For the prescriptive approach, the EPI ratio will be 1 for both building types.

Note: In the case of Whole Building Performance Method, two Standard Buildings need to be defined – one for the shopping mall and the other for office building so that the Proposed Building can be compared to respective Standard Building to determine the corresponding EPI ratios.

Example 3-C

A 10-story commercial building project in a hot-dry climate is taking the prescriptive approach to comply with ECBC. This mixed-use building has 3 stories of shopping complex and 7 stories of office building (regular use). What is the EPI ratio this building needs to comply with to achieve the ECBC+ performance level?

Answer:

Step 1: Since this is a mixed-use building, each commercial part needs to be first classified as per §9.5. This building has the following types of buildings

- 1) shopping mall
- 2) office building (regular use)

Step 2: find out the percentage of area relative to the AGA

Shopping mall – 30%

Office building – 70%

Step 3: Since each sub-classification is greater than 10%, EPI ratios for each building type should be considered as per **Error! Reference source not found.** for hot-dry climate.

Thus,

EPI ratio of shopping mall = 0.84

EPI ratio of office (regular use) = 0.86

If the mixed-use building meets the prescriptive requirements as per §4.3, §5.3, **Error! Reference source not found.**, **Error! Reference source not found.** and §6.3 for the respective building type, it will be deemed to have a EPI ratio of 0.84 for the shopping mall and 0.86 for the office.

3.2 Compliance Approaches

Buildings that fall within the scope of the Code as mentioned in §2, shall comply with the Code by meeting all the mandatory requirements (see §3.2.1) using any of the compliance paths mentioned in §3.2.2 or §3.2.3.

3.2.1 Mandatory Requirements

Buildings shall comply with all mandatory requirements mentioned under §4.2, §5.2, §6.2 and §7.2, irrespective of the compliance path.

3.2.2 Prescriptive Method

A building complies with the Code using the Prescriptive Method if it meets the prescribed minimum (or maximum) values for envelope components (§4.3), comfort systems and controls (§5.3, §Error! Reference source not found., §Error! Reference source not found.), and lighting and controls (§6.3), in addition to meeting all the mandatory requirements.

This approach does not offer much flexibility in design compared to the Whole Building Performance Method since the prescribed values for individual elements need to be met.

3.2.2.1 EPI Ratio through Prescriptive Method

In the prescriptive approach, the energy use of a building cannot be quantified in absolute terms. However, the performance can be compared to a Standard building and expressed as EPI ratio. As per the Code,

ECBC Buildings that demonstrate compliance through Prescriptive Method (§3.2.2) shall be deemed to have an EPI equal to the Standard Building EPI, and therefore an EPI Ratio of 1.

Thus, the EPI ratio of ECBC building is 1 for all building types across all climate types because it is equal to the Standard Building for the

corresponding building and climate type. EPI ratio of 1 denotes that the building has met the minimum set of requirements for Code compliance.

EPI RATIO OF ECBC BUILDING IS 1

As per the Code, ECBC+ Buildings and SuperECBC Buildings that demonstrate compliance through Prescriptive Method shall be deemed to have an EPI Ratio equal to the EPI Ratios listed in §9.5 under the applicable building type and climate zone.

Thus, EPI ratios of ECBC+ and SuperECBC buildings are always less than 1. It varies from 0.91 to 0.66 for specific building types in different climate zones as per §9.5. For example, the EPI ratio for a supermarket in a composite climate is 1 for Code compliance. If the same building aims for a ECBC+ performance, then the maximum allowed EPI ratio is 0.81 and for the SuperECBC performance level, it is 0.68. This means, the SuperECBC building is 32% more energy efficient than a Code compliant ECBC building.

3.2.2.2 Building Envelope Trade-off Method

The design of the building envelope generally demands more flexibility. The Building Envelope Trade-off Method offers some flexibility to the prescriptive approach where improvement in one component can compensate for the lack of it in another component within the building envelope only.

As per the Code,

Building Envelope Trade-off Method may be used in place of the prescriptive criteria of §4.3.1, §0 and §4.3.3. A building complies with the Code using the Building Envelope Trade-off Method if the Envelope Performance Factor (EPF) of the

Proposed Building is less than or equal to the EPF of the Standard Building, calculated as per §4.3.5, in addition to meeting the prescriptive requirements for comfort systems and controls (§5.3, §Error! Reference source not found., §Error! Reference source not found.), and lighting and controls (§6.3), and all the mandatory requirements (§4.2, §5.2, §6.2 and §7.2).

3.2.2.3 Total System Efficiency Method

Just like the building envelope, the air-conditioning systems also demand more flexibility in design, especially in the case of a chilled water plant in large buildings. The Code offers flexibility to comply with efficiency at the plant level rather than comply with requirements of individual components.

As per Code,

For projects using central chilled water plants, the Total System Efficiency approach may be used to comply with the Prescriptive Method of §5. This approach may be used in place of the prescriptive criteria of chillers (§5.3.1 and §5.3.6), chilled water pumps (§5.3.2), condenser water pumps (§5.3.2), and cooling tower fan (§5.3.3). Per this approach, a building complies if the Total System Efficiency thresholds are met as per Table 5-23 Maximum System Efficiency Threshold for ECBC, ECBC+, and SuperECBC Buildings. Compliance with other prescriptive requirements (§5.3), as applicable, shall be met.

3.2.2.4 Low Energy Comfort Systems

There are many non-refrigerant based alternative comfort systems such as radiant cooling, evaporative cooling, structure cooling and others which find application in various climate zones. The Code has a provision to show compliance for such low energy comfort systems.

As per the Code,

Low Energy Comfort Systems (§5.3.13) is a simplified approach that provides projects using Low Energy Comfort Systems an opportunity to achieve improved compliance levels of ECBC+ and SuperECBC. This approach is applicable to Prescriptive Method of Section §5. In addition to compliance with the applicable prescriptive requirements (§5.3), the projects must meet the sum of cooling and heating requirement using approved list of low energy systems as per requirements in §5.3.13.

3.2.3 Whole Building Performance Method

The Whole Building Performance Method (WBP) offers complete flexibility in demonstrating compliance. In this approach, the individual elements are not assessed for compliance. Instead the entire building as a system is assessed for its performance.

In the WBP method, compliance is achieved by first meeting the mandatory requirements in §4 through §7. After that, the estimated annual energy use of the Proposed Design must be determined which should be less than that of the Standard Design.

As per the Code,

A building complies with the Code using the Whole Building Performance (WBP) Method when the estimated annual energy use of the Proposed Design is less than that of the Standard Design, even though it may not comply with the specific provisions of the prescriptive requirements in §4 through §7. The mandatory requirements of §4 through §7 (§4.2, §5.2, §6.2 and §7.2) shall be met when using the WBP Method.

Example 3-D

Building A and Building B are office buildings. Both have complied with all the mandatory requirements of the Code. Building A has an EPI ratio of 0.86 as determined by the prescriptive method. Building B has an EPI ratio of 1 as determined by the WBP method.

Which building is more energy efficient?

Answer:

Building A is more energy efficient because it's has a lower EPI ratio. The compliance approach taken to determine the EPI ratio does not make a difference. The EPI ratios can be compared between buildings of the same type to determine the better performing building.

means that the hospital is achieving the ECBC+ building with a EPI ratio of 0.80. While in the prescriptive approach, the EPI ratio of the hospital building will be deemed to be 0.85 for ECBC+ performance level.

For convenience, the tables from §9.5 has been reproduced here

3.2.3.1 EPI Ratio through Whole Building Performance Method

Energy simulation tools are used in the Whole Building approach which makes it possible to quantify the energy use of a building in kWh and hence the exact EPI can be calculated.

The EPI of buildings that demonstrate compliance through Whole Building Performance Method (§3.2.3) shall be calculated using the compliance path defined in §3.1.1 and detailed in §0. The EPI Ratio of a building that uses the Whole Building Performance Method to show compliance, should be less than or equal to the EPI Ratio listed in §9.5 for the applicable building type and climate zone.

The benefit in this approach is that the exact EPI ratio can be calculated for the building. For example, the calculated EPI ratio for a hospital using the Whole Building Performance approach is 0.80 while the maximum allowed EPI ratio by the Code with ECBC+ performance is 0.85. This

Table 9-5 Maximum Allowed EPI Ratios for Building in Composite Climate

Table 9-8 Maximum Allowed EPI Ratios for Buildings in Warm and Humid Climate

Table 9-6 Maximum Allowed EPI Ratios for Buildings in Hot and Dry Climate

Table 9-7 Maximum Allowed EPI Ratios for Buildings in Temperate Climate

DRAFT

Table 9-9 Maximum Allowed EPI Ratios for Buildings in Cold Climate

New core and shell building shall demonstrate compliance with ECBC requirements for the following base building systems in the common areas.

3.3 Compliance Requirements

3.3.1 New Building Compliance

3.3.1.1 Full building Compliance

The main focus of the ECBC is on new buildings. Every building project is unique and the designer needs to address specific issues of building design and still comply with the Code. Hence the Code offers flexibility by providing multiple compliance approach.

New buildings with completed fit-outs shall comply with either the provisions of §4 through §7 of this Code or the Whole Building Performance Method of §0.

3.3.1.2 Core and Shell building Compliance

Core and Shell buildings have tenant occupied spaces. Hence the compliance is limited to the base building systems in the common areas that is in the scope of the builder/developer.

To ensure that, the Code requires a tenant lease agreement with a legal undertaking clause to ensure interior fit-outs made by tenants shall be Code compliant.

The legal undertaking shall mandate the relevant energy efficiency compliance requirements for all interior fit-outs within the tenant leased area, including, but not limited to, §5.2.1, §5.2.2.2, §5.2.2.3, §5.2.2.5, §0 and §7.2.4.

ECBC addresses existing buildings in certain aspects such as new addition or an alteration as discussed below.

3.3.2 Additions and Alterations to Existing Buildings

An addition is a new floor, wing or a block that extends or increases the area or height of the existing building. An example of an alteration could be a change in converting an unconditioned space to a conditioned space.

The Code is applicable when the connected load of the addition or the alteration plus the existing building exceeds 100kW or of connected load or 120 kVA of contract demand.

The new addition should meet the mandatory requirements as per §4 through §7. After that, the Code compliance can be shown either through the prescriptive or the WBP approach. The Code does not require any changes to be made to the existing building

As per the Code,

Compliance may be demonstrated in either of the following ways:

- (a) The addition shall comply with the applicable requirements, or
- (b) The addition, together with the entire existing building, shall comply with the requirements of this Code that shall apply to the entire building, as if it were a new building.

Exceptions to §3.3.2: When space conditioning is provided by existing systems and equipment, the existing systems and equipment need not comply with this code. However, any new equipment installed must comply with specific requirements applicable to that equipment.

For example, three new floors have been added to an existing building. The addition is being served by the existing chillers that is supplying chilled water to the existing building. In this case, the chiller does not need to comply with the Code, but any new air distribution equipment installed in the addition need to comply with the Code. However, if a new chiller has to be installed due to an addition, then the chiller must also comply with the Code.

The simplest compliance method for additions and alterations is to treat the addition as if it were its own separate building.

3.4 Approved Analytical Tools

A building following the whole building performance method or Total System Efficiency

– Alternate Compliance Approach essentially requires the use of computer simulation tools that help estimate the energy use of a building. Only BEE approved software tools can be used to show compliance.

The compliance can also be shown through the BEP-EMIS online tool. The Building Energy Passport (BEP) - Energy Monitoring Information System (EMIS) is an online platform for ECBC compliance. The platform has forms and calculators built into it that streamlines the documentation as well as assessment for compliance.

Compliance to the daylight requirements of §4.2.3, if calculated through software tools, shall be shown through online BEP-EMIS or daylighting software approved by BEE.

The list of BEE approved software for whole building energy simulation and daylighting analysis is given in Appendix E: BEE approved list of software to show compliance.

3.5 Administrative Requirements

Administrative requirements, including but not limited to, permit requirements, enforcement, interpretations, claims of exemption, approved calculation methods, and rights of appeal are specified by the authority having jurisdiction.

3.6 Compliance Documents

3.6.1 Compliance Documents

Thorough documentation is essential for a smooth approval process. Documentation of compliance can be shown through drawings, technical data, specification, material brochure, calculations, report and any other supporting material.

As per the Code,

Construction drawings and specifications shall show all pertinent data and features of the building, equipment, and systems in sufficient detail to permit the authority having jurisdiction to verify that the building complies with the requirements of this code. Details shall include, but are not limited to:

- (a) Building Envelope: opaque construction materials and their thermal properties including thermal conductivity, specific heat, density along with thickness; fenestration U-factors, solar heat gain coefficients (SHGC), visible light transmittance (VLT) and building envelope sealing documentation; overhangs and side fins, building envelope sealing details;
- (b) Heating, Ventilation, and Air Conditioning: system and equipment types, sizes, efficiencies, and controls; economizers; variable speed drives; piping insulation; duct sealing, insulation and location; solar water heating system; requirement for balance report;
- (c) Lighting: lighting schedule showing type, number, and wattage of lamps and ballasts; automatic lighting shutoff, occupancy sensors, and other lighting controls; lamp efficacy for exterior lamps;
- (d) Electrical Power: electric schedule showing transformer losses, motor efficiencies, and power factor correction devices; electric check metering and monitoring system.
- (e) Renewable energy systems: system peak generation capacity, technical specifications, solar zone area

Compliance forms have been provided in Appendix D: Compliance Forms to facilitate the process of compliance and check.

3.6.2 Supplemental Information

The authority having jurisdiction may require supplemental information necessary to verify compliance with this code, such as calculations, worksheets, compliance forms, manufacturer's literature, or other data.

4 Building Envelope

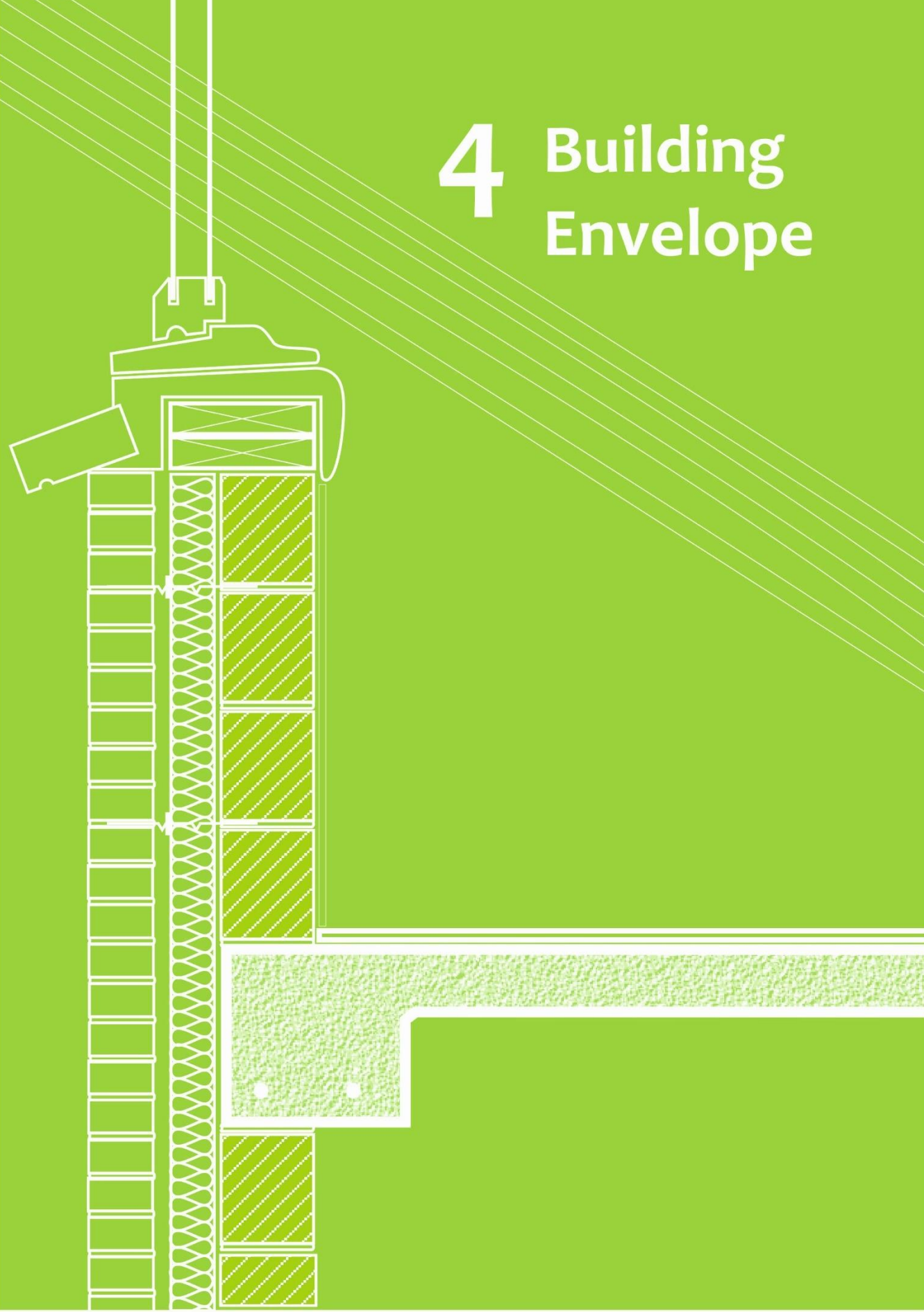

BUILDING ENVELOPE

INTENT

Thermal loads determine the amount of cooling and/or heating required to keep occupants comfortable in a building. The first step in achieving energy efficiency is to reduce thermal loads through good building envelope. This can be achieved by ensuring good thermal resistance, blocking direct solar radiation and ensuring good daylighting.

SECTION ORGANIZATION

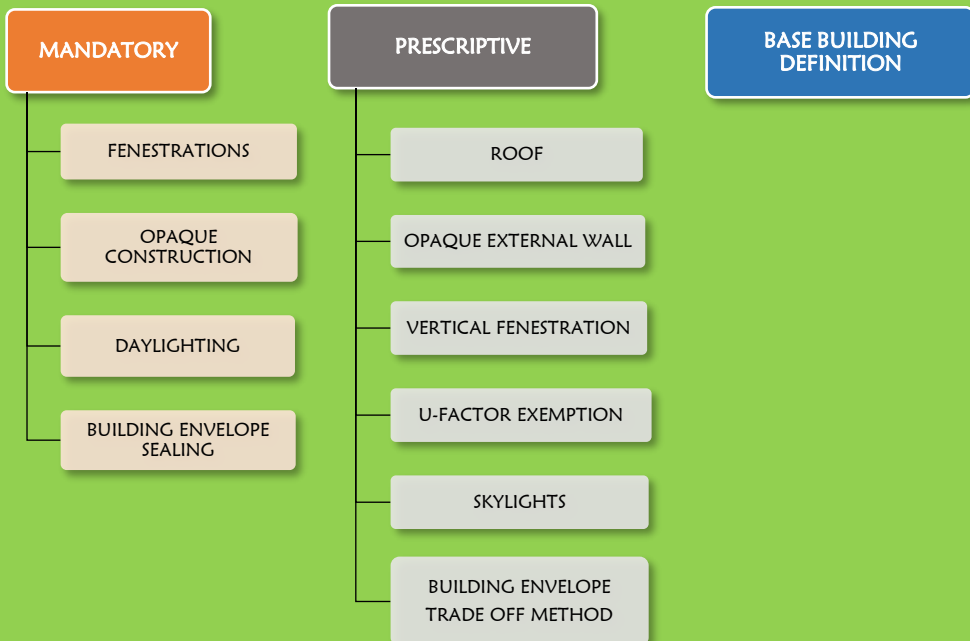

4. BUILDING ENVELOPE

4.1 General

The exterior façade of the building including opaque elements and fenestrations is called the building envelope (Figure 4.1). Opaque elements include exterior walls, roof, slab on grade, basement walls and exterior doors. Fenestration systems include windows, skylights, ventilators, and doors that are more than one-half glazed.

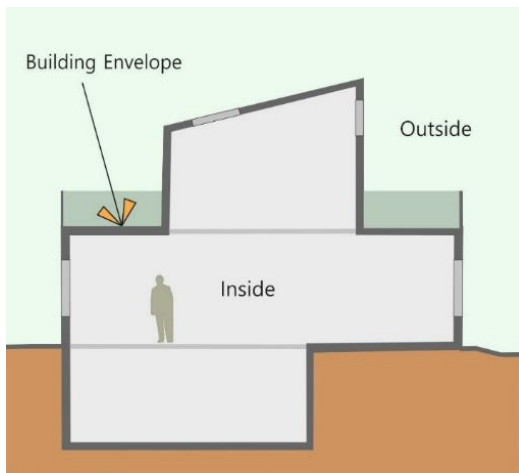

Figure 4.1 Building Envelope

Building envelope provides a physical as well as a thermal barrier to the exteriors. The envelope itself does not use any energy directly but its design will determine the amount of heating and cooling required by building.

For example, an adequately shaded window bringing in good daylighting and blocking direct solar radiation will have two benefits – daylighting will reduce the need for electric lighting and shading will reduce the cooling requirement. Such design will eventually impact the energy use of the building. Hence, thermally efficient envelope is imperative to achieving energy efficiency.

Building heat transfer

According to the second law of thermodynamics, heat flows from a hotter region to a cooler region until it reaches a state of equilibrium. In summer, during daytime, heat will flow from the cooler interiors to the warm exteriors. In winter, during night time, heat would most likely flow from warm interiors to the cold exteriors (Figure 4.2). This results in temperature fluctuations inside the building. Energy is used in countering these fluctuations to maintain a comfortable temperature inside the building. Understanding heat flow is fundamental to designing a good envelope to provide comfort with energy efficiency.

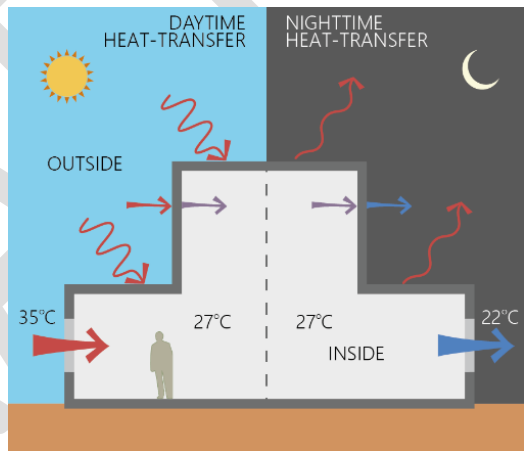

Figure 4.2 Heat transfer through building

Heat transfer across a building envelope takes place through conduction, convection and radiation.

Conduction is the heat transfer through a solid medium due to temperature difference. There are two things required for conduction to take place – surface contact and temperature difference. For example, heat transfer across a 230mm brick wall will take place due to temperature difference across the wall (Figure 4.3). Heat will be transferred from one brick molecule to the other that are in contact.

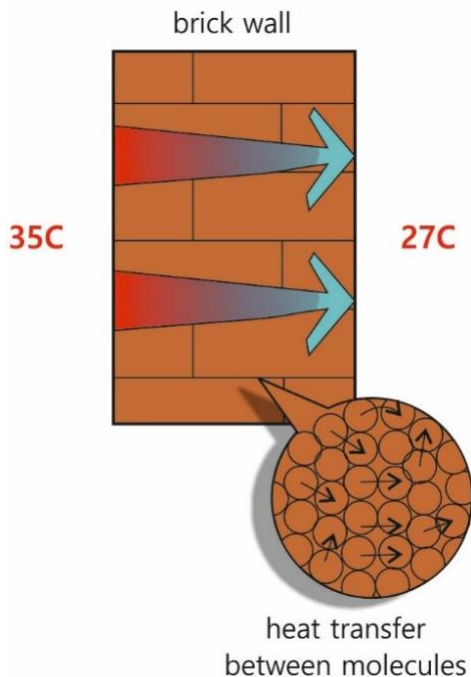

Figure 4.3 Heat transfer through conduction

The rate of heat transfer is determined by the material property. Ideally, we want the building envelope to be a bad conductor of heat so that heat gains or losses can be minimized. This will result in a largely stable temperature inside the building which is desired for occupant comfort.

Convection is the heat transfer through a fluid medium such as air or water. Convection within the envelope assembly will depend on the temperature difference across the surfaces and also the air speed.

For example, heat transfer across an air gap within a wall will take place through convection (Figure 4.4). The heated exterior wall surface transfers heat to the air film on surface 2. Warm air becomes buoyant and starts moving and transferring heat to the cooler air molecules. Thus, warm air moves upwards and the cool air falls downward resulting in a cyclical movement within the wall cavity. This air movement within the cavity transfers heat from surface 2 to 3

through convection. This movement will continue until there is no temperature difference.

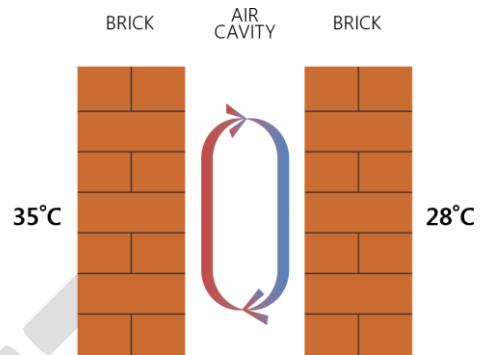

Figure 4.4 Heat transfer through convection

In a roof assembly, the air gap, if present, will be horizontal. Convection will take place similar like the wall. In Case 1 shown in Figure 4.5 the warm air is being formed at the bottom surface. It will become less-dense and start moving upwards while the cooler dense air will fall down forming a cyclical motion just like the wall cavity.

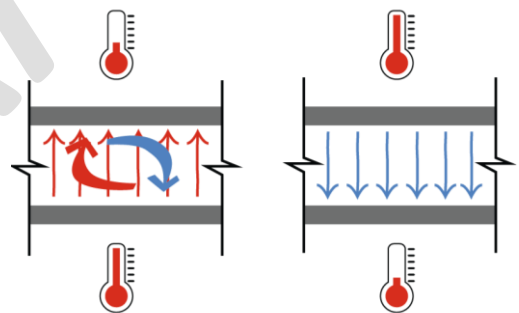

Figure 4.5 Convection in horizontal spaces

In Case 2, the warm air is being formed at the upper surface. Being less dense than the cooler air it will not move downwards and will become stagnant near the upper surface. In this scenario, convection will be negligible and heat transfer will take place by radiation in downward direction from the warmer surface to cooler one. Radiation is explained in the further sections.

Good design should minimize convection within the envelope assembly.

Convection also occurs within the building. In naturally ventilated buildings, convection occurs when outside air enters the buildings through openable fenestrations and either warms up or cools the interiors through air movement (Figure 4.6).

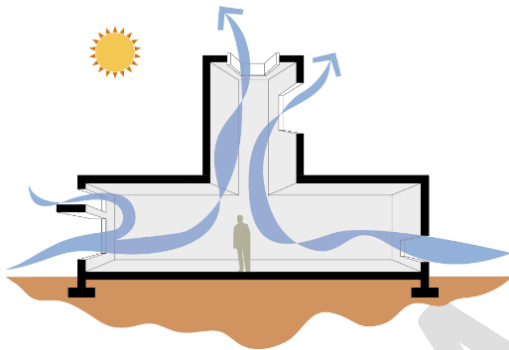

Figure 4.6 Convection through ventilation

In tall spaces, warm air tends to rise and accumulate near the ceiling due to the same principle of buoyancy (Figure 4.7). This is called stratification which is a result of convection.

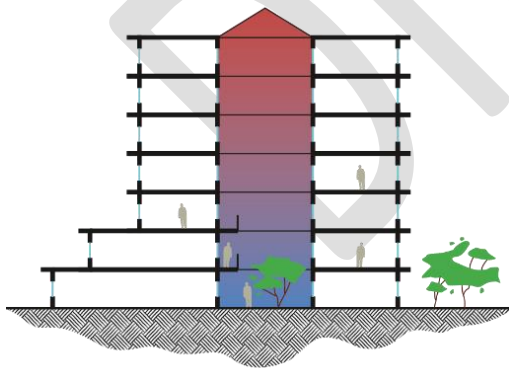

Figure 4.7 Stratification in atrium space

Exhausting the warm air from higher outlet will create a pressure difference to pull in cool air from the lower inlet. This is a forced convection strategy in passive building design to assist air

flow inside the building. In such cases, convection is desired to ensure air movement for comfort.

In a closed mechanically conditioned building, convection can take place by air entering or exiting through window cracks and other construction joints (Figure 4.8). When warm outside air enters the interiors, it adds heat to the space which eventually increases the cooling requirement. Similarly, when cold outside air enters the warm space in winters, it will increase the heating requirement. This is called infiltration which is desired to be minimized in energy efficient buildings.

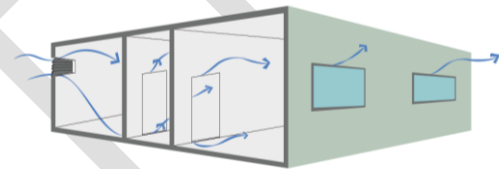

Figure 4.8 Infiltration

Radiation is the heat transfer through electromagnetic radiation. All bodies facing an air space or a vacuum emit and absorb radiant energy continuously. Heat transfer by radiation will take place from a warmer surface to a cooler one. For example, if you are sitting close to a fire place, you feel warm because your body is gaining heat by radiation.

In the context of energy conservation, it is important to understand solar radiation and its impact on buildings. Solar radiation is an electromagnetic wave comprising of ultraviolet, visible and infrared radiation. The 'solar infrared' component has a short wavelength primarily due to its very high temperature.

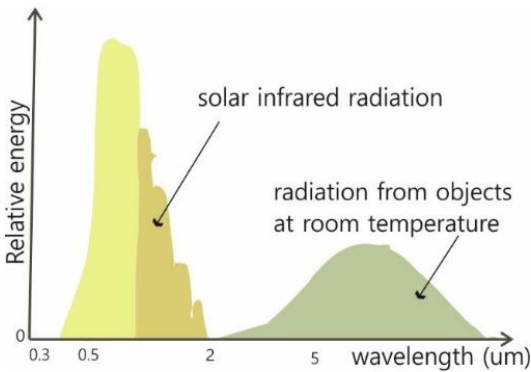

Figure 4.9 Solar radiation spectrum

When the 'solar infrared' component comes in contact with earth or any object or a building, it transfers its energy to the object/building in the form of heat. This phenomenon is known as solar radiation heat transfer. This heat transfer from sun to other objects or surface is always in the form of shortwave infrared radiation.

Opaque objects and transparent object interact differently with radiation.

When solar radiation is incident on the roof, the outer surface becomes warm and starts conducting heat through the material. When the inner surface becomes warm, it starts transferring heat as long wave radiation inside the room (Figure 4.9). Similarly, the outer surface of the roof starts losing heat through radiation to the atmosphere as long wave infrared radiation. This phenomenon is called thermal emittance.

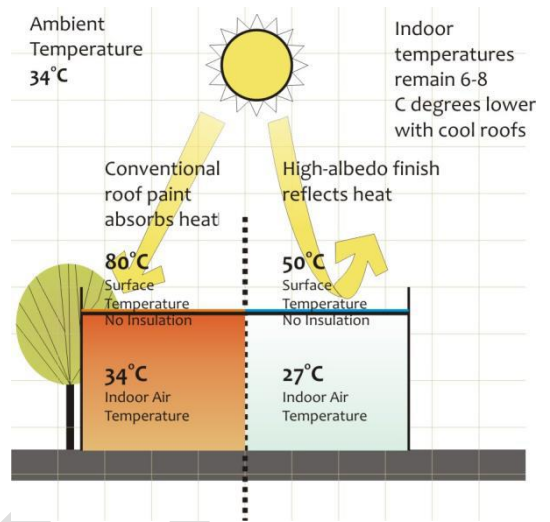

Figure 4.10 Radiation heat transfer through roof

During nighttime, the process is reversed. The outside surface of the roof start radiating heat towards the cool night sky.

Radiation is affected by the surface property of the material. For example, light colored surface will absorb less heat compared to a dark colored surface consequently impacting the overall heat content of the material.

Transparent materials such as glass interacts very differently with solar radiation (short wavelength) than with long wave infrared radiation.

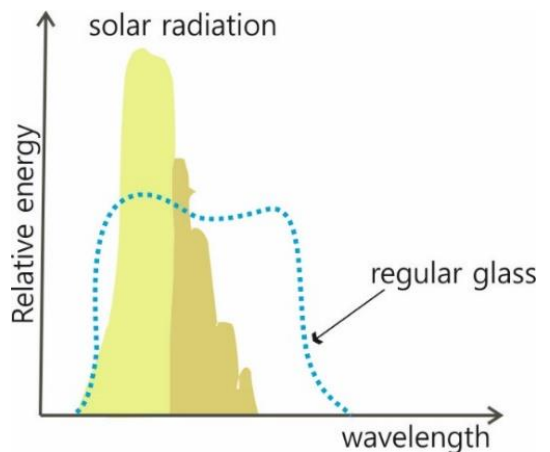

Figure 4.11 Glass and radiation

Glass is “selective” in what can pass through it. The high temperature short-wave solar radiation is able to pass right through a regular clear glass and ends inside the space as heat. As the objects inside the space get warmed, they start emitting radiation in the long-wave infrared spectrum. As shown in Figure 4.11, glass is opaque to the long-wave infrared radiation and hence it traps a part of this energy and the room slowly heats up. This is called the *greenhouse effect*. This is the reason spaces enclosed by glass in a hot climate need increased air conditioning.

Material property that affect conduction:

Conductance, denoted as **C**, is the ability of a material to encourage heat flow. Conductance is the number of Watts of heat that flow through a given thickness of a material when the temperature difference across the material is 1°C. Units are W/m² K. Sometimes, **conductivity** or the **k value** of the material could be given using which Conductance can be calculated. The conductivity of the material denotes the rate of heat transfer for a unit thickness when the temperature difference across the material is 1°C.

Example 4-A

Calculate conductance for 345mm brick wall. The k-value of fired brick with a density of 2400 kg/m³ is 1.21 W/m K.

Answer:

Conductivity $k = 1.21 \text{ W/m K}$

$x = 345\text{mm} = 0.345 \text{ m}$

Conductance $C = k/x$
 $= 1.21/0.345$
 $= 3.5 \text{ W/m}^2 \text{ K}$

Thus, the conductance of 345mm brick wall is 3.5 W/m² K

U-factor - In practice, a wall or roof assembly is usually a combination of more than one kind of material. For example, a brick wall can have plaster on the exterior and interior side or it could also have a granite cladding on the exterior and plaster on the interior. In such cases, the total conductance of the assembly should be calculated. This is called **U-factor** which is the *overall* coefficient of heat transfer. Units are W/m² K.

Thus, U-value is the sum of conductance of each material of the assembly.

$$U = C_1 + C_2 + C_3 + \dots + C_n$$

Thus, $U = \Sigma C$

Where,

C₁, C₂, C_n are the conductance of individual layers of the assembly.

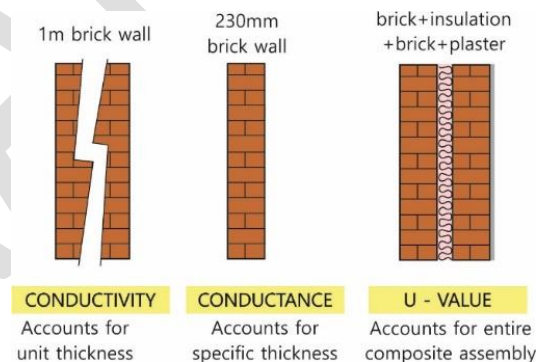

Figure 4.12 Conductance and U-value

U-factor takes into account the conductance of each material of the assembly. It does not include the effect of moisture related heat flow. An example of how the U-value for an assembly can be calculated is shown in Example 4-B.

The ECBC specifies minimum U-value for roof and walls that are above grade.

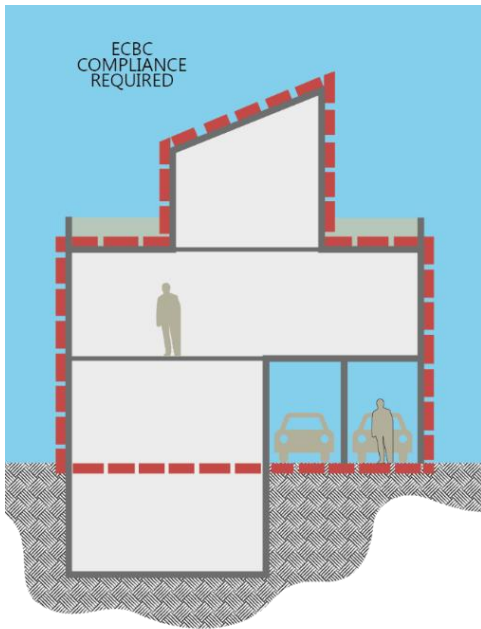

Figure 4.13 ECBC scope of compliance

A GOOD ENVELOPE DESIGN WILL USE MATERIALS WITH LOWER U-FACTOR

Resistance, denoted as R , is the ability of a material to resist heat flow. It is the reciprocal of conductance. Units are $m^2 \text{ }^\circ\text{K/W}$. The effectiveness of a material as an insulator is denoted by R-value. If the material thickness increases, the resistance also increases. When materials are placed in series, their thermal resistances are added so that the same area conducts lesser heat for a given temperature difference.

A GOOD ENVELOPE DESIGN WILL USE MATERIALS WITH HIGHER R-VALUE

To calculate the R-value of an assembly, the individual resistances of each material should be calculated and a summation of these will give the final R-value as per the following formula.

$$R_t = R_{si} + R_1 + R_2 + \dots + R_n + R_{se}$$

Where,

- R_t = Total thermal resistance of the assembly
- R_{si} = Interior surface thermal resistance
- R_{se} = Exterior surface thermal resistance
- R_1, R_2, R_n are the thermal resistance of individual layers of the assembly.

U-factor is the reciprocal of R-value.

$$U = \frac{1}{\Sigma R}$$

At exposed surfaces of solids, both on the exterior and interior, a thin film of air “attaches” itself to the surface offering some thermal resistance. This thin film of still air can offer resistance equivalent to that of a thickness of 1/2 inch or 12.7mm plywood (Grondzik, et al. 2009). When this air film gets disturbed, such as the case of wind blowing over the surface, its resistance drops down quickly and the air movement starts convecting heat, thus leading to heat transfer.

Table 4 A Values of surface film resistance based on direction of heat flow

R_{si}			R_{se}		
Direction of heat flow			Direction of heat flow		
Horizontal	Up	Down	Horizontal	Up	Down
0.13	0.10	0.17	0.04	0.04	0.04

R-value is especially useful when comparing insulation materials such as extruded polystyrene, rockwool and others.

Air spaces within the wall and roof construction add resistance to overall assembly and they need to be accounted for while calculating the U-value.

Table 4 B Thermal resistances of unventilated layers between surfaces with high emittance

Thickness of air layer (mm)	Thermal Resistance (m ² .K/W)		
	Direction of Heat Flow		
	Horizontal	Up	Down
5	0.12	0.10	0.10
7	0.12	0.12	0.12
10	0.14	0.14	0.14
15	0.16	0.16	0.16
25	0.18	0.17	0.18
50	0.18	0.17	0.20
100	0.18	0.17	0.20
300	0.18	0.17	0.21

For ECBC compliance, the U-value of the roof and wall assembly need to be calculated. Sample calculations are shown in Example 4-B.

Example 4-B

Calculate the U-value for the cavity wall construction shown below.

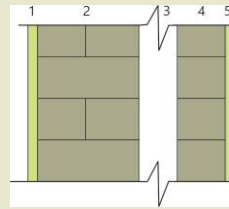

- Layer 1 : 25mm cement plaster
- Layer 2 : 230mm AAC wall
- Layer 3 : 100mm air gap
- Layer 4 : 115mm AAC wall
- Layer 5 : 13mm cement plaster

Answer:

Resistance for each layer can be calculated as follows

$$R1: x_1/k_1 = 0.025/1.208 = 0.02 \text{ m}^2 \text{ K/W}$$

$$R2: x_2/k_2 = 0.230/0.183 = 1.25 \text{ m}^2 \text{ K/W}$$

$$R3: 0.18 \text{ m}^2 \text{ K/W}$$

$$R4: x_4/k_4 = 0.115/0.183 = 0.62 \text{ m}^2 \text{ K/W}$$

$$R5: x_5/k_5 = 0.013/1.208 = 0.01 \text{ m}^2 \text{ K/W}$$

$$R_t: R\text{-value for the composite wall} \\ = R1+R2+R3+R4+R5 = 2.08 \text{ m}^2 \text{ K/W}$$

$$R_T = R_{se} + R_t + R_{si} = 0.13+2.45+0.04 = 2.25 \text{ m}^2 \text{ K/W}$$

$$U = 1/ R_T = 1/2.62 = 0.44 \text{ W/m}^2 \text{ K}$$

Material property that affect radiation

Radiation is affected by the surface of a material. The exterior finishes, be it paint or a kind of surface texture impacts the heat gain due to radiation. For example, shiny surfaces are able to reflect more heat than rough surfaces.

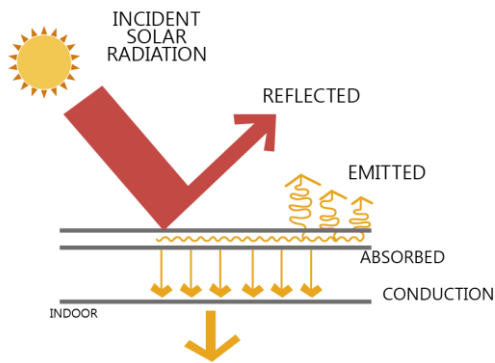

Figure 4.14 Material interaction with radiation

Reflectance is the ability of a material to reflect radiation without changing the temperature of the material. Surfaces with higher reflectance tend to absorb less heat.

Solar reflectance is the ratio of solar energy that is reflected by a surface to the total incident solar radiation on that surface. Solar reflectance is measured on a scale from 0 to 1. A reflectance value of 0 indicates that the surface absorbs all incident solar radiation, and a value of 1 denotes a surface that reflects all incident solar radiation.

The term ‘albedo’ is often used interchangeably with solar reflectance. High albedo or reflective surfaces stay much cooler than low albedo or less reflective surfaces.

Absorptance is the ability of a material to absorb radiation. This is converted into sensible heat within the material, thus raising its temperature. It is measured on a scale from 0 to 1. A value of 0 indicates that the surface reflects all incident solar radiation, and a value of 1 denotes a surface that absorbs all incident solar radiation. Thus, highly reflective surface will have very less absorptance.

$$\text{ABSORPTION} + \text{REFLECTION} = 1$$

Thus, radiation that does not get reflected, is absorbed.

Emissance is the ability of a material to re-radiate absorbed heat as invisible infrared radiation. It indicates the ability of a material to lose heat, consequently reducing the sensible heat content of the object.

Emissance, measured from 0 to 1, is defined relative to a black body with an emissance of 1. Some materials can emit more effectively than others. Polished metal surfaces have low emissances than most other materials.

Emissance and absorptance are not necessarily proportional, but they impact the sensible heat content in a material. Materials can absorb and emit at different wavelengths. For example, white paint absorbs 20% of the shortwave radiation from the sun and absorbs 80% of the long wave radiation from heated objects.

The emissivity of building material, unlike reflectance, is usually measured in the far infrared part of the spectrum.

A simple strategy like selecting the right color for external wall and roof can impact the heat radiation through radiation.

Table 4 C Surface color and absorptivity

Category	Light	Medium	Dark	Black
Absorptivity Factor	<0.5	0.5 - 0.7	0.7- 0.9	>0.9
Colors	White	Dark red	Brown	Black
	cream	Light green	Dark green	Dark brown
		Orange	Light blue	Vivid blue
		Light red		Dark blue

Different surface finishes and their properties impact radiation heat gain are given in the following table.

Table 4 D Material properties

Building Element Surface	Absorptance (solar radiation)	Emissivity (thermal radiation)
Lime sand stone, gray	0.60	0.96
Concrete, smooth	0.55	0.96
Brick facing, red	0.54	0.93
Aluminium, raw	0.2	0.05
Aluminium anodised	0.33	0.92
Plaster, white	0.21	0.97
Plaster, gray, blue	0.65	0.97
Glass	0.08	0.88
Paint, White	0.25	0.95

Building thermal loads

All buildings are subject to thermal loads. Just like a building is designed to meet the structural loads, it should also be designed to meet the thermal loads. Thermal loads depend on the climate, the building envelope and what is inside the building.

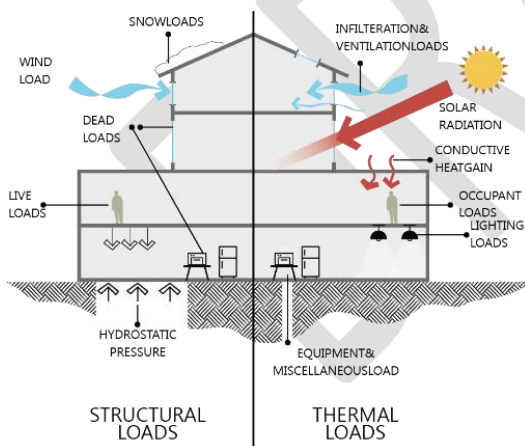

Figure 4.15 Analogy of thermal loads and structural loads

Thermal loads or *heat loads* denote the amount of cooling or heating required to provide occupant comfort. It is called *heat loads* because primarily, heat is either removed from the space

for cooling or added to the space for heating. Thus, heat loads are specifically referred to as *cooling loads* and *heating loads*.

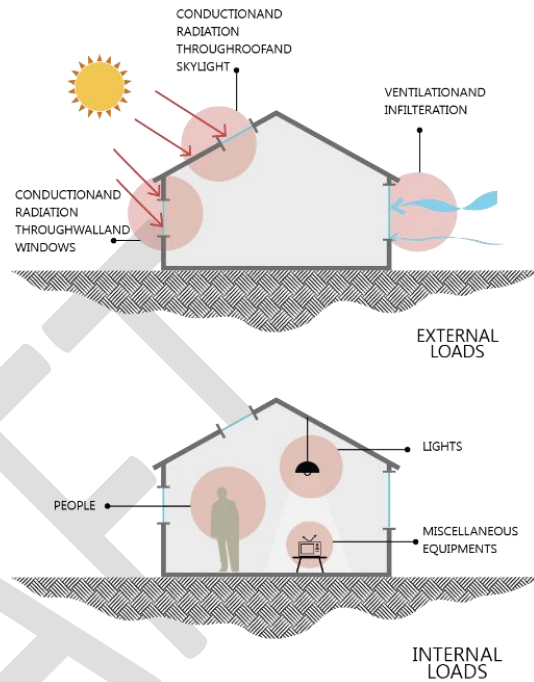

Figure 4.16 Internal and external loads

It takes energy to either add heat to remove heat. Hence larger thermal loads will mean more energy used by the building to provide thermal comfort.

Climate plays a very important role in determining thermal loads. A building located in a hot and dry climate will need more cooling compared to a moderate climate. This is called *external loads*.

The envelope design must try to counter the external loads by proper thermal design of the walls, roof and fenestrations. The property of these materials will determine the heat gain from outside to inside. This is called *envelope load*. For example, a glass curtain wall will result in more heat gain as compared to 230mm brick wall of the same area. Thus, the envelope load of

a 80% glazed building is larger than a 30% glazed building with more opaque walls. If such a building was located in a hot-humid climate, then the cooling load for the 80% glazed building will be much larger than the 30% glazed building. Moreover, shading elements impact the heat gain as well.

People, lights and equipment inside a building add heat to the space. This is called **internal loads**. For example, the internal loads of a hotel will be larger than that of a school since there will be more lights, equipment and people on hotel. Except for the number of people using a building, all other aspects can be controlled by building design.

Thus, building design including the form, orientation, wall and roof construction, fenestration area, shading devices, surface finishes, lighting design, equipment efficiency, etc. plays a significant role in determining the thermal loads. The design process for sustainable and energy efficient buildings requires that such design decisions are taken during early stage design process.

The ECBC gives minimum requirements for building envelope to meet the thermal loads as per different climate.

BUILDING DESIGN WILL DETERMINE THE HEATING AND COOLING LOADS

4.2 Mandatory Requirements

4.2.1 Fenestration

Heat transfer across fenestration through conduction and convection is similar like walls and roof. Heat gain through direct solar radiation is unique to fenestrations which should be

understood clearly since it is a significant factor in determining the cooling loads of buildings.

The three criteria that determine the thermal performance of the fenestration are explained below:

- 1) U-factor
- 2) SHGC
- 3) VLT

4.2.1.1 U-factor

U-factors shall be determined for the overall fenestration product (including the sash and frame) in accordance with ISO-15099 by an accredited independent laboratory and labeled or certified by the manufacturer.

For Code compliance, the U-factor must account for the entire fenestration system including the effects of the frame, the spacers in the glazing.

In the U.S, the fenestration U-factors are determined in accordance with the National Fenestration Rating Council (NFRC) Standard 100. NFRC is a membership organization of window manufacturers, researchers, and other that develops, supports, and maintains fenestration rating and labeling procedures. Most fenestration manufacturers have their products rated and labeled through the NFRC program. Certified products receive an 8.5"x11" NFRC label that the enumerates the U-factor, SHGC and the VLT.

4.2.1.2 Solar Heat Gain Coefficient

The ECBC requires that SHGC be determined in accordance with ISO-15099 by an accredited independent laboratory, and labeled and certified by the manufacturer. Designers should insist on getting SHGC data from manufacturers.

Shading Coefficient (SC) and SHGC

SHGC has replaced the term Shading Coefficient (SC) that was being used earlier to quantify the same concept.

Shading Coefficient specially addresses only the glass unit of the fenestration excluding the frame. SC is the ratio of radiant heat gain through a given type of glass relative to a 3mm thick clear glass.

Whereas, SHGC includes the effect of the entire fenestration assembly including the frame and the glass.

Exceptions to §4.2.1:

- (a) If the SC value for glass is available, then compliance with this section can be shown by the following calculation.
 $SHGC = SC \times 0.86$
- (b) Rated fenestrations typically include the SHGC of the entire system including the frame and the glass. However, if SHGC of glass alone is available from the manufacturer, then it will be an acceptable alternate for compliance with the SHGC requirements for the overall fenestration product.

4.2.1.3 Visual Light Transmittance

ECBC encourages the use of daylight in buildings.

Visual light transmittance (VLT) shall be determined for the fenestration product in accordance with ISO-15099 by an accredited independent laboratory, and labeled or certified by the manufacturer. For unrated products, use the default table in Appendix A.

Transmittance is a property characteristic of transparent element such as glass. Radiation transmits through such elements and ends up in the space as sensible heat. More about this property is discussed in detail in section

Light to Solar Gain ratio (LSG)

Sunlight brings in both light and heat. Daylight is desirable without the heat gain. Fenestration products should block heat but admit light.

The Light to Solar Gain ration (LSG) shows relationship between SHGC and VLT as follows:

$$LSG = SHGC / VLT$$

GLAZING WITH GREATER LSG ARE MORE SUITABLE FOR DAYLIGHTING IN HOT CLIMATES.

4.2.2 Opaque construction

U-factors shall be calculated for the opaque construction in accordance with ISO-6946. For unrated products, use the default tables in Appendix A.

4.2.3 Daylighting

Since the beginning of construction, daylight has been a big factor in the designs of buildings. Daylight is integral to good building design. Several studies have proven the benefits of daylighting, linking to higher comfort, productivity and feeling of well-being in buildings. An appropriately designed daylighting feature will provide better indoor environmental quality, improve building occupant performance and reduce the building's energy consumption at the same time.

Daylighting can significantly impact the energy use of a building by reducing the lighting energy demand by up to 20-30%. ECBC 2017 mandates the provision of daylighting in buildings. This is a significant update in the Code. The requirement for daylighting will impact building geometry, glass selection, lighting and cooling energy use. This requirement could encourage architects to integrate passive design principles and hence climate appropriate design. Consequently, such a design will reduce the need for lighting and cooling in buildings.

Having good daylighting in a building requires the thought process to be initiated and integrated from the very beginning of the building design

process. Appropriate use of windows, skylights, clerestories, and other apertures in the building are the means to harvest daylight.

Goals of daylighting

The goals of a good daylighting design is to

- Provide sufficient illuminance
- Minimize glare
- Provide overall visual comfort
- Result in improved aesthetics
- Enhance occupant comfort, productivity and health
- Reduce electric lighting energy usage

A well thought out design can easily achieve these goals.

Design strategies for daylighting

There are many design strategies for daylighting in buildings as explained below. These are also fundamental to the concept of solar passive design which means that buildings are designed in response to sun and climate. Such buildings are able to provide comfort using natural resources to a great extent and hence significantly reduce the need for air conditioning.

Building orientation and form

The orientation determines access to sun. Buildings can be located and oriented to take advantage of sun's movement throughout the day, as well as seasonal variations.

- Buildings that are longer on their east-west axis are better for daylighting and visual comfort.
- Larger and taller buildings should have thinner profiles to maximize daylighting potential from side windows.
- Large buildings can get daylight into more spaces by having central courtyards or atria, or having other cut-outs in the building form.

- Focus should be given to maximum daylight factor, increase uniformity of light spread, reduce glare, and minimize solar gains.
- Spaces with high ceilings can accommodate taller windows that help pull daylight further into the space.
- Plan for daylight by minimizing floor plate depth, especially in office buildings

SOUTH FACING SPACES WILL RECEIVE DAYLIGHT THROUGHOUT THE DAY AND MOST OF YEAR. HEAT GAIN CAN BE EFFECTIVELY CONTROLLED ON THE SOUTH FAÇADE.

Fenestrations

Amount of daylight that enters a room depends on the window location and its dimensions.

- Determine the window size, height and glazing treatments for each facade separately.
- Maximize southern exposure and optimize northern exposure.
- North-facing windows provide consistent indirect light with minimal heat gains.
- Minimize eastern and western exposure when the sun is lowest and most likely causes glare and overheating. They are more difficult to shade because the sun is closer to the horizon.
- There is a direct relationship between the height of the window head and the depth of daylight (Typically adequate daylight will penetrate 1.5 times the height of the window head).
- Windows located high in a wall or in roof monitors and clerestories will result in

deeper light penetration and reduces the likelihood of excessive brightness.

- Use skylights and roof monitors to areas without easy access to windows.

Shading devices

Shading devices help bring in daylight without heat. Unlike artificial light fixtures, you can block heat from sunlight and still get light. The size and shape of the shading device is key to block direct solar radiation. Some shading strategies are enumerated below.

- South-facing windows are the easiest to shade. Horizontal shading devices are most effective as they can block summer sun and admit winter sun.
- East- and west-facing windows are best shaded with vertical devices, but these are usually harder to incorporate into a building, and limit views from the window.
- The provision of glare protection devices will reduce the amount of daylight harvested. A balance between glare protection and daylight harvesting needs to be done carefully to ensure that the design of the daylight harvesting system will perform as intended.

BLOCK DIRECT SOLAR RADIATION USING RIGHT SIZE AND FORM OF SHADING DEVICES TO GET LIGHT WITHOUT HEAT

Other strategies

Design strategies can go beyond the building form and windows.

- Use advanced daylight harvesting methods in case of large window area (such as use of external light shelves, light tubes, a higher ceiling height and other similar technologies, would help to distribute the daylight deeper into the building).
- Use of light coloured interior surfaces reduces luminance contrast and improves coverage.

GOOD DAYLIGHTING DESIGN WILL AIM FOR UNIFORMLY DISTRIBUTED LIGHT LEVELS WITHOUT GLARE

BOX 4-1 : Design guidelines for daylighting

1. Buildings that are longer on their east-west axis are better for daylighting and visual comfort
2. Limit the depth of the floor plate to maximize daylit area. Daylight penetration is about 1.5 times the window head
3. taller windows help pull daylight further into the space.
4. Horizontal shading devices are most effective on south facing windows as they can block summer sun and admit winter sun.
5. Minimize windows on the east and west facade when the sun is lowest and most likely causes glare and overheating.
6. Use skylights where side lighting cannot be used for adequate lighting of the deeper areas of the floorplate.
7. North facing skylights are most suitable for work spaces
8. To reduce glare, skylights must be designed with reflective surfaces that redirects direct sunlight into the space.

Key metrics in daylighting

Illuminance: The amount of light falling on a surface is called illuminance.

This is a fundamental metric common to both daylighting and artificial lighting. Standards such as the NBC and ASHRAE 90.1 specify illuminance levels for various space types such as corridors, open office space, classroom and others. Good building design will try to meet the illuminance levels through daylighting. Illuminance can be measured by a lux meter. Units are lumens/sqm.

ECBC mandates that buildings shall achieve illuminance level between 100 lux and 2,000 lux for the minimum percentage of floor area for different building types as per §2.5.

Daylight Factor: Daylight levels keep changing throughout the day and the year since sky conditions are dynamic. Daylight Factor (DF) was

developed to estimate the illuminance inside a space with respect to the exterior illuminance assuming an uniform overcast sky.

Daylight Factor is a ratio of interior illuminance to exterior illuminance.

The National Building Code (NBC) specifies sky illuminance for different climate zones as per Table 4 E.

Table 4 E Illuminance for climate zone

Climate Zone	Illuminance (lux)
Hot and humid	9000
Hot and dry	10500
Composite	8000
Cold and sunny	6800

Daylight Factor is a static metric to measure daylight since it considers overcast sky only. It continues to be used due to its simplicity.

However, Daylight Factor is limiting in terms of not considering the impact of building and window orientation, glazing specification and time of day. The drive towards sustainable and energy efficient buildings has led to the use of metrics that are more realistic and hence help taking important decisions during early design stage. Hence, ECBC has now included the metric - **Useful Daylight Illuminance** which is explained further.

Brightness: Human beings judge brightness of an object relative to the brightness of the surroundings. To a great extent, it depends on the adaptation of the eye. Brightness is a perception of the observer.

For example, car headlamps seem very bright at night but are just noticeable during the day. The brightness we perceive depends on the brightness of the headlamps relative to the overall lighting condition. The levels of brightness can result in useful contrast or discomfort glare as explained below.

Contrast: By definition, contrast is the difference between the brightness of an object and that of its immediate background. Contrast can be extremely helpful in visual task performance. Objects with high contrast are easier to see than objects with low contrast. For example, try to read the text below in Figure 4.17. The text against the lighter background is easier to read than the darker one.

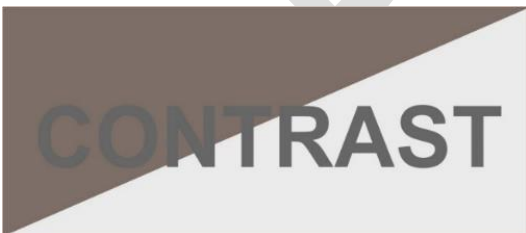

Figure 4.17 Contrast

High contrast is the critical factor in visual appreciation of details such as outline,

silhouette, and size, etc which are the factors involved in tasks such as reading, writing.

Glare: Excessive contrast will reduce the visibility. This results in glare. An extremely bright object against a dark background causes discomfort and can interfere with our visual perception.

Direct glare is caused by a light source sufficiently bright to cause discomfort or loss in visibility. For example, in Figure 4.18, the bright sun shining right onto the street reduces direct visibility in the immediate surroundings.



Figure 4.18 Direct glare

Indirect glare is caused by reflections of light sources on glossy surfaces. An example is shown in Figure 4.19.



Figure 4.19 Indirect glare

Usually, buildings having very large glazed areas tend to have the problem of glare inside the space. Further, light reflected off the glass façade can result in glare on neighboring buildings and objects. Overall, glare is commonly associated with discomfort and hence undesirable.

Glare can be controlled by using external shading devices on fenestrations and/or by using interior blinds.

Useful Daylight Illuminance

Daylighting design does not mean abundance of light filling up a space, but it is a careful balance of light and heat. It is important to have useful daylight which is what the term 'Useful Daylight Illuminance'(UDI) refers to.

UDI is defined as the annual occurrence of illuminances across the work plane that are within a range considered "useful" by occupants (Nabil and Mardaljevic 2005). UDI is an attempt to integrate glare and daylight levels in one scheme.

The UDI considers the range between 100 lux and 2,000 lux on the workplane as 'useful daylight'. Above this threshold, daylight is not desired due to potential glare or overheating. Daylight levels below this range is considered inadequate for tasks. The workplane is considered as the horizontal plane at a height of 30 inches or 760mm. It is a common practice to assess illumination levels at the workplane level since most activities are considered to take place at this height.

There is limited research in support of considering 2,000 lux as an absolute upper threshold. However, UDI is a widely used metric in the industry and is considered more realistic in predicting daylight levels in space.

As per the Code,

Above grade floor areas shall meet or exceed the useful daylight illuminance (UDI) area requirements listed in Table 4-1 for 90% of the potential daylit time in a year. Mixed-use buildings shall show compliance as per the criteria prescribed in §2.5. Compliance shall be demonstrated either through daylighting simulation method in §4.2.3.1 or the manual method in §4.2.3.2. Assembly buildings and other buildings where daylighting will interfere with the functions or processes of 50% (or more) of the building floor area, are exempted from meeting the requirements listed in Table 4-1.

A building should meet the following UDI parameters for ECBC compliance.

- 1) Meet the illuminance range of 100 – 2000 lux
- 2) Meeting UDI levels ranging from 10% to 40% of the gross floor area as per Table 4-1. The floor area requirement changes as per the building type and the targeted performance level.
- 3) UDI levels should meet 90% of the potential daylit time in a year. This means that the space/room receives useful daylight for 90% of the time.

Potential daylit time is considered as 8 hours per day anytime between 8am and 5pm for all building types except for schools which will be for 7 hours anytime between 7am and 3pm.

Table 4-1 Daylight Requirement

Building Category	Percentage of above grade floor area meeting the UDI requirement		
	ECBC	ECBC+	SuperECBC
Business, Educational	40%	50%	60%
No Star Hotel Star Hotel Healthcare	30%	40%	50%
Resort	45%	55%	65%
Shopping Complex	10%	15%	20%
Assembly*	Exempted		
*and other buildings where daylighting will interfere with the functions or processes of 50% (or more) of the building floor area			

Daylight compliance

Compliance shall be demonstrated by either of the following two methods.

- 1) Simulation Method (§4.2.3.1)
- 2) Manual calculation method (§4.2.3.2)

4.2.3.1 Daylighting Simulation Method

Computer simulations help create a virtual model of the space for which daylight levels is to be predicted. One of the major benefits of using simulations is the ability to model the buildings and its surroundings exactly the way it is and hence get a realistic estimate of the daylight levels in the design. It is also helpful for the assessment of complex designs. Although executing simulations requires a specialized skill set, such analytical tools and design methods are growing in the industry.

Only BEE approved software shall be used to demonstrate compliance through the daylighting simulation method. A list of approved software for daylighting analysis from Appendix E: BEE approved list of software to show compliance is reproduced here for convenience.

The simulation method can be adopted for compliance towards §4.2.3 even if the project

has chosen the prescriptive approach for Code compliance.

Analysis	Software
Daylighting	AGI32 (Licaso) Daysim Design Builder DIVA Groundhog IES-VE OpenStudio Radiance-Rhino-Grasshopper with Daylighting Plugins Sefaira Sensor Placement + Optimization Tool (SPOT)

The following points are to be incorporated while executing daylight simulations. As per the Code,

Illuminance levels for all spaces enclosed by permanent internal partitions (opaque, translucent, or transparent) with height greater or equal to 2m from the finished floor, shall be measured as follows:

- (a) Measurements shall be taken at a work plane height of 0.8 m above the finished floor.
- (b) The period of analysis shall be fixed for 8 hours per day, anytime between 8:00 AM IST to 5:00 PM IST, resulting in 2920 hours in

total for all building types except for schools. Schools shall be analyzed for 7 hours per day, anytime between 7:00 AM IST to 3:00 PM IST.

- (c) Available useful daylight across a space shall be measured based on point-by-point grid values. UDI shall be calculated for at least one point for each square meter of floor area.
- (d) Fenestration shall be modelled with actual visible light transmission (VLT) as per the details provided in the material specification sheet.
- (e) All surrounding natural or man-made daylight obstructions shall be modeled if the distance between the façade of the building (for which compliance is shown) and surrounding natural or man-made daylight obstructions is less than or equal to twice the height of the man-made or natural sunlight obstructers. Refer Figure 4.20.

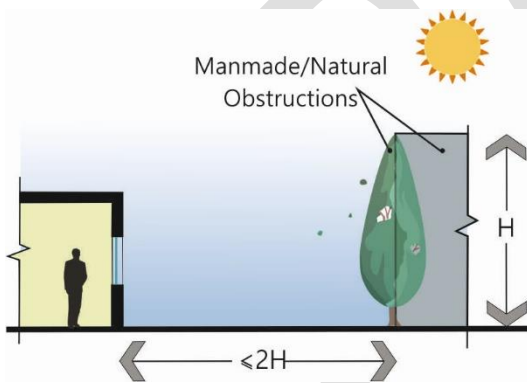

Figure 4.20 Modeling surrounding obstructions

If the reflectance of the surfaces is not known, default reflectance of 30% and 0% shall be used for all vertical surfaces of man-made and natural obstructers respectively.

- (f) Interior surface reflectance shall be modeled based on the actual material specification. If material specification is not available, following default values shall be used:

Table 4-2 Default Values for Surface Reflectance

Surface Type	Reflectance
Wall or Vertical Internal Surfaces	50%
Ceiling	70%
Floor	20%
Furniture (permanent)	50%

Buildings shall achieve illuminance level between 100 lux and 2,000 lux for the minimum percentage of floor area prescribed in Table 4-1 for at least 90% of the potential daylit time.

4.2.3.2 Manual Daylighting Compliance Method

This method can be used to show compliance through calculations without using computer software. Manual calculation is an easier approach compared to using simulations. However, it can be limiting in assessing the full potential of a building design. Generally, the manual method is suitable for projects adopting the prescriptive compliance approach.

As per the Code,

Daylight extent factors (DEF) mentioned in Table 4-3 shall be used for manually calculating percentage of above grade floor area meeting the UDI requirement for 90% of the potential daylit time in a year.

The DEF accounts for orientation and glazing VLT of the fenestration, shading devices adjacent to it and building location. Thus, the building design parameters are taken into account in the manual method.

Steps for manual calculations are given below:

1. Determine the projection factor for every fenestration that has a shading device as per the following.

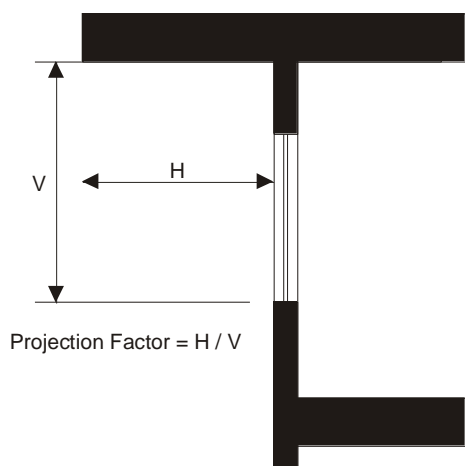

Figure 4.21 Projection Factor calculation

Projection factor, overhang: the ratio of the horizontal depth of the external shading projection to the sum of the height of the fenestration and the distance from the top

of the fenestration to the bottom of the farthest point of the external shading projection, in consistent units (Figure 4.21).

Projection factor, side fin: the ratio of the horizontal depth of the external shading projection to the distance from the window jamb to the farthest point of the external shading projection, in consistent units.

Projection Factor, overhang and side fin: average of ratio projection factor for overhang only and projection factor of side fin only.

2. Table 4-3 Determine the Daylight Extent Factor (DEF) from Table 4-3 for each fenestration as per the orientation and corresponding VLT.

Table 4-3 Daylight Extent Factors (DEF) for Manually Calculating Daylight Area

Shading	Latitude	Window Type	VLT < 0.3				VLT ≥ 0.3			
			North	South	East	West	North	South	East	West
No shading or PF < 0.4	≥ 15°N	All window types	2.5	2.0	0.7	0.5	2.8	2.2	1.1	0.7
	< 15°N		2.4	2.0	1.3	0.6	2.7	2.2	1.5	0.8
Shading with PF ≥ 0.4	All latitudes	All window types without light shelf	2.8	2.3	1.5	1.1	3.0	2.5	1.8	1.5
		Window with light shelf	3.0	2.5	1.8	1.6	3.5	3.0	2.1	1.8

3. Calculate the daylit area contributed by each fenestration as per the following

Vertical Fenestrations

1. In a direction perpendicular to the fenestration, multiply daylight extent factor (DEF) by the head height of the fenestration or till an opaque partition (with height greater or equal to 2m from the finished floor), whichever is less.

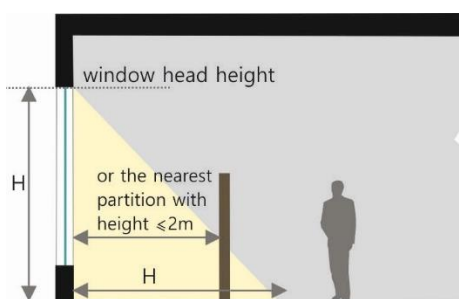

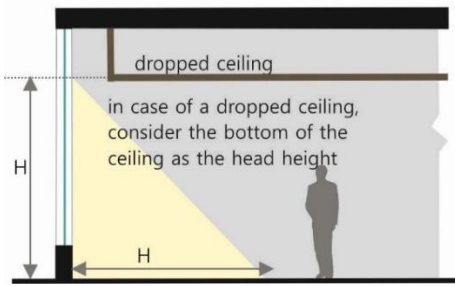

Daylit area (distance perpendicular to fenestration) = $DEF * H$

Figure 4.22 Daylit area calculation for vertical fenestration (section)

- II. In the direction parallel to the fenestration, daylit area extends a horizontal dimension equal to the width of the fenestration plus either 1 meter on each side of the aperture, or the distance to an opaque partition of 2m high, or one-half the distance to an adjacent fenestration, whichever is least.

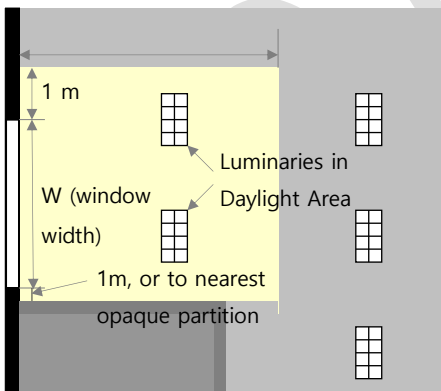

Daylit area (distance parallel to fenestration) = $W + 2m$

Figure 4.23 Daylight area calculation for vertical fenestration (plan)

Skylights

- III. For skylights, calculate the horizontal dimension in each direction equal to the top aperture dimension in that direction plus either the floor-to-ceiling height (H) for skylights, or 1.5 H for monitors, or H or

2H for the sawtooth configuration, or the distance to the nearest 1 meter or higher opaque partition, or one-half the distance to an adjacent skylight or vertical glazing, whichever is least.

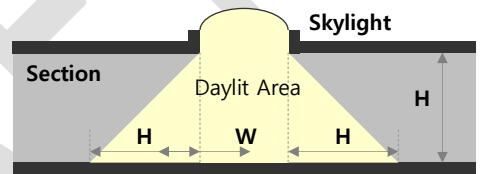
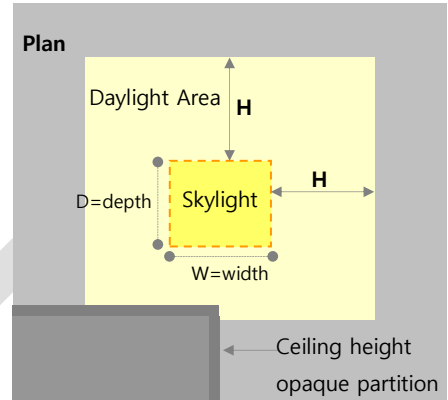

Daylit area for skylight = $W + (H * 2)$

Figure 4.24 Daylit area calculation for skylight

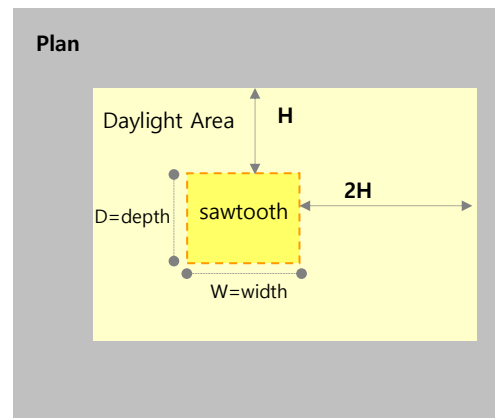

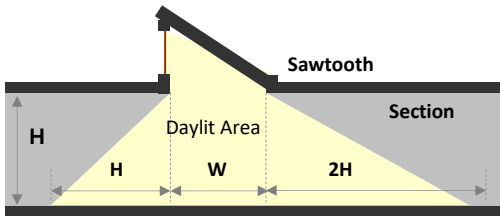

Daylit area for sawtooth = $H + W + 2H$

Figure 4.25 Daylit area calculation for sawtooth

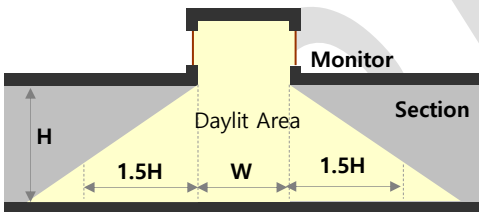
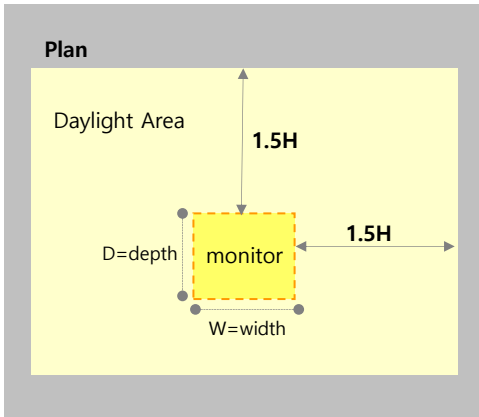

Daylit area for monitor = $W + (1.5H \times 2)$

Figure 4.26 Daylit area calculation for monitor

4. A summation of all the individual daylight areas should be done showing compliance as per Table 4-1.
5. An architectural plan shall be prepared with all daylit areas marked on the floor plans.
6. Glazed facades and fenestrations with non-cardinal orientation, shall be categorized under a particular cardinal direction if the orientation is within ± 45 degrees of that cardinal direction.
7. Any surrounding natural or man-made daylight obstructions shall not be considered in this method.
8. Daylit area overlap: For overlapping daylit areas such as windows on different orientations or in case of skylights the overlapping daylit area shall be subtracted from the sum of daylit area.

Documentation of the calculations:

- i. A separate architectural plan shall be prepared with all daylit areas marked on the floor plans.
- ii. A summary shall be provided showing compliance as per Table 4-1.

Example 4-C

An office building in Delhi is trying to achieve ECBC level compliance. Building is oriented along east west axis. The typical floor has a rectangular layout (33 m x 38 m) or 1,254 m². VLT of glazing in all orientations is 0.39. Windows have light shelves and external shading devices with PF ≥ 0.4. Head height of fenestrations is 3.0 m. Length of glazing on the north and south facing façade is 45 meter and on the east façade, 25 meter. Determine if this building is compliant with ECBC.

Answer:

As per compliance requirements listed in Table 4-1 the project should have a minimum of 40% of its floor area exposed to daylight in range of 100 – 2,000 lux for at least 90% of the year.

Thus, this project must have at least 502m² (40% of 1,254 m²) of floor area fulfilling the UDI requirements. Compliance with § 4.2.3 Daylight Requirements can be checked for through two approaches.

- 1) Simulation method
- 2) Manual calculation method

Simulation method

The image below, developed through an BEE approved software (§ 3.4), specifies the lux levels and time period of a year during which lighting levels would be available. With this information, designers can check if the required minimum area as per § 4.2.3 has the required daylight levels.

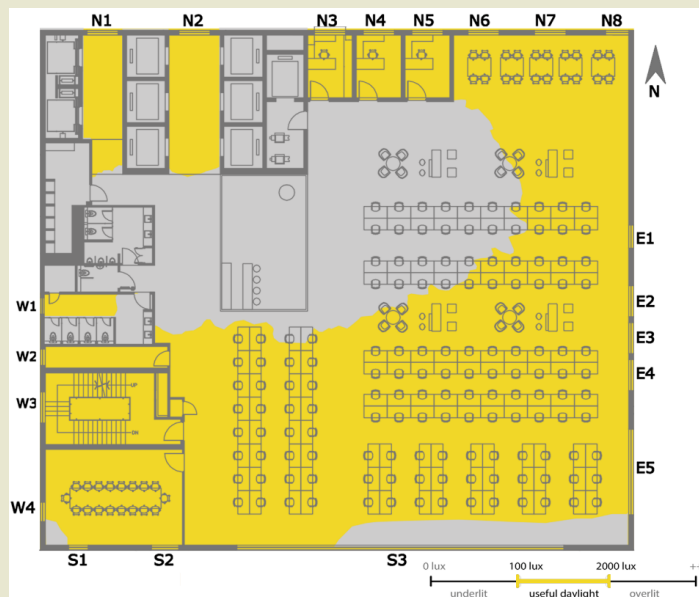

UDI Analysis with a Daylighting Analysis Software

Manual calculation method

Step 1: Since the projection factor and VLT are already given, list the DEF from

Table 4-3 for each orientation. Thus,

DEF for windows in North = 3.5

DEF for windows in South = 3.0

DEF for windows in East = 2.1

DEF for windows in West = 1.8

Step 2 : Calculate the daylit area for each fenestration. There are only vertical fenestrations in this building. Head height is 3.0 m.

Thus, for direction perpendicular to the fenestration, daylit area = DEF * 3m

Thus, for direction parallel to the fenestration, daylit area = Window width + 2m

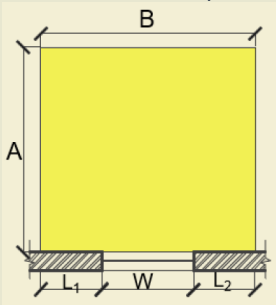

For overlapping daylit areas such as corner windows. Subtract the overlapping daylit area from the sum of daylit area.

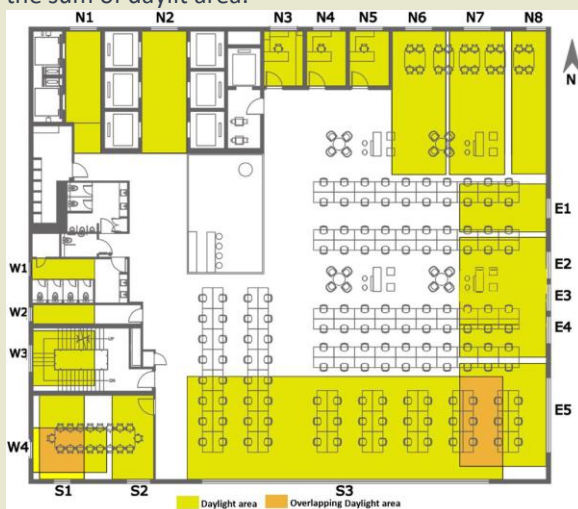

UDI analysis with manual calculations

The calculation for each fenestration can be tabulated as follows. As per the calculations 616.5 m² of floor area will meet the UDI requirements during 90% of the year. This is 49.2 % of the total above grade floor area of 1,254 m². Thus, the building floor will comply with UDI requirement. Following Tables shows calculated Daylight Area Meeting UDI Requirement.

Table 4-1-1 Manual calculation for Daylight Area Meeting UDI Requirement

Orientation-NORTH, DEF-3.5, Fenestration Head Height H - 3m				
<i>Window without opaque obstructions</i>	<i>Fenestration Width W (m)</i>	<i>A= H x DEF (m)</i>	<i>B= L₁+W+ L₂ (m) L₁= L₂=1m</i>	<i>Area meeting the UDI requirements = Ax B (m²)</i>
N7	2.0	10.5	4.0	42.0
N6	2.0	10.5	4.0	42.0
N2	2.0	10.5	4.0	42.0
<i>Window with opaque obstructions</i>	<i>Fenestration Width W (m)</i>	<i>A= Distance till parallel Obstruction (m)</i>	<i>B= L₁+W+ L₂ (m) L₁= L₂=Distance to perpendicular Obstructions</i>	<i>Area meeting the UDI requirements = Ax B (m²)</i>
N1	2.0	10.5	0.3+2+0.3=2.6	27.3
N3	2.0	4.0	0.4+2+0.4=2.8	11.2
N4	2.0	4.0	0.4+2+0.4=2.8	11.2
N5	2.0	4.0	0.4+2+0.4=2.8	11.2
N8	1.5	10.5	0+1.5+1.0=2.5	26.3
<i>Daylit area meeting UDI requirement</i>				213.2

Orientation-SOUTH, DEF-3, Fenestration Head Height H - 3m

<i>Window without opaque obstructions</i>	<i>Fenestration Width W (m)</i>	<i>A= H x DEF (m)</i>	<i>B= L₁+W+ L₂ (m) L₁= L₂=1m</i>	<i>Area meeting the UDI requirements = Ax B (m²)</i>
S1	1.2	6.2	1.0+1.2+1.0=3.3	20.1
S2	1.7	6.2	1.0+1.7+0.3=3.0	18.6
S3	21.0	9.0	1.0+21.0+1.0=24	216.0
<i>Daylit area meeting UDI requirement</i>				254.7

Orientation-EAST, DEF-2.1, Fenestration Head Height H - 3m

Window without opaque obstructions	Fenestration Width W (m)	A= H x DEF (m)	B= L ₁ +W+ L ₂ (m) L ₁ = L ₂ =1m	Area meeting the UDI requirements = AxB (m ²)
E1	1.5	6.3	1.0+1.5+1.0=3.5	22.1
E5	5.5	6.3	1.0+5.5+1.0=7.5	47.3
Adjacent fenestration less than two meter apart	Fenestration Width W (m)	A= H x DEF (m)	B= L ₁ +W+ L ₂ (m) L ₁ , L ₂ =one half of distance to adjacent fenestration	Area meeting the UDI requirements = AxB (m ²)
E2	2	6.3	1.0+2.0+0.2=3.2	20.2
E3	2	6.3	0.2+2+0.2=2.4	15.1
E4	2	6.3	0.2+2+1=3.2	20.2
Daylit area meeting UDI requirement				124.9

Orientation-WEST, DEF-1.8, Fenestration Head Height H - 3m

Window without opaque obstructions	Fenestration Width W (m)	A= H x DEF (m)	B= L ₁ +W+ L ₂ (m) L ₁ = L ₂ =1m	Area meeting the UDI requirements = AxB (m ²)
W3	2.0	5.4	1.0+2.0+1.0=4.0	21.6
W4	1.4	5.4	1.0+1.2+1.0=3.2	17.3
Window with opaque obstructions in daylit area	Fenestration Width W (m)	A= H x DEF (m)	B= L ₁ +W+ L ₂ (m) L ₁ = L ₂ =Distance to perpendicular Obstructions	Area meeting the UDI requirements = AxB (m ²)
W1	1.0	5.4	0.3+1+0.3=1.6	8.6
W2	1.0	5.4	0.3+1+0.3=1.6	8.6
Daylit area meeting UDI requirement				56.1

Overlapping area calculations

Window with overlap areas	Width (m)	Depth (m)	Area (m ²)
N4 and S1	3.3	3.3	10.9
S3 and E5	3.3	6.5	21.5
Overlapping daylight area (b)			32.4

<i>Total Daylit area</i>	
<i>ORIENTATION</i>	<i>Daylit area (m²)</i>
<i>NORTH</i>	<i>213.2</i>
<i>SOUTH</i>	<i>254.7</i>
<i>EAST</i>	<i>124.9</i>
<i>WEST</i>	<i>56.1</i>
<i>Total daylight area (a)</i>	<i>648.9</i>
<i>Total Overlapping daylit area (b)</i>	<i>32.4</i>
<i>Total daylit area meeting UDI requirement during 90% of the year (a-b)</i>	<i>616.5</i>

Daylight area should be indicated in floor plans submitted to code enforcement authorities.

Note:

Design guidelines on daylighting stated in NBC (Part 8: Building Services, Section 1: Lighting and Natural Ventilation, Subsection 4.2: Daylighting) should also be referred to achieve the ECBC, ECBC+, or SuperECBC requirement.

4.2.4 Building Envelope Sealing

Uncontrolled entry of air through the building envelope is called infiltration or air leakage. In air conditioned buildings, when warm air from outside enters the interiors, it adds sensible heat to the conditioned space. If the outside air is moist, it also adds latent heat. The air conditioning system has to work more to remove this additional heat which increases energy consumption. Hence energy efficient buildings should prevent infiltration.

Further, infiltration can cause condensation to form within and on walls. This can create many problems including reducing insulation R-value, permanently damaging insulation, and seriously degrading materials.

It can rot wood, corrode metals, stain brick or concrete surfaces, and in extreme cases cause concrete to break, bricks to separate, mortar to crumble and sections of a wall to fall jeopardizing the safety of occupants. It can corrode structural steel, re-bar, and metal hangers and bolts with very serious safety and maintenance consequences. Moisture accumulation in building materials can lead to the formation of mold that may require extensive remedying the situation.

Virtually anywhere in the building envelope where there is a joint, junction or opening, there is potential for infiltration. This will cause the HVAC system to run more often and longer at one time, and still leave the building uncomfortable for its occupants.

A tightly constructed building envelope is largely achieved through careful construction practices and attention to detail. All openings in the building envelope, including joints and other openings that are potential sources of air leakage, should be sealed to minimize air leakage. It means that all gaps between wall panels, around doors, and other construction joints must be well sealed. Ceiling joints, lighting fixtures, plumbing openings, doors, and windows should all be considered as potential sources of unnecessary energy loss due to air infiltration.

It must be noted that building sealing is more important in air-conditioned buildings. In naturally ventilated buildings, the concept of building ceiling and tight envelope runs counter to conventional and traditional wisdom.

ECBC identifies several areas in the building envelope where attention should be paid to infiltration control. These include:

- a) Joints around fenestration, skylights, and door frames
- b) Openings between walls and foundations, and between walls and roof, and wall panels
- c) Openings at penetrations of utility services through roofs, walls, and floors
- d) Site-built fenestration and doors

- e) Building assemblies used as ducts or plenums
- f) All other openings in the building envelope
- g) Exhaust fans shall be fitted with a sealing device such as a self-closing damper
- h) Operable fenestration should be constructed to eliminate air leakages from fenestration frame and shutter frame.

4.3 Prescriptive Requirements

All envelope components can comply with the prescriptive requirements as described in this section.

4.3.1 Roof

The intensity of solar radiation is highest on a horizontal surface such as roof. Atleast 80% of the day time heat gain is through the roof. Hence, heat gain through roof is significant. Improving thermal performance of the roof helps reducing the cooling loads of the building.

As per the Code,

Roofs shall comply with the maximum assembly U-factors in Table 4-4 through Table 4-6. The roof insulation shall be applied externally as part of structural slab and not as a part of false ceiling.

Table 4-4 Roof Assembly U-factor (W/m².K) Requirements for ECBC Compliant Building

	Composite	Hot and dry	Warm and humid	Temperate	Cold
All building types, except below	0.33	0.33	0.33	0.33	0.28
School <10,000 m ² AGA	0.47	0.47	0.47	0.47	0.33
Hospitality > 10,000 m ² AGA	0.20	0.20	0.20	0.20	0.20

Table 4-5 Roof Assembly U-factor (W/m².K) Requirements for ECBC+ Compliant Building

	Composite	Hot and dry	Warm and humid	Temperate	Cold
Hospitality, Healthcare Assembly	0.20	0.20	0.20	0.20	0.20
Business Educational Shopping Complex	0.26	0.26	0.26	0.26	0.20

Table 4-6 Roof Assembly U-factor (W/m².K) Requirements for SuperECBC Building

	Composite	Hot and dry	Warm and humid	Temperate	Cold
All buildings types	0.20	0.20	0.20	0.20	0.20

Insulation

Insulation materials help reduce heat gain substantially. It is recommended that insulation materials be installed according to the manufacturer’s recommendations and in a manner that will achieve the rated insulation R-value. Compressing the insulation reduces the effective R-value and the thermal performance of the construction assembly. Insulation gives the maximum benefit when installed correctly in the right position.

Substantial Contact

It is recommended that insulation be installed in a permanent manner and in substantial contact with the inside surface of the construction assembly. If the insulation does not entirely fill the cavity, the air gap should be on the outside surface. Maintaining substantial contact is particularly important (and problematic) for batt insulation installed between floor joists. Without proper support, gravity will cause the insulation to fall away from the floor surface, leaving an air gap above the insulation. Air currents will ultimately find their way to the gap, and when they do, the effectiveness of the insulation will be substantially reduced.

Insulation Above Suspended Ceilings

It is not good practice to install insulation directly over suspended ceilings with removable ceiling panels. This is because the insulation’s continuity is likely to be disturbed by maintenance workers. Also, suspended ceilings may not meet the ECBC’s infiltration requirements unless they are properly sealed. Compliance with this requirement could have a significant impact in some parts of the country, as it is common practice to install insulation over suspended ceilings.

Insulation Protection

It is strongly recommended that insulation be protected from sunlight, moisture, landscaping equipment, wind, and other physical damage. Rigid insulation used at the slab perimeter of the building should be covered to prevent damage from gardening or landscaping equipment. Rigid insulation used on the exterior of walls and roofs should be protected by a permanent waterproof membrane or exterior finish. In general, a prudent designer should pay attention to moisture migration in all building construction. Vapor retarders prevent moisture from

condensing within walls, roofs, or floors but care should be taken to install them on the correct side (warmer or cooler side) of the walls and roofs to prevent water damage. Water condensation can damage the building structure and can seriously degrade the performance of building insulation and create many other problems such as mold and mildew. The designer should evaluate the thermal and moisture conditions that might contribute to condensation and make sure that vapor retarders are correctly installed to prevent condensation. In addition to correctly installing a vapor retarder, it is important to provide adequate ventilation of spaces where moisture can build up. Figure 4.27 shows some techniques for roof insulation.

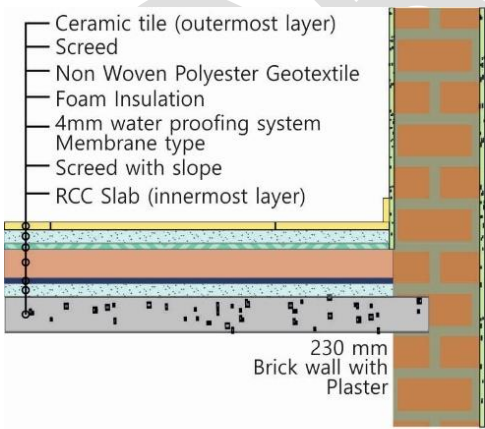
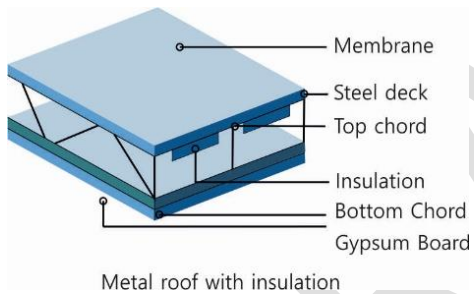

RCC slab with insulation

Figure 4.27 Roof insulation techniques

4.3.1.1 Vegetated and Cool Roof

In addition to shading and providing insulation, selecting the right roof finish can have a noticeable impact on heat gain through the roof.

Cool Roof

Cool roofs reflect most of the solar radiation and efficiently emit some of the absorbed radiation back into the atmosphere, instead of conducting it to the building below. Thus, cool roof reduces the need for air conditioning and make buildings more comfortable to the occupants.

The property of the outer layer of the roof shall determine the performance of the cool roof. Due to the high reflectance, cool roofs result in cooler air temperatures for the surrounding urban environment during hot summer months.

Cool roofs have other benefits as well. For building owners, they can cut maintenance costs and increase the life expectancy of the roof. For society in general, cool roofs can even help to reduce the urban heat island effect and slow down global warming that makes our cities hotter and produces unhealthy air.

Solar Reflectance Index (SRI)

Solar Reflectance Index or the SRI is the metric used to measure the performance of a cool roof. SRI is a measure of the ability of the constructed surface to reflect solar heat, as shown by a small temperature rise. SRI, which incorporates both solar reflectance and emittance in a single value, quantifies how hot a surface would get relative to standard black and standard white surfaces. Higher the SRI, better the material in reflecting heat.

SELECT MATERIALS WITH HIGH SRI FOR A COOL ROOF APPLICATION

(Refer to *Material property that affect radiation* for an overview of fundamentals)

SRI is defined so that a standard black (reflectance 0.05, emittance 0.90) is 0, and a standard white (reflectance 0.80, emittance 0.90) is 100. For example, the standard black has a temperature rise of 50°C in full sun, and the standard white has a temperature rise of 8.1°C. Once the maximum temperature rise of a given material has been computed, the SRI can be computed by interpolating between the values for white and black. Table 4 F list SRI for typical roofing materials.

Cool roof materials

Products for low-slope roofs, found on commercial and industrial buildings fall into two categories: single-ply materials and coatings. Single-ply materials are large sheets of pre-made roofing that are mechanically fastened over the existing roof and sealed at the seams. Coatings are applied using rollers, sprays or brushes over an existing clean, leak-free roof surface. Products for sloped roofs are currently available in clay, or concrete tiles. These products stay cooler by the use of special pigments that reflect the sun's infrared heat. In India, lime coats, white tiles grouted with white cements, special paint, etc. are used as cool roofing materials.

As per ECBC - All roofs that are not covered by solar photovoltaics, or solar hot water, or any other renewable energy system, or utilities and services that render it unsuitable for the purpose, shall be either cool roof or vegetated roof.

(a) For qualifying as a cool roof, roofs with slopes less than 20° shall have an initial solar reflectance of no less than 0.60 and an initial emittance no less than 0.90. Solar reflectance shall be determined in accordance with ASTM E903-96 and emittance shall be determined in accordance with ASTM E408-71 (RA 1996).

(b) For qualifying as a vegetated roof, roof areas shall be covered by living vegetation of >50mm high.

Table 4 F SRI for typical roofing materials

Example SRI Values for Generic Roof Materials	SR	IE	Temp Rise (C Deg)	SRI
Gray EPDM	0.23	0.87	38	21
Gray Asphalt Shingle	0.22	0.91	37	22
Unpainted Cement Tile	0.25	0.9	36	25
White Granular Surface Bitumen	0.26	0.92	35	28
Red Clay Tiles	0.33	0.9	32	36
Light Gravel on Built-up Roofing	0.34	0.9	32	37
Aluminium	0.61	0.25	27	56
White Coated Gravel on Built-up Roofing	0.65	0.9	16	79
White Coated on Metal Roof	0.67	0.85	16	82
White EPDM	0.69	0.87	14	84
White Cement Tiles	0.73	0.9	12	90
White Coating-1 coat-8 mils	0.8	0.91	8	100
PVC White	0.83	0.92	6	104
White Coating-1 coat-20 mils	0.85	0.91	5	107

SR = Solar Reflectance

IE = Infrared Emissivity

Vegetated roof

Vegetated roof or green roof or a living roof is a building roof that has growing vegetation on it. Potted plants on the roof are generally not considered as a green roof. The vegetated roof system consists of soil, plants, drainage layer and irrigation system (Figure 4.28).

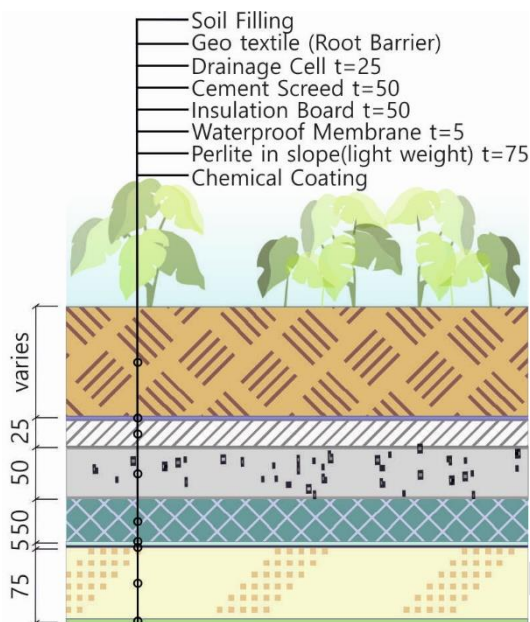

Figure 4.28 Detailed section of a vegetated roof

The soil being moist adds thermal mass to the roof structure and hence slows down the heat gain significantly. While the plants do not reflect heat like a cool roof paint, it does help create a relatively cooler microclimate through evapotranspiration. This further helps in mitigating the urban heat island effect. A green roof provides an added benefit of reducing storm water run-off from the roof.

4.3.2 Opaque External Wall

Opaque above grade walls can meet the prescriptive requirements by using a construction that has an assembly U-factor lower than the specified value as shown in ECBC

Table 4-7 through Table 4-9 for each climate type.

Table 4-7 Opaque Assembly Maximum U-factor ($W/m^2.K$) Requirements for a ECBC compliant Building

	Composite	Hot and dry	Warm and humid	Temperate	Cold
All building types, except below	0.40	0.40	0.40	0.55	0.34
No Star Hotel < 10,000 m ² AGA	0.63	0.63	0.63	0.63	0.40
Business < 10,000 m ² AGA	0.63	0.63	0.63	0.63	0.40
School <10,000 m ² AGA	0.85	0.85	0.85	1.00	0.40

Table 4-8 Opaque Assembly Maximum U-factor ($W/m^2.K$) Requirements for ECBC+ Compliant Building

	Composite	Hot and dry	Warm and humid	Temperate	Cold
All building types, except below	0.34	0.34	0.34	0.55	0.22
No Star Hotel < 10,000 m ² AGA	0.44	0.44	0.44	0.44	0.34
Business < 10,000 m ² AGA	0.44	0.44	0.44	0.55	0.34
School <10,000 m ² AGA	0.63	0.63	0.63	0.75	0.44

Table 4-9 Opaque Assembly Maximum U-factor ($W/m^2.K$) Requirements for SuperECBC Building

	Composite	Hot and dry	Warm and humid	Temperate	Cold
All building types	0.22	0.22	0.22	0.22	0.22

Exemptions to §4.3.2: Opaque external walls of an unconditioned building of No Star Hotel, Healthcare, and School categories in all climatic zones, except for cold climatic zone, shall have maximum assembly U-factor of 0.8 $W/m^2.K$

4.3.3 Vertical Fenestration

Heat gain through fenestrations depends on the area of glazing, frame material and the specification of the glazing (U-factor, SHGC and VLT). Window Wall Ratio (WWR) denotes the area of window as a percentage of the wall area. That means, ratio of area of glass to the area of wall. Larger WWR will mean more heat gain due to solar radiation. Unshaded fenestrations add fuel to the fire by allowing direct radiation into the space thereby increasing the need for cooling.

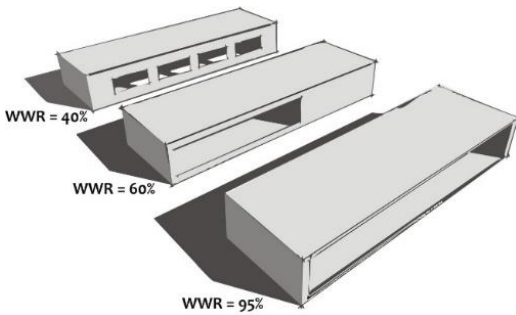

Facades with different window-wall ratios

Figure 4.29 Window Wall Ratio

The ECBC has the following requirements.

- (a) Maximum allowable Window Wall Ratio (WWR) is 40% (applicable to buildings showing compliance using Prescriptive Method, including Building Envelope Trade-off Method)

If the WWR is greater than 40%, then Whole Building Performance Method can be used to show compliance.

- (b) Minimum allowable Visual Light Transmittance (VLT) is 0.27
- (c) Assembly U-factor shall be determined for the overall fenestration product (including the sash and frame)

Vertical fenestration shall comply with the maximum Solar Heat Gain Coefficient (SHGC) and U-factor requirements of Table 4-10. Vertical fenestration on non-cardinal direction shall be categorized under a particular cardinal direction if its orientation is within $\pm 45^\circ$ of that cardinal direction.

Table 4-10 Vertical Fenestration Assembly U-factor and SHGC Requirements for ECBC Buildings

	Composite	Hot and dry	Warm and humid	Temperate	Cold
Maximum U-factor ($W/m^2.K$)	3.00	3.00	3.00	3.00	3.00
Maximum SHGC Non-North	0.27	0.27	0.27	0.27	0.62
Maximum SHGC North for latitude $\geq 15^\circ N$	0.50	0.50	0.50	0.50	0.62
Maximum SHGC North for latitude $< 15^\circ N$	0.27	0.27	0.27	0.27	0.62

See Appendix A for default values of unrated fenestration.

Table 4-11 Vertical Fenestration U-factor and SHGC Requirements for ECBC+ buildings and SuperECBC buildings

	Composite	Hot and dry	Warm and humid	Temperate	Cold
Maximum U-factor (W/m ² .K)	2.20	2.20	2.20	3.00	1.80
Maximum SHGC Non-North	0.25	0.25	0.25	0.25	0.62
Maximum SHGC North for latitude ≥ 15°N	0.50	0.50	0.50	0.50	0.62
Maximum SHGC North for latitude < 15°N	0.25	0.25	0.25	0.25	0.62

Fundamentally, the U-value of an opaque assembly will always be significantly lower than glazing; even the best one. Moreover, the maximum U-value for opaque wall for Code compliance is 0.4 W/m².K whereas for fenestration it is 3 W/m².K. It is clearly evident that reducing the fenestration area in buildings is key to reduce cooling energy requirement and hence better energy efficiency.

Secondly, reducing direct solar radiation through fenestrations is crucial to avoid unwanted heat gains in a hot climate. This can be done by providing external shading devices or by selecting a glass with a low SHGC. Selective coatings on the glass help achieve low SHGC ratings. However, this typically reduces the VLT as well. Thus, while reducing solar radiation, the daylight levels are also compromised.

SHGC OF 0.27 MEANS 73% OF THE INCOMING SOLAR RADIATION IS BLOCKED BY THE GLASS. THIS COULD ALSO MEAN REDUCING THE VLT TO 50% OR LESS. WHEREAS AN ADEQUATELY DESIGNED EXTERNAL SHADING DEVICE WILL ALWAYS BLOCK 100% OF THE SOLAR RADIATION WHILE ALLOWING 85-90% OF DAYLIGHT THROUGH A CLEAR GLASS.

Exceptions to SHGC requirements

The Code allows an exception to the SHGC requirements in Table 4-10 if shading devices are provided for fenestrations.

For fenestration with a permanent external projection, including but not limited to overhangs, side fins, box frame, verandah, balcony, and fixed canopies that provide permanent shading to the fenestration, the equivalent SHGC for the proposed shaded fenestration may be determined as less than or equal to the SHGC requirements of Table 4-10.

Steps to calculate Equivalent SHGC

- 1) Projection factor (PF) for the external permanent projection, shall be calculated as per the applicable shading type listed in §8.2. The projection factor for using the SEF is **PF ≥ 0.25**.
 - a. Every fenestration will have only one PF
 - b. If a fenestration has fins on both sides, then the PF for each fin shall be calculated and the lower PF value shall be considered.
 - c. If a fenestration has both fins and overhangs, then calculate the PF for both and take an average.
 - d. Other shading devices shall be modelled through the Whole Building Performance Method in §9.

- 2) Determine Equivalent SHGC as per the following:
EQUIVALENT SHGC = SHGC OF UNSHADED FENESTRATION / SEF
- 3) Calculate the maximum allowable SHGC as per the following
MAXIMUM ALLOWABLE SHGC = SEF * PRESCRIPTIVE SHGC FROM TABLE 4-10

Table 4-12 Coefficients of Shading Equivalent Factors for Latitudes greater than or equal to 15°N

Shading Equivalent Factors (SEF) for latitudes greater than or equal to 15°N									
SEF	PF	North	East	South	West	North-East	South-East	South-West	North-West
Overhang + Fins	0.25	1.25	1.37	1.58	1.36	1.47	1.47	1.42	1.53
	0.3	1.29	1.48	1.72	1.43	1.54	1.65	1.57	1.58
	0.35	1.34	1.58	1.88	1.51	1.62	1.81	1.73	1.65
	0.4	1.39	1.67	2.06	1.61	1.70	1.97	1.89	1.75
	0.45	1.43	1.76	2.26	1.71	1.78	2.11	2.06	1.87
	0.5	1.47	1.85	2.47	1.83	1.86	2.25	2.23	2.00
	0.55	1.51	1.94	2.69	1.96	1.94	2.38	2.40	2.13
	0.6	1.55	2.03	2.92	2.09	2.02	2.51	2.58	2.27
	0.65	1.59	2.13	3.15	2.24	2.10	2.64	2.76	2.40
	0.7	1.63	2.24	3.18	2.39	2.18	2.77	2.94	2.53
	0.75	1.66	2.37	3.19	2.56	2.25	2.90	3.12	2.64
	0.8	1.70	2.52	3.20	2.72	2.33	3.04	3.18	2.73
	0.85	1.73	2.69	3.21	2.90	2.40	3.11	3.23	2.80
	0.9	1.76	2.89	3.24	3.07	2.46	3.15	3.25	2.84
	0.95	1.79	3.11	3.28	3.25	2.52	3.17	3.27	2.85
≥1	1.80	3.30	3.33	3.33	2.57	3.23	3.30	2.82	
Overhang	0.25	1.09	1.21	1.28	1.20	1.17	1.26	1.23	1.20
	0.3	1.11	1.26	1.34	1.27	1.22	1.32	1.27	1.24
	0.35	1.13	1.30	1.39	1.33	1.26	1.39	1.32	1.28
	0.4	1.15	1.35	1.46	1.38	1.30	1.46	1.38	1.32
	0.45	1.16	1.40	1.52	1.43	1.33	1.53	1.46	1.36
	0.5	1.18	1.45	1.59	1.48	1.35	1.60	1.54	1.40
	0.55	1.20	1.51	1.66	1.52	1.38	1.67	1.62	1.44
	0.6	1.21	1.56	1.73	1.57	1.40	1.74	1.70	1.47
	0.65	1.22	1.62	1.81	1.61	1.42	1.81	1.79	1.51
	0.7	1.24	1.68	1.88	1.66	1.45	1.88	1.87	1.55
	0.75	1.25	1.74	1.95	1.72	1.48	1.94	1.94	1.58
	0.8	1.26	1.80	2.02	1.77	1.51	2.00	2.01	1.61
	0.85	1.27	1.86	2.09	1.84	1.56	2.06	2.06	1.64
	0.9	1.28	1.92	2.15	1.91	1.61	2.11	2.10	1.67
	0.95	1.29	1.99	2.21	1.98	1.67	2.15	2.13	1.70
≥1	1.30	2.06	2.26	2.07	1.75	2.19	2.14	1.72	
Side Fins	0.25	1.13	1.11	1.18	1.11	1.21	1.14	1.16	1.23
	0.3	1.15	1.13	1.22	1.13	1.22	1.17	1.22	1.27
	0.35	1.17	1.15	1.26	1.15	1.24	1.20	1.26	1.32

0.4	1.19	1.17	1.29	1.17	1.27	1.23	1.29	1.36
0.45	1.21	1.19	1.32	1.19	1.30	1.25	1.31	1.41
0.5	1.22	1.20	1.35	1.20	1.34	1.27	1.33	1.46
0.55	1.24	1.22	1.38	1.22	1.38	1.29	1.34	1.50
0.6	1.25	1.23	1.40	1.23	1.42	1.31	1.35	1.55
0.65	1.27	1.24	1.42	1.25	1.47	1.32	1.36	1.58
0.7	1.28	1.26	1.44	1.26	1.51	1.34	1.36	1.61
0.75	1.30	1.27	1.46	1.27	1.55	1.35	1.37	1.64
0.8	1.31	1.28	1.48	1.29	1.59	1.37	1.38	1.65
0.85	1.32	1.30	1.49	1.30	1.62	1.38	1.39	1.65
0.9	1.34	1.31	1.51	1.31	1.65	1.40	1.40	1.64
0.95	1.35	1.32	1.53	1.32	1.67	1.42	1.42	1.61
≥1	1.36	1.33	1.55	1.33	1.69	1.44	1.45	1.57

Table 4-13 Coefficients of Shading Equivalent Factors for Latitudes less than 15 °N

Shading Equivalent Factors (SEF) for latitudes less than 15 °N									
SEF	PF	North	East	South	West	North-East	South-East	South-West	North-West
Overhang + Fins	0.25	1.38	1.33	1.30	1.34	1.42	1.41	1.37	1.42
	0.3	1.44	1.42	1.35	1.42	1.49	1.46	1.41	1.52
	0.35	1.50	1.50	1.42	1.50	1.57	1.52	1.47	1.63
	0.4	1.56	1.59	1.50	1.59	1.66	1.59	1.54	1.73
	0.45	1.61	1.67	1.59	1.69	1.76	1.67	1.61	1.84
	0.5	1.67	1.76	1.68	1.80	1.87	1.75	1.70	1.94
	0.55	1.72	1.85	1.79	1.90	1.98	1.85	1.80	2.05
	0.6	1.77	1.94	1.89	2.02	2.09	1.94	1.89	2.15
	0.65	1.82	2.02	1.99	2.13	2.20	2.04	2.00	2.25
	0.7	1.86	2.11	2.08	2.24	2.31	2.15	2.10	2.36
	0.75	1.90	2.19	2.17	2.35	2.42	2.25	2.21	2.46
	0.8	1.94	2.28	2.25	2.46	2.53	2.35	2.31	2.55
	0.85	1.98	2.36	2.31	2.56	2.64	2.45	2.42	2.65
	0.9	2.02	2.44	2.35	2.66	2.74	2.54	2.52	2.74
0.95	2.05	2.51	2.38	2.75	2.84	2.63	2.61	2.83	
≥1	2.08	2.58	2.38	2.83	2.93	2.71	2.70	2.91	
Overhang	0.25	1.15	1.19	1.09	1.20	1.17	1.08	1.04	1.18
	0.3	1.17	1.23	1.07	1.24	1.22	1.12	1.08	1.21
	0.35	1.20	1.28	1.07	1.29	1.26	1.16	1.12	1.25
	0.4	1.22	1.32	1.07	1.33	1.30	1.19	1.17	1.29
	0.45	1.24	1.37	1.09	1.38	1.33	1.23	1.21	1.32
	0.5	1.26	1.42	1.12	1.42	1.37	1.28	1.25	1.35
	0.55	1.28	1.46	1.15	1.46	1.40	1.32	1.29	1.39
	0.6	1.30	1.51	1.18	1.50	1.43	1.36	1.33	1.42
	0.65	1.32	1.55	1.22	1.55	1.46	1.40	1.37	1.45
	0.7	1.33	1.60	1.26	1.59	1.48	1.43	1.40	1.48
0.75	1.35	1.64	1.29	1.62	1.51	1.47	1.44	1.50	
0.8	1.37	1.67	1.32	1.66	1.53	1.51	1.47	1.53	

	0.85	1.38	1.71	1.35	1.70	1.55	1.54	1.51	1.56
	0.9	1.39	1.74	1.37	1.73	1.57	1.56	1.54	1.58
	0.95	1.40	1.77	1.38	1.77	1.59	1.59	1.56	1.61
	≥1	1.41	1.79	1.38	1.80	1.61	1.61	1.59	1.63
Side Fins	0.25	1.17	1.10	1.06	1.10	1.15	1.14	1.16	1.16
	0.3	1.20	1.12	1.11	1.12	1.18	1.18	1.21	1.19
	0.35	1.23	1.13	1.16	1.14	1.21	1.20	1.25	1.22
	0.4	1.26	1.15	1.20	1.15	1.24	1.23	1.29	1.25
	0.45	1.28	1.16	1.23	1.17	1.27	1.25	1.31	1.28
	0.5	1.30	1.18	1.25	1.19	1.30	1.27	1.34	1.30
	0.55	1.32	1.19	1.27	1.20	1.33	1.29	1.36	1.33
	0.6	1.34	1.20	1.29	1.22	1.36	1.31	1.37	1.35
	0.65	1.36	1.21	1.30	1.23	1.38	1.34	1.38	1.38
	0.7	1.38	1.22	1.31	1.24	1.41	1.36	1.40	1.40
	0.75	1.40	1.23	1.33	1.26	1.43	1.38	1.41	1.42
	0.8	1.42	1.24	1.34	1.27	1.46	1.41	1.43	1.44
	0.85	1.43	1.25	1.35	1.28	1.48	1.44	1.45	1.47
	0.9	1.45	1.26	1.37	1.29	1.50	1.47	1.47	1.49
	0.95	1.46	1.27	1.39	1.31	1.52	1.50	1.50	1.51
≥1	1.47	1.28	1.42	1.32	1.53	1.54	1.53	1.53	

When calculating the SEF for a fenestration oriented in a non-cardinal direction, it shall be categorized either under a particular cardinal direction or a primary inter-cardinal direction if its orientation is within the range of ± 22.5 degrees of the cardinal or primary inter-cardinal direction.

For example, if a fenestration is oriented 15 degrees east of south, then for calculating the SEF, it's orientation should be considered either as south or south-east.

The following requirement applies when calculating the Equivalent SHGC.

- 1) The maximum allowable SHGC of glazing shall be 0.9.
- 2) Any surrounding man-made or natural sunlight obstructers shall be considered as a permanent shading of PF equal to 0.4 if
 - i. the distance between the vertical fenestration of the building, for which compliance is shown, and surrounding

man-made or natural sunlight obstructers is less than or equal to twice the height of the surrounding man-made or natural sunlight obstructers; (Refer Figure 4.20) and

- ii. the surrounding man-made or natural sunlight obstructers shade the façade for at least 80% of the total time that the façade is exposed to direct sun light on a summer solstice. Compliance shall be shown using a sun path diagram for summer solstice super-imposed on the building plan.

21st June is considered as the Summer solstice which is the longest day in the year. An example showing compliance using the sunpath diagram is shown in Figure 4.30.

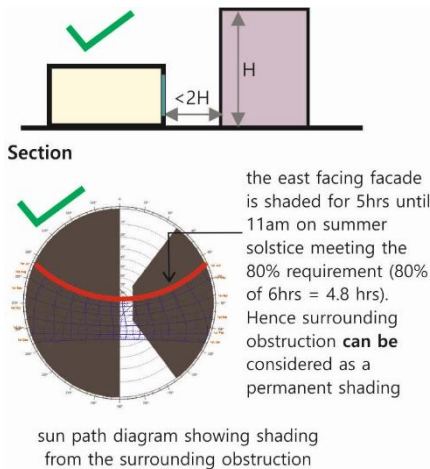
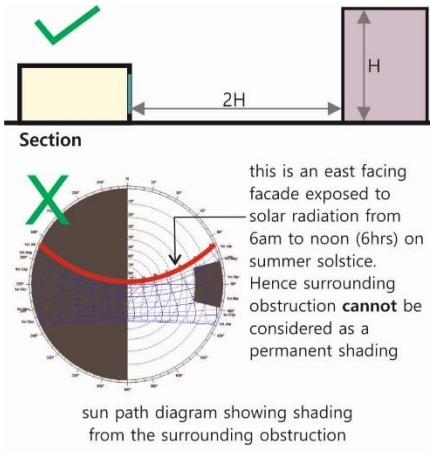

Figure 4.30 Using sunpath for showing compliance for surrounding obstruction

- 3) Vertical fenestration, located such that its bottom is more than 2.2 m above the level of the floor, is exempt from the SHGC requirements in Table 4-10, if the following conditions are complied with:

- i. The Total Effective Aperture (EA) for the elevation is less than 0.25, including all fenestration areas more than 1.0 meter above the floor level; and,

$$\text{Total EA} = \text{VLT} * \text{WWR}$$

WWR should be determined separately for horizontal and vertical fenestrations as follows.

For horizontal fenestrations,

$$EA = \frac{\text{Skylight area} * \text{VLT}}{\text{gross roof area above the daylight area}}$$

For vertical fenestrations,

Determine the area of daylight window and the vision window for each fenestration in all orientations as shown in Figure 4.31.

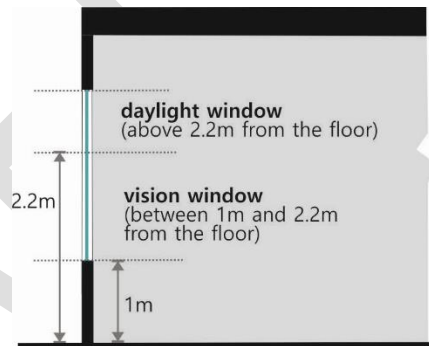

Figure 4.31 Daylight and vision window

Thus, fenestrations until the height of 1meter from the floor level is not considered for the calculation.

The window area, for the purposes of determining effective aperture shall not include windows located in light wells when the angle of obstruction (α) of objects obscuring the sky dome is greater than 70°, measured from the horizontal, nor shall it include window area located below a height of 1 m.

Then, calculate the total EA as follows

$$EA = \frac{[\text{daylight window area} * \text{VLT}] + [\frac{1}{2}(\text{vision window area}) * \text{VLT}]}{\text{gross wall area}}$$

ii. An interior light shelf is provided at the bottom of this fenestration area, with a projection factor on interior side not less than:

- a. 0.1 for E-W, SE, SW, NE, and NW orientations

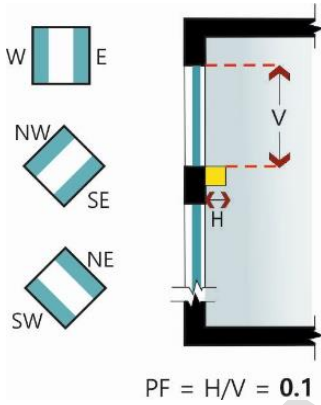

Figure 4.32 PF for interior light shelf

- b. 0.5 for S orientation, and

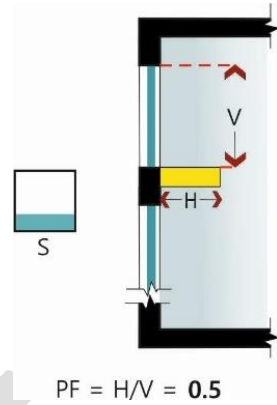

Figure 4.33 PF for south interior light shelf

- c. 0.35 for N orientation when latitude is less than 15°N

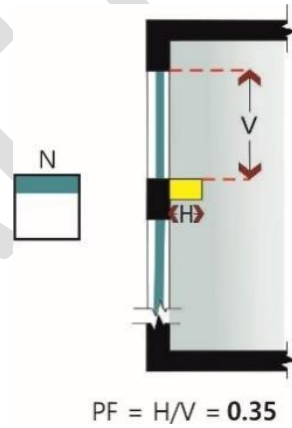

Figure 4.34 PF for north interior light shelf

Example 4-D

A 5,400 m² two story office building in Delhi is trying to achieve ECBC level compliance. It has a rectangular layout (90 m x 30 m) with floor to floor height of 4.0 m and floor area is evenly distributed over the two floors. Windows are either east or west facing and equally distributed on the two floors. The windows are all 1.85m in length and 2.165m in height with an overhang of 0.85 m. Cill level is 1.385 m above floor level. The overall glazing area is 384 m². SHGC of the glazing in the East/West Fenestration is 0.30; area weighted U-Factor is 3.0 W/m².K. VLT of the glazing in all orientation is 0.5. Will the vertical fenestration comply with the ECBC from the prescriptive approach?

Answer:

Table 4-10 and §4.3.3 lists the U-factor, SHGC and VLT requirements for vertical fenestration for ECBC compliant buildings. The building is located in Delhi (Latitude: 28°70' N, Longitude: 77°10'E), which falls under the composite climate, as per Appendix B, Table 12.1. To fulfil prescriptive requirements, Window to Wall ratio ≤ 40%, SHGC ≤ 0.27, U-factor ≤ 3.0 W/m².K, and VLT ≥ 0.27.

Total Floor area = 5400 m²

Total wall area = 2 x (2x ((90m x 4m) + (30m x 4m))) = 1,920 m²

Total Fenestration area = 384 m²

Window to Wall Ratio (WWR) = 384/1,920 = 20%

As per the calculations, the building has a WWR of 20%, thus complying with the requirement for WWR. The U-factor is also less than 3.0 W/m².K. Similarly the VLT is 0.45, which is greater than the minimum specified value of 0.27, thus complying with the u-factor and VLT requirement.

Equivalent SHGC Calculation

As the windows have an overhang, this case will fall under the exception, and the *equivalent SHGC* value will be calculated as per *Equation 4.1*, i.e.

$$SEF = (C_3 \times PF^3) + (C_2 \times PF^2) + (C_1 \times PF) + C_0$$

Where,

PF= Projection Factor, and,

C₀, C₁, C₂, C₃ are coefficients of Shading Equivalent Factors (SEF), listed in Table 4-12 and

Shading Equivalent Factors (SEF) for latitudes greater than or equal to 15°N									
SEF	PF	North	East	South	West	North-East	South-East	South-West	North-West
Overhang + Fins	0.25	1.25	1.37	1.58	1.36	1.47	1.47	1.42	1.53
	0.3	1.29	1.48	1.72	1.43	1.54	1.65	1.57	1.58
	0.35	1.34	1.58	1.88	1.51	1.62	1.81	1.73	1.65
	0.4	1.39	1.67	2.06	1.61	1.70	1.97	1.89	1.75
	0.45	1.43	1.76	2.26	1.71	1.78	2.11	2.06	1.87
	0.5	1.47	1.85	2.47	1.83	1.86	2.25	2.23	2.00
	0.55	1.51	1.94	2.69	1.96	1.94	2.38	2.40	2.13
	0.6	1.55	2.03	2.92	2.09	2.02	2.51	2.58	2.27
	0.65	1.59	2.13	3.15	2.24	2.10	2.64	2.76	2.40
	0.7	1.63	2.24	3.18	2.39	2.18	2.77	2.94	2.53
	0.75	1.66	2.37	3.19	2.56	2.25	2.90	3.12	2.64
	0.8	1.70	2.52	3.20	2.72	2.33	3.04	3.18	2.73
	0.85	1.73	2.69	3.21	2.90	2.40	3.11	3.23	2.80
	0.9	1.76	2.89	3.24	3.07	2.46	3.15	3.25	2.84
	0.95	1.79	3.11	3.28	3.25	2.52	3.17	3.27	2.85
≥1	1.80	3.30	3.33	3.33	2.57	3.23	3.30	2.82	
Overhang	0.25	1.09	1.21	1.28	1.20	1.17	1.26	1.23	1.20
	0.3	1.11	1.26	1.34	1.27	1.22	1.32	1.27	1.24
	0.35	1.13	1.30	1.39	1.33	1.26	1.39	1.32	1.28
	0.4	1.15	1.35	1.46	1.38	1.30	1.46	1.38	1.32
	0.45	1.16	1.40	1.52	1.43	1.33	1.53	1.46	1.36
	0.5	1.18	1.45	1.59	1.48	1.35	1.60	1.54	1.40
	0.55	1.20	1.51	1.66	1.52	1.38	1.67	1.62	1.44
	0.6	1.21	1.56	1.73	1.57	1.40	1.74	1.70	1.47
	0.65	1.22	1.62	1.81	1.61	1.42	1.81	1.79	1.51
	0.7	1.24	1.68	1.88	1.66	1.45	1.88	1.87	1.55
	0.75	1.25	1.74	1.95	1.72	1.48	1.94	1.94	1.58
	0.8	1.26	1.80	2.02	1.77	1.51	2.00	2.01	1.61
0.85	1.27	1.85	2.09	1.81	1.54	2.06	2.06	1.64	

4.3.3.1 U-factor exception

Buildings with air conditioning systems usually have a requirement to keep interiors at a consistently comfortable temperature compared to outdoor conditions. Hence the fenestrations are largely fixed. Thus, a good U-value is necessary to reduce heat gains and air conditioning energy use. In such cases, a double-glazed unit is usually used. Whereas, in unconditioned buildings, natural ventilation through openable fenestrations could be used to maintain comfortable conditions inside the space. Having a good U-value for such openable fenestrations does not serve any purpose. Hence the Code offers an exception to meeting the U-

factor requirements as per Table 4-10 for unconditioned buildings.

As per the Code,

Vertical fenestration on all unconditioned buildings or unconditioned spaces may have a maximum U-factor of 5 W/m².K provided they comply with all conditions mentioned in Table 4-14.

The effective SHGC requirement can be met if the fenestration has adequate shading devices. Thus, it means that shading is critical to achieve indoor comfort for unconditioned buildings.

Table 4-14 U-factor (W/m².K) Exemption Requirements for Shaded Building

Building Type	Climate zone	Orientation	Maximum Effective SHGC	Minimum VLT	PF
Unconditioned buildings or unconditioned spaces	All except cold	Non-North for all latitudes and North for latitude < 15°N	0.27	0.27	≥0.40
		North for latitude > 15°N	0.27	0.27	0.0

4.3.4 Skylights

Skylight Roof Ratio or SRR determines the percentage of skylight area to the roof area. More SSR would mean more glazed area in the roof. The advantage of a skylight is that it brings light into deeper spaces. Unlike walls, roof has minimal obstruction of the surrounding, helping bring unobstructed light. Solar radiation is intense on a roof than a wall. Hence limiting skylight area on the roof is important to control unwanted heat gains.

gross exterior roof area, is limited to a maximum of 5% for ECBC Building, ECBC+ Building, and SuperECBC Building, when using the Prescriptive Method for compliance

As per the Code,

Skylights shall comply with the maximum U-factor and maximum SHGC requirements of Table 4-15. Skylight roof ratio (SRR), defined as the ratio of the total skylight area of the roof, measured to the outside of the frame, to the

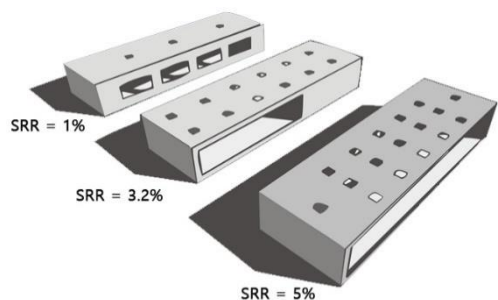

Figure 4.35 Skylight Roof Ratio (SRR)

Table 4-15 Skylight U-factor and SHGC Requirements (U-factor in W/m².K)

Climate	Maximum U-factor	Maximum SHGC
All climatic zones	4.25	0.35

Exception to §4.3.4 **Error! Reference source not found.** Skylights in temporary roof coverings or awnings over unconditioned spaces.

4.3.5 Building Envelope Trade-Off Method

This is a systems-based approach, where the thermal performance of individual components can be reduced if compensated by higher efficiency in other building components. For example, using higher wall insulation could compensate for a less stringent U-factor requirement for fenestrations, or vice versa. These trade-offs typically occur within major building systems – roofs, walls, fenestrations, overhangs, etc.

This method offers the designer more flexibility than strictly following the prescribed values for individual elements. Trade-offs are permitted only between building envelope components. It

is not possible, for instance, to make trade-offs against improvements in the lighting or HVAC systems.

However, this makes using the envelope trade-off option more complicated than the prescriptive method. It is necessary to calculate the surface area of each exterior and semi-exterior surface; all fenestration areas must also be calculated separately for each orientation. To show compliance, the Envelope Performance Factor (EPF) of the Proposed Design and the Baseline Design is required to be calculated. The Baseline Design exactly complies with the prescriptive requirements of building envelope.

The building envelope of the proposed design complies with ECBC if

$$EPF_{\text{OF PROPOSED DESIGN}} < EPF_{\text{OF BASELINE DESIGN}}$$

The envelope performance factor shall be calculated using the following equations.

Equation 4.1: $EPF_{\text{Total}} = EPF_{\text{Roof}} + EPF_{\text{Wall}} + EPF_{\text{Fenest}}$

$$EPF_{\text{Roof}} = c_{\text{Roof}} \sum_{s=1}^n U_s A_s$$

$$EPF_{\text{Wall}} = c_{\text{Wall,Mass}} \sum_{s=1}^n U_s A_s + c_{\text{Wall,Other}} \sum_{s=1}^n U_s A_s$$

$$\begin{aligned}
EPF_{Fenest} = & c_{1Fenest,North} \sum_{w=1}^n U_w A_w + c_{2Fenest,North} \sum_{w=1}^n SHGC_w M_w A_w \\
& + c_{1Fenest,South} \sum_{w=1}^n U_w A_w + c_{2Fenest,South} \sum_{w=1}^n SHGC_w M_w A_w \\
& + c_{1Fenest,East} \sum_{w=1}^n U_w A_w + c_{2Fenest,East} \sum_{w=1}^n SHGC_w M_w A_w \\
& + c_{1Fenest,West} \sum_{w=1}^n U_w A_w + c_{2Fenest,West} \sum_{w=1}^n SHGC_w M_w A_w \\
& + c_{1Fenest,Skylight} \sum_{w=1}^n U_w A_w + c_{2Fenest,Skylight} \sum_{w=1}^n SHGC_w A_w
\end{aligned}$$

EPF _{Roof}	Envelope performance factor for roofs. Other subscripts include walls and fenestration.
A _s , A _w	The area of a specific envelope component referenced by the subscript "s" or for windows the subscript "w".
SHGC _w	The solar heat gain coefficient for windows (w). SHGC _s refers to skylights.
M _w	A multiplier for the window SHGC that depends on the projection factor of an overhang or sidefin.
U _s	The U-factor for the envelope component referenced by the subscript "s".
C _{Roof}	A coefficient for the "Roof" class of construction. Values of "c" are taken from Table 12-1 through Table 12-5 for each class of construction.
C _{wall}	A coefficient for the "Wall"
C _{1 Fenest}	A coefficient for the "Fenestration U-factor"
C _{2 Fenest}	A coefficient for the "Fenestration SHGC"

Table 4-16 Envelope Performance Factor Coefficients – Composite Climate

	Daytime Business, Educational, Shopping Complex		24-hour Business, Hospitality, Health Care, Assembly	
	C factor U-factor	C factor SHGC	C factor U-factor	C factor SHGC
Mass Walls	5.39	-	7.91	-
Curtain Walls, Other	7.83	-	10.32	-
Roofs	14.93	-	17.88	-
North Windows	0.33	81.08	-2.83	119.14
South Windows	-2.30	221.07	-3.54	294.00
East Windows	-1.17	182.64	-3.23	255.91
West Windows	-0.74	182.11	-2.85	252.61

Table 4-17 Envelope Performance Factor Coefficients – Hot and Dry Climate

	Daytime Business, Educational, Shopping Complex		24-hour Business, Hospitality, Health Care, Assembly	
	C factor U-factor	C factor SHGC	C factor U-factor	C factor SHGC
Mass Walls	6.4	-	12.09	-
Curtain Walls, Other	9.58	-	12.30	-
Roofs	14.82	-	21.12	-
North Windows	-0.37	101.66	0.13	136.80
South Windows	-1.35	252.90	-0.21	327.51
East Windows	-0.85	219.91	-0.16	293.19
West Windows	-0.80	226.57	0.15	300.80

Table 4-18 Envelope Performance Factor Coefficients – Warm and Humid Climate

	Daytime Business, Educational, Shopping Complex		24-hour Business, Hospitality, Health Care, Assembly	
	C factor U-factor	C factor SHGC	C factor U-factor	C factor SHGC
Mass Walls	4.91	-	9.66	-
Curtain Walls, Other	7.98	-	13.32	-
Roofs	13.15	-	19.38	-
North Windows	-1.87	102.83	-3.26	135.84
South Windows	-2.62	218.31	-3.54	277.61
East Windows	-2.07	182.40	-3.37	238.68
West Windows	-2.22	184.75	-3.16	235.95

Table 4-19 Envelope Performance Factor Coefficients – Temperate Climate

	Daytime Business, Educational, Shopping Complex		24-hour Business, Hospitality, Health Care, Assembly	
	C factor U-factor	C factor SHGC	C factor U-factor	C factor SHGC
Mass Walls	2.35	-	5.06	-
Curtain Walls, Other	4.50	-	7.29	-
Roofs	11.78	-	15.15	-
North Windows	-4.17	106.23	-5.58	123.43
South Windows	-4.66	193.63	-5.90	233.84
East Windows	-4.46	211.50	-5.87	267.49
West Windows	-4.67	215.20	-5.33	262.27

Table 4-20 Envelope Performance Factor Coefficients – Cold Climate

	Daytime Business, Educational, Shopping Complex		24-hour Business, Hospitality, Health Care, Assembly	
	C factor U-factor	C factor SHGC	C factor U-factor	C factor SHGC
Mass Walls	17.65	-	12.10	-
Curtain Walls, Other	14.36	-	17.65	-
Roofs	5.79	-	16.02	-
North Windows	-2.40	0.32	8.23	50.36
South Windows	-2.65	-18.75	0.08	172.87
East Windows	-2.78	-16.67	3.83	168.83
West Windows	-2.84	-15.53	5.60	159.43

Example 4-E

Demonstrate envelope compliance for the following building using the Building Envelope Trade-off method.

A 1000 m² single story 24-hour use office building in Ahmedabad is trying to achieve ECBC level compliance. Each side has a band window. The materials for the envelope has already been selected, prior to opting for ECBC compliance. Check if the building envelope will be ECBC compliant as per Building Envelope Trade-off method. The dimensions of the building envelope are as follows:

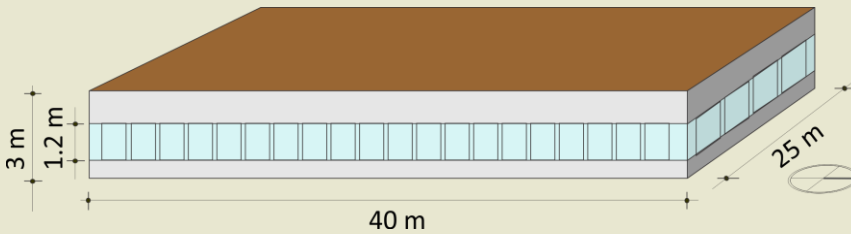

Answer:

According to Table 11-1, Appendix B, Ahmedabad falls under the hot and dry climate zone. To prove compliance through the prescriptive approach, U values, and SHGC must comply with requirements listed in Table 4-4, Table 4-7, Table 4-10 and VLT and window to wall ratio with requirements in § 4.3.3 for a 24-hour use building in the hot and dry climate zone. The table below lists thermal properties of the building envelope components and the corresponding prescriptive requirements for ECBC complaint buildings.

Table 4-3-1 Prescriptive Requirements and Proposed Thermal Properties

	Prescriptive U-factor (W/m ² .K)			Proposed U-factor (W/m ² .K)			Area (m ²)
Wall 1– North, South	=<0.63			0.25			90
Wall 2– East, West	=<0.63			0.25			144
Roof	=<0.33			0.4			1000
	U-factor	SHGC	VLT	U-factor	SHGC	VLT	
Window – South	=<3.0	=<0.27	=<0.27	1.8	0.25	0.27	30
Window – North	=<3.0	=<0.5	=<0.27	1.8	0.25	0.27	30
Window-East	=<3.0	=<0.27	=<0.27	1.8	0.25	0.27	48
Window-West	=<3.3	=<0.27	=<0.27	1.8	0.25	0.27	48

U-value of the roof of the proposed building, at 0.4 W/m².K does not fulfil prescriptive requirements. Similarly, §4.3.3 requires the WWR to be less than 40%. This condition is fulfilled in the proposed buildings as can be seen in the calculations below

Total Fenestration Area_{North, South} = 2 x (25m x 1.2m) = 60 m²

Wall Area_{North, South} = 2 x (25m x 3m) = 150 m²

Total Fenestration Area_{East, West} = 2 x (40m x 1.2m) = 96 m²

Total Wall Area_{East, West} = 2 x (40m x 3m) = 240 m²

Total Fenestration Area = 156 m², Total Wall Area = 390 m²

WWR = 156/390 = 0.4 or 40%

Hence, this building will not be compliant if the prescriptive approach is followed.

Compliance through Building Envelope Trade-off method

Envelope performance factor (EPF) for the Standard Building and Proposed Building must be compared. As per the Building Envelope Trade-off method, the envelope performance factor (EPF) shall be calculated using the following equations:

Equation 11.1 $EPF_{Total} = EPF_{Roof} + EPF_{Wall} + EPF_{Fenest}$

Where,

$$EPF_{Roof} = C_{Roof} \sum_{s=1}^n U_s A_s$$

$$EPF_{Wall} = C_{Wall,Mass} \sum_{s=1}^n U_s A_s + C_{Wall,Other} \sum_{s=1}^n U_s A_s$$

$$\begin{aligned}
 EPF_{Fenest} = & C_{1Fenest,North} \sum_{w=1}^n U_w A_w + C_{2Fenest,North} \sum_{w=1}^n \frac{SHGC_w}{SEF_w} A_w \\
 & + C_{1Fenest,South} \sum_{w=1}^n U_w A_w + C_{2Fenest,South} \sum_{w=1}^n \frac{SHGC_w}{SEF_w} A_w \\
 & + C_{1Fenest,East} \sum_{w=1}^n U_w A_w + C_{2Fenest,East} \sum_{w=1}^n \frac{SHGC_w}{SEF_w} A_w \\
 & + C_{1Fenest,West} \sum_{w=1}^n U_w A_w + C_{2Fenest,West} \sum_{w=1}^n \frac{SHGC_w}{SEF_w} A_w
 \end{aligned}$$

Standard Building EPF will be derived from U-factors, SHGCs and VLTs of walls, roofs and fenestration from Table 4-4, Table 4-7, Table 4-10 and § 4.3.3 for a 24-hour use building in the hot and dry climate zone. Values of C are from 24-hour Office building in hot and dry climatic zone for each class of construction from Table 4-16. Since There is no shading for the windows, Mw will not be considered.

Step 1: Calculation of EPF Proposed Building from actual envelope properties

$$EPF_{Roof,Actual} = C_{Roof} \sum_{s=1}^n U_s A_s$$

$$= 14.82 \times 0.40 \times 1,000 = 5,928$$

$$EPF_{Wall,Actual} = C_{Wall,Mass} \sum_{s=1}^n U_s A_s + C_{Wall,Other} \sum_{s=1}^n U_s A_s$$

$$= (6.4 \times 0.25 \times 90) + (6.4 \times 0.25 \times 144) = 374.4$$

$$EPF_{Fenest} = EPF_{Fenest, North} + EPF_{Fenest, South} + EPF_{Fenest, East} + EPF_{Fenest, West}$$

$$EPF_{Fenest} = C_{1Fenest, \sum_{w=1}^n U_w A_w} + C_{2Fenest, \sum_{w=1}^n \frac{SHGC_w}{SEF_w} A_w}$$

Hence,

$$EPF_{Fenest, North} = -0.37 \times 1.8 \times 30 + 101.66 \times 0.25 \times 30 = -19.98 + 762.45 = 742.47$$

$$EPF_{Fenest, South} = -1.35 \times 1.8 \times 30 + 252.90 \times 0.25 \times 30 = -72.9 + 1,896.75 = 1,823.85$$

$$EPF_{Fenest, East} = -0.85 \times 1.8 \times 48 + 219.91 \times 0.25 \times 48 = -73.44 + 2,638.9 = 2,565.46$$

$$EPF_{Fenest, West} = -0.80 \times 1.8 \times 48 + 226.57 \times 0.25 \times 48 = -69.12 + 2,718.8 = 2,649.7$$

Therefore,

$$EPF_{Fenest} = 7,781.5$$

$$EPF_{Proposed} = 5,928 + 374.4 + 7,781.5 = 14,083.9$$

Step 2: Calculating EPF *Standard Building* from prescriptive envelope requirements

$$EPF_{Roof,Actual} = C_{Roof} \sum_{s=1}^n U_s A_s$$
$$= 14.82 \times 0.33 \times 1000 = 4,890.6$$

$$EPF_{Wall,Actual} = C_{Wall,Mass} \sum_{s=1}^n U_s A_s + C_{Wall,Other} \sum_{s=1}^n U_s A_s$$
$$= (6.4 \times 0.63 \times 90) + (6.4 \times 0.63 \times 144) = 362.88 + 580.6 = 943.5$$

$$EPF_{Fenest} = EPF_{Fenest, North} + EPF_{Fenest, South} + EPF_{Fenest, East} + EPF_{Fenest, West}$$

Now,

$$EPF_{Fenest, North} = -0.37 \times 3.3 \times 30 + 101.66 \times 0.5 \times 30 = -36.63 + 1,524.9 = 1,488.3$$

$$EPF_{Fenest, South} = -1.35 \times 3.3 \times 30 + 252.9 \times 0.27 \times 30 = -133.7 + 2,048.5 = 1,914.8$$

$$EPF_{Fenest, East} = -0.85 \times 3.3 \times 48 + 219.91 \times 0.27 \times 48 = -134.64 + 2,850 = 2,715.4$$

$$EPF_{Fenest, West} = -0.8 \times 3.3 \times 48 + 226.57 \times 0.27 \times 48 = -126.7 + 2,936 = 2,809.6$$

Therefore, $EPF_{Fenest} = 8,928$

$$EPF_{Baseline} = 4,890.6 + 943.5 + 8,928 = 14,762.2$$

Since $EPF_{Baseline} > EPF_{Proposed}$, therefore the building is compliant with ECBC building envelope requirements.

4.3.5.1.1 *Standard Building EPF Calculation*

EPF of the Standard Building shall be calculated as follows:

- (a) The Standard Building shall have the same building floor area, gross wall area and gross roof area as the Proposed Building. For mixed-use building the space distribution between different typologies shall be the same as the Proposed Design.
- (b) The U-factor of each envelope component shall be equal to the criteria from §4 for each class of construction.
- (c) The SHGC of each window shall be equal to the criteria from §4.3.3.
- (d) Shading devices shall not be considered for calculating EPF for Standard Building (i.e. SEF=1).

DRAFT

5 Comfort Systems & Controls

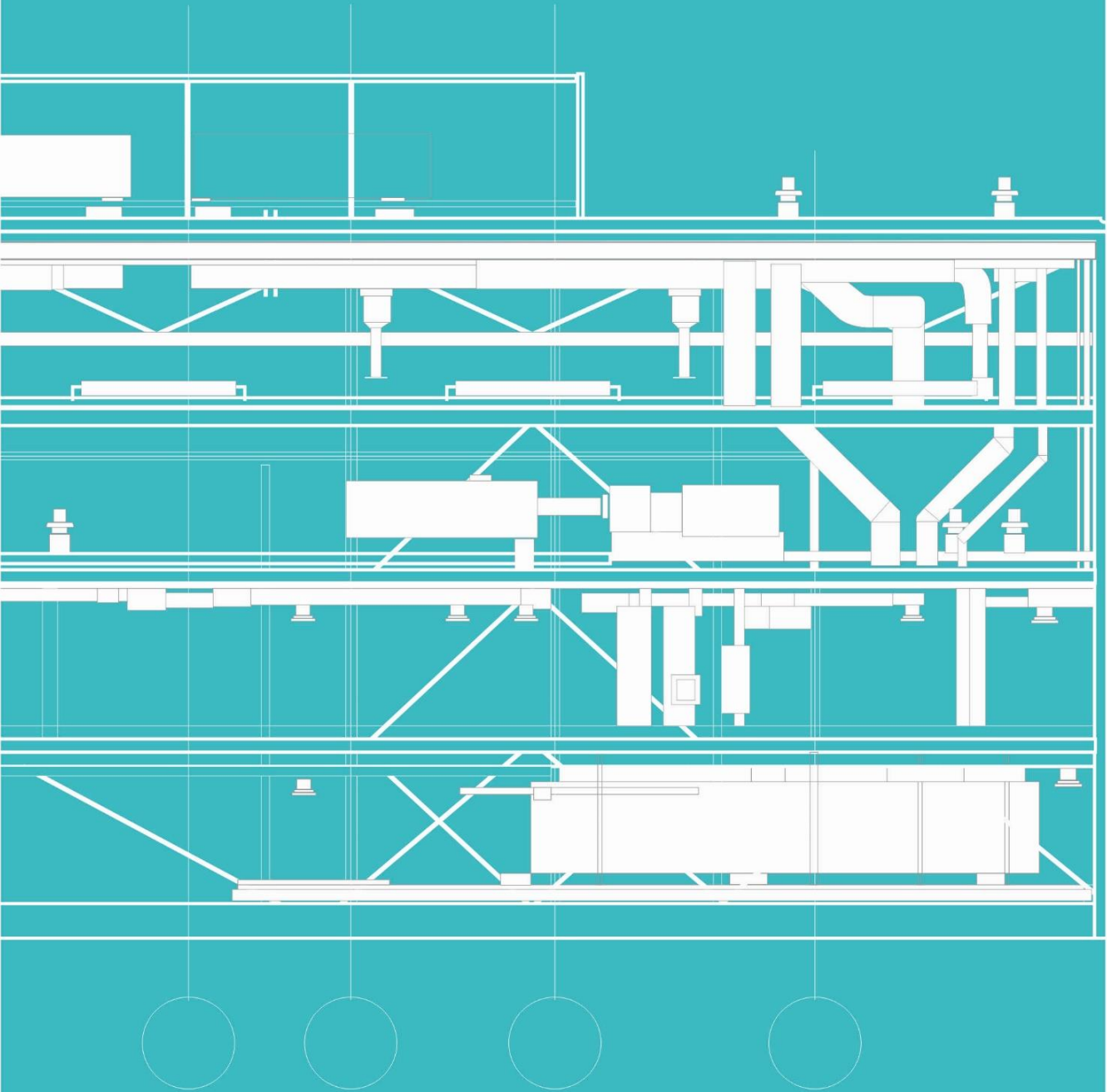

COMFORT SYSTEMS & CONTROLS

INTENT

The second step in achieving energy efficiency is to use efficient cooling/heating equipment to provide thermally comfortable environment to occupants. Beyond equipment efficiency, the interactions of the overall system with all its components and their control mechanism is an important factor in achieving energy reduction. Low energy comfort systems that are climate appropriate can further help in improving energy efficiency.

SECTION ORGANIZATION

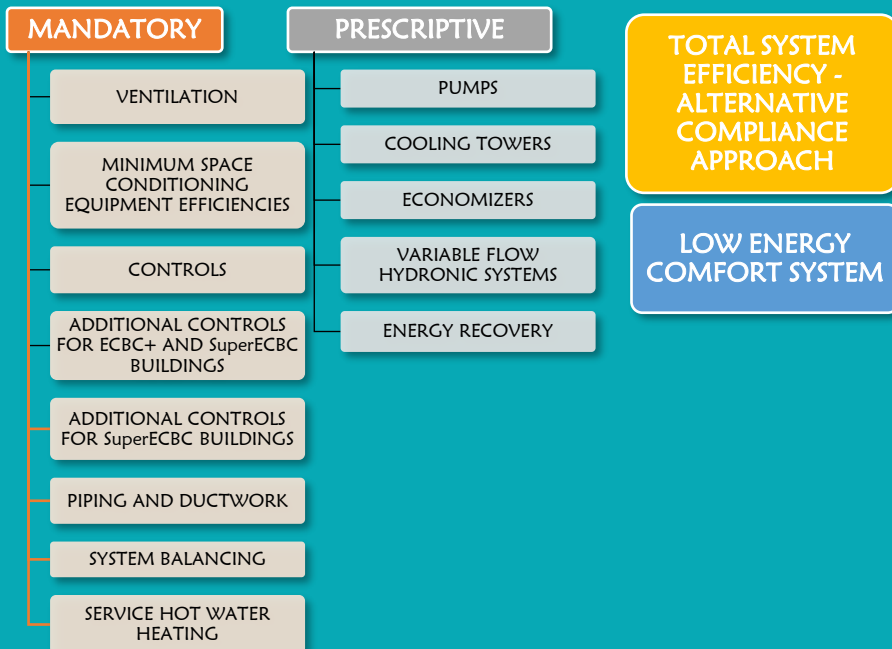

5. COMFORT SYSTEMS & CONTROLS

5.1 General

A building should be designed to keep occupants comfortable. This means providing temperature, air motion and relative humidity within acceptable range for a thermally comfortable condition. In a carefully designed building, the walls, roofs, windows and interior surfaces alone can maintain comfortable interior temperatures for a large part of the year; especially for moderate climate zones.

The desired air temperatures can often be achieved by passive design strategies (a combination of building form, orientation, shading and materials), but controlling humidity, air speeds and air quality can effectively be achieved by mechanical systems.

Thus, although passive measures will improve thermal comfort, air-conditioning may still be required for maintaining comfort conditions through the year.

Introduction to HVAC

Heating, Ventilation and Air Conditioning (HVAC) systems are used to heat or cool buildings to maintain indoor thermal comfort conditions that are acceptable to the human body.

Given the predominantly hot climate in India, coupled with increasing economic prosperity and aspirations, the energy demand for space cooling is rising rapidly in India. HVAC system account for nearly 40 percent of the energy used by commercial buildings in India.

The design as well as efficiency of such systems could further impact the energy consumption of

buildings. The process of optimization must begin with load calculation, and include system design, system selection and installation, commissioning, and ultimately – operations & maintenance. Innovative low-energy comfort systems are highly recommended for augmenting energy savings.

The best HVAC design considers all the interrelated building systems while addressing indoor air quality, thermal comfort, energy consumption, and environmental benefits. Optimizing both the design and the benefits requires that the architect and mechanical system designer address these issues early in the schematic design phase and continually revise subsequent decisions throughout the remaining design process. It is also essential that a process be implemented to monitor proper installation and operation of the HVAC system throughout construction.

Installing a HVAC system can be a significant capital cost to a project, especially for large commercial buildings. A poorly designed HVAC system can easily nullify the benefits of an energy-conserving building design.

In addition to providing heating and cooling, HVAC systems also provide ventilation. This is especially important where air conditioned buildings tend to be sealed. Fresh air from outside is required to flush out the indoor pollutants and odors. This is important for the health, productivity and comfort of occupants.

Environmental concern

The electricity used by the HVAC systems in buildings are supplied from power plants that burn fossil fuels like coal. This is responsible for greenhouse gas emissions which is globally known to cause climate change. Such emissions are attributed as *indirect emissions* to buildings since the source of emissions is at the power plant and not at the point of use. Energy efficient HVAC systems will use less electricity over its

operational lifetime reducing the indirect emissions from buildings.

Apart from the issue of energy use, the use of refrigerants in the HVAC systems is responsible for ozone layer depletion. Most of the refrigerants are greenhouse gases which are responsible for climate change. When refrigerant gases leak from the HVAC equipment during operations or when they are replenished, they end up in the atmosphere. This is called direct emissions from buildings.

The building sector offers many opportunities to reduce the greenhouse gas emissions playing a significant role in environment protection. Thus, building energy efficiency along with energy efficient HVAC system is important to address both direct and indirect greenhouse gas emissions from buildings.

Although compliance with this Code shall ensure an acceptable system performance, designers are encouraged to consider options that exceed these requirements.

Fundamentals of air conditioning

Air conditioning systems fundamentally *transport* heat. Heat is removed from a space to provide cooling and released into a *heat sink*. There are three basic heat sinks – air, water and ground.

Mechanical cooling permits to move heat from lower temperature zone (inside the building) to a higher temperature zone (outside the building), which would otherwise be impossible. Let's understand this better with a water analogy. A submerged building can be compared to a building surrounded by heat in summer. The natural tendency of the water is to flow into the building. Only by pumping it uphill can it be removed from the building. In the same way, natural tendency of heat is to flow into the building from the higher outdoor temperatures. The only way to remove this heat is to pump it

out with a refrigeration machine. This is what a refrigerator and air conditioning machines do.

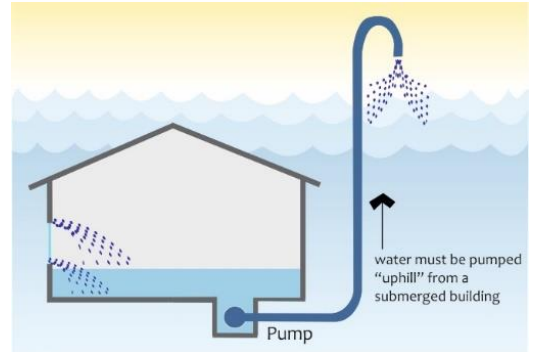

Figure 5.1 Air conditioning analogy

Air conditioners pump heat by using the latent heat of evaporation to pick up heat in one place (by changing liquid to gas) and then releasing the heat through condensation at another place (by changing gas to liquid). There are two basic methods of producing cool air in buildings

1. Compression refrigeration cycle
2. Absorption refrigeration cycle

Compression refrigeration cycle

The compression cycle is the most common. Basic components of a compression air conditioning system include a compressor, condenser (air-cooled or water cooled), and an evaporator. A gaseous working fluid, called as refrigerant, circulates in coils within the system. The compressor and condenser are usually located on the exteriors and the evaporator is located on the interiors.

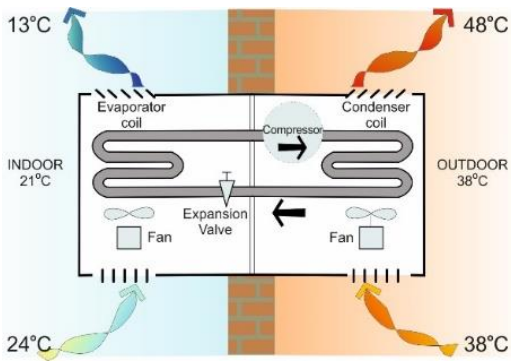

Figure 5.2 Refrigeration cycle

Low pressure liquid refrigerant in the evaporator absorbs heat from the surrounding air or water and gets converted into vapour. It then reaches the compressor where it gets converted to high pressure vapour due to compression. In this process, the temperature of the high pressure vapour increases significantly.

The next step is the condenser where the refrigerant condenses to a high-pressure liquid. Heat rejection at the condenser is achieved by using air or water. The high-pressure liquid refrigerant then goes through the expansion valve and converts into low-pressure liquid ready for heat transfer in the evaporator. This is the refrigeration cycle which continues within the system.

WHERE THE REFRIGERANT EVAPORATES, IT ABSORBS HEAT AND COOLING TAKES PLACE. WHERE IT CONDENSES, IT RELEASES HEAT

Depending on the size and type of the HVAC system, the evaporator and the condenser can be separated or a combined unit. Further there can be many pumps in the system. The condenser can be water cooled or air cooled. But the fundamental refrigeration cycle remains the same. These are discussed in detail in the further sections.

Absorption refrigeration cycle

The absorption cycle produces cooling using heat such as steam, hot water or gas. This system is often appropriate when a source of low-cost heat is available.

The absorption refrigeration cycle works on the same principle as the compressive cycle. Additionally, there is another principle, which is:

Some liquids have a strong tendency to absorb certain vapors (e.g. water vapor is absorbed by liquid lithium bromide or ammonia).

There are no moving parts in this system. Electricity is used only to operate the pumps.

In the chamber A, water evaporates at low temperature (around 4°C) under high vacuum condition. In this process, it draws heat from the incoming chilled water and further cools it down (output). Thus, water is working as the refrigerant here. This chamber is called the evaporator. In order to keep evaporating, the water in the evaporator must be constantly supplied in order for it to keep evaporating.

The water vapour then migrates to chamber B, where it is absorbed by the lithium bromide solution. This chamber is called the absorber. Consequently, the vapor pressure is reduced in the absorber which in turn creates a vacuum in the evaporator. Due to this the water vapor can evaporate to continue the cooling process. Eventually, the lithium bromide will become too dilute to further absorb water.

In chamber C, an external heat source boils the water off the lithium bromide. This is called the generator. The heating media can be steam, hot water, gas or oil. The concentrated lithium bromide is then returned to the absorber, while the water vapor is condensed back into water in chamber D called the condenser. The last step is to return the liquid water back to the evaporator

so that the cycle can continue. Lithium Bromide - water absorption refrigeration systems have a Coefficient of Performance (COP) in the range of 0.65 – 0.70 and can provide chilled water at 6.7°C with a cooling water temperature of 30°C. Systems capable of providing chilled water at 3°C are also available.

Ammonia based systems operate at above atmospheric pressures and are capable of low temperature operation (below 0°C). Absorption machines of capacities in the range of 10–1500 tons are available. Although the initial cost of absorption system is higher than compression system, operational cost is much lower-if waste heat is used.

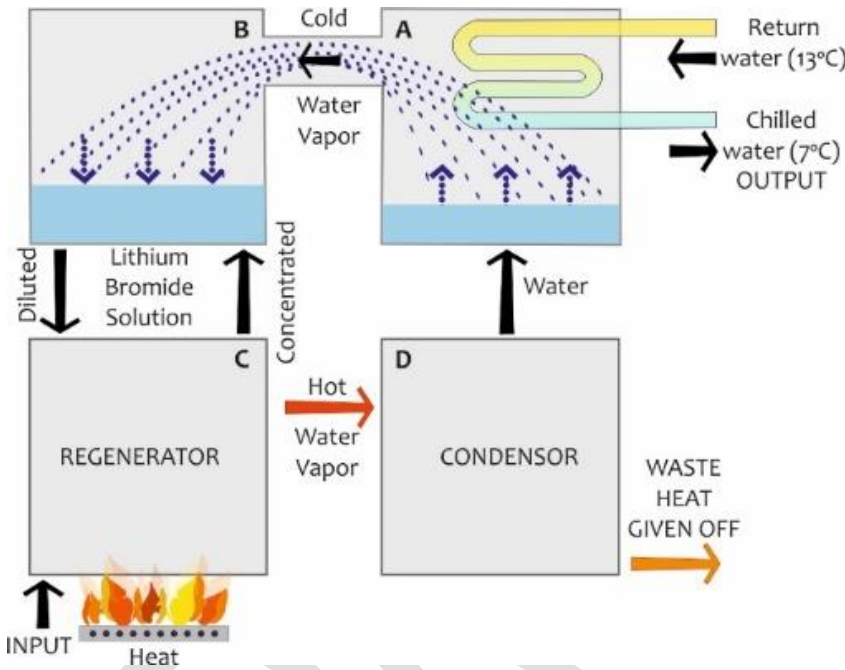

Figure 5.3 Vapor absorption cycle

The ECBC does not specify requirement for efficiency of the vapor absorption system. But requirements for components such as pumps and motors are covered in the Code. The ECBC specifies minimum equipment efficiencies for all HVAC equipment including chillers, unitary air conditioner, split air conditioner, packaged air conditioner, and boilers.

Types of air conditioning systems

There are primarily two main types of air conditioning systems:

1. A direct expansion or “DX” type system in the form of room air conditioners, split

system and packaged air conditioners. Heat exchange takes place directly from the refrigerant within the copper tubes to the air being drawn across the finned coil by an evaporator fan. The DX type systems offer localized solutions for a building’s heating and cooling needs. These systems are typically appropriate for smaller (single-zone) buildings.

2. Central plant system uses chilled water recirculation. Compared to a DX system, a central plant HVAC will be able to provide better thermal comfort and flexibility

Direct Expansion Systems or DX Systems

Unitary air conditioners

These are normally used for cooling individual rooms and provide cooling only when needed. Room air conditioners house all the components of an air conditioning system discussed above in one casing. Their efficiency is generally lower than that of central plant systems.



Figure 5.4 Window air conditioner

Split-system air conditioning systems

This consists of an outdoor metal cabinet that contains the condenser and compressor, and an indoor cabinet that contains the evaporator. In many split-system air conditioners, this indoor cabinet also contains a furnace or the indoor part of a heat pump.



Figure 5.5 Split air conditioner

Packaged air conditioners

A packaged air conditioner is a bigger version of the window air conditioner.

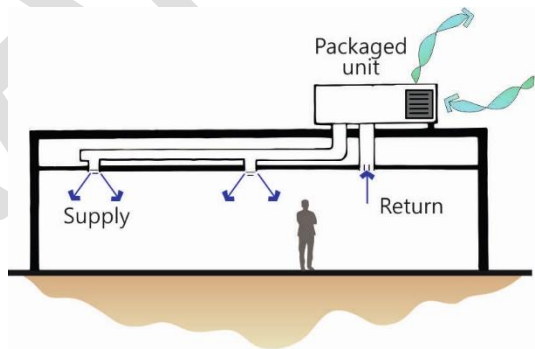

Figure 5.6 Packaged unit located on roof top

In a packaged air conditioner, the evaporator, condenser, and compressor are all located in one cabinet, which usually is placed on a roof or on a concrete slab adjacent to the building. This type of air conditioner is typical in small commercial buildings and also in residential buildings. Air supply and return ducts come from indoors through the building's exterior wall or roof to connect with the packaged air conditioner. The system often includes electric heating coils or a

natural gas furnace. This combination of air conditioner and central heater eliminates the need for a separate furnace indoors.

The packaged system is an all-air system where building is cooled by circulating cool air from the point of generation to the point of supply. Hence it requires extensive duct work for air supply and therefore useful for small to medium sized commercial buildings.

Central Plant Systems

For large buildings, a central plant is better suited for air conditioning. In such systems, chilled water is centrally generated and then piped throughout the building to air handling units serving individual tenant spaces, single floors, or several floors. Ductwork then runs from each air handler to the zones that are served. Chilled water-based systems result in far less ductwork than all-air systems because chilled water piping

is used to convey thermal energy from the point of generation to each point of use.

Chillers

A chiller is essentially a packaged system, which produces chilled water for cooling. A typical chiller is rated between 15 to 1000 tons (53 to 3,500 kW) in cooling power. The chiller rejects heat either to condenser water (in the case of a water-cooled chiller) or to ambient air (in the case of an air-cooled chiller). Water-cooled chillers incorporate the use of cooling towers, which improve heat rejection more efficiently at the condenser than air-cooled chillers. For a water-cooled chiller, the cooling tower rejects heat to the environment through direct heat exchange between the condenser water and cooling air. For an air-cooled chiller, condenser fans move air through a condenser coil. As heat loads increase, water-cooled chillers are more energy-efficient than air-cooled chillers.

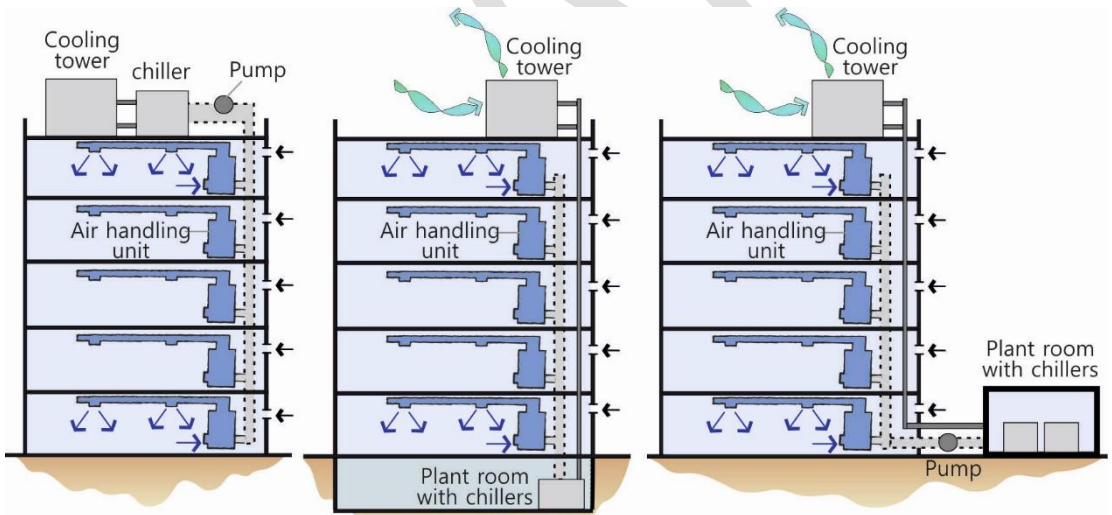

Figure 5.7 Different configurations for a central plant

A chiller plant is a system consisting of many components such as chillers, cooling tower, air handling units and pumps. There are several other components such as the chilled water piping, air supply ducts, valves, controls and so on making a central plant more complex to build

and operate compared to a packaged unit. However, it offers many benefits such as greater flexibility, better controllability, longer life and better efficiency.

All the components of a central plant need not be located in one place for it to function as a system. For example, the chillers can be located in a separate plant room outside the main building or in the basement while the cooling towers can be located on the roof top (Figure 5.7).

What are the different types of chillers?

Chillers are classified according to compressor type. Electric chillers for commercial comfort cooling have centrifugal, screw, scroll, or reciprocating compressors. Centrifugal and screw chillers have one or two compressors. Scroll and reciprocating chillers are built with multiple, smaller compressors.

- Centrifugal chillers are the quiet, efficient, and reliable workhorses of comfort cooling. Although centrifugal chillers are available as small as 70 tons, most are 300 tons or larger.
- Screw chillers are up to 40% smaller and lighter than centrifugal chillers, so are becoming popular as replacement chillers.

Scroll compressors are rotary positive-displacement machines, also fairly new to the comfort cooling market. These small compressors are efficient, quiet, and reliable. Scroll compressors are made in sizes of 1.5 to 15 tons.

5.2 Mandatory Requirements

The Code contains mandatory requirements for the following elements of the HVAC system:

- Natural Ventilation
- Equipment Efficiency
- Controls
- Piping and Ductwork
- System Balancing
- Condensers

- Economizers
- Hydronic Systems

5.2.1 Ventilation

Ventilation in a building is essential for occupant comfort. Indoor air pollution is especially gaining attention today since more and more buildings are being designed as a sealed airtight unit due to air conditioning. This is particularly true of large buildings.

The build-up of indoor pollutants such as carbon dioxide and odor need to be flushed out from the interiors to ensure good indoor air quality. Materials used in the interiors such as furniture, furnishing, paints and finishes, cleaning products and others are known to release chemicals called volatile organic compounds (VOC). This process called off-gassing is continuous. Extensive research in this area has established that the concentration of such VOCs increases over time which has adverse effect on the human health, especially in a closed building.

Diluting the concentration of pollutants with outside air is the most common method for controlling indoor air quality. However, eliminating the pollutants by exhausting it from the space is a more effective method.

As per the Code,

- (a) All habitable spaces shall be ventilated with outdoor air in accordance with the requirements of §5.2.1 and guidelines specified in National Building Code 2016 (Part 8: Building Services, Section 1: Lighting and Natural Ventilation, Subsection 5: Ventilation).

As per the Code, ventilation in the building can be provided by three methods

- i. Natural ventilation
- ii. Mechanical ventilation

Natural ventilation is provided by means of building fenestration and hence does not use energy. Mechanical ventilation is provided by means of HVAC system which is usually integrated with the air conditioning system. Mixed mode ventilation is a combination of natural and mechanical ventilation.

5.2.1.1 Natural Ventilation Design Requirements

Naturally ventilated buildings or spaces in a mixed-mode ventilated building shall:

- (a) Comply with guidelines provided for natural ventilation in NBC.
- (b) Have minimum BEE 3-star rated ceiling fans, if provided with ceiling fans.
- (c) Have exhaust fans complying with minimum efficiency requirements of fans in §5.3, if provided.

Design Guidelines for natural ventilation

Naturally ventilated buildings rely on wind that is naturally prevalent at the site. The fenestrations of the building should be designed to capture the breeze for effective ventilation.

Design guidelines from NBC 2016 have been reproduced here in Box 5-1, keeping in view the

philosophy behind this Guide to include ECBC referenced material in the Guide. However, the exact relevance of these general guidelines in the design of commercial buildings need to be critically examined.

Further, ceiling fans are commonly used to force air circulation in a space for occupant comfort. Ceiling fans are largely considered to be a passive cooling strategy since it uses very less energy. However, the Code requires that the ceiling fans, if provided, should be minimum BEE 3-star rated so that it helps reduce the plug loads of the building.

The Star labeling program by the Bureau of Energy Efficiency mandates that certain products and appliances meet the Minimum Energy Performance Standards (MEPS). An informative label listing the energy consumption of the appliance or the equipment is affixed to a product in order to encourage consumer to make informed choices while purchasing. Ceiling fans, tubelights, CFL, split air conditioner, refrigerator and many other appliances are covered in this program. The program ensures that only the energy efficient models are available in the market.

Design guidelines for ceiling fans is given in Box 5-1 as per NBC 2016, Section 5.7

BOX 5-1 : Design guidelines for natural ventilation

Source: National Building Code 2016

By wind action

- 1) Building need not necessarily be oriented perpendicular to the prevailing outdoor wind; it may be oriented at any convenient angle between 0° and 30° without losing any beneficial aspect of the breeze. If the prevailing wind is from east or west, building may be oriented at 45° to the incident wind so as to diminish the solar heat without much reduction in air motion indoors.
- 2) Inlet openings in the buildings should be well distributed and should be located on the windward side at a low level, and outlet openings should be located on the leeward side. Inlet and outlet openings at high levels may only clear the top air at that level without producing air movement at the level of occupancy.
- 3) Maximum air movement at a particular plane is achieved by keeping the sill height of the opening at 85% of the critical height (such as head level) for the following recommended levels of occupancy:
 - (a) For sitting on chair 0.75 m
 - (b) For sitting on bed 0.60 m
 - (c) For sitting on floor 0.40 m
- 4) Inlet openings should not, as far as possible, be obstructed by adjoining buildings, trees, sign boards or other obstructions or by partitions inside in the path of air flow.
- 5) Greatest flow per unit area of openings is obtained by using inlet and outlet openings of nearby equal areas at the same level.
- 6) For a total area of openings (inlet and outlet) of 20% to 30% of floor area, the average indoor wind velocity is around 30% of outdoor velocity. Further increase in window size increases the available velocity but not in the same proportion. In fact, even under most favorable conditions the maximum average indoor wind speed does not exceed 40% of outdoor velocity.
- 7) Where the direction of wind is quite constant and dependable, the size of the inlet should be kept within 30 to 50% of the total area of openings and the building should be oriented perpendicular to the incident wind. Where direction of the wind is quite variable, the openings may be arranged so that as far as possible there is approximately equal area on all sides. Thus no matter what the wind direction is, there would be some openings directly exposed to wind pressure and others to air suction and effective air movement through the building would be assured.

- 8) Where the direction of wind is quite constant and dependable, the size of the inlet should be kept within 30 to 50% of the total area of openings and the building should be oriented perpendicular to the incident wind. Where direction of the wind is quite variable, the openings may be arranged so that as far as possible there is approximately equal area on all sides. Thus no matter what the wind direction is, there would be some openings directly exposed to wind pressure and others to air suction and effective air movement through the building would be assured.
- 9) In rooms of normal size having identical windows on opposite walls the average indoor air speed increases rapidly by increasing the width of the window up to two-thirds of the wall width; beyond that the increase is in much smaller proportion than the increase of the window width. The air motion in the working zone is maximum when window height is 1.1 m. Further increase in window height promotes air motion at higher level of window, but does not contribute additional benefits as regards air motion in the occupancy zones in buildings.
- 10) Windows of living rooms should open directly to an open space. In places where building sites are restricted, open space may have to be created in the buildings by providing adequate courtyards.
- 11) In the case of rooms with only one wall exposed to outside, provision of two windows on that wall is preferred to that of a single window.
- 12) Windows located diagonally opposite to each other with the windward window near the upstream corner give better performance than other window arrangements for most of the building orientations.
- 13) Horizontal louvers, that is a sunshade, atop a window deflects the incident wind upward and reduces air motion in the zone of occupancy. A horizontal slot between the wall and horizontal louver prevents upward deflection of air in the interior of rooms. Provision of inverted L type (r) louver increases the room air motion provided that the vertical projection does not obstruct the incident wind.
- 14) Provision of horizontal sashes inclined at an angle of 45° in appropriate direction helps to promote the indoor air motion. Sashes projecting outward are more effective than projecting inward.
- 15) Air motion at working plane 0.4 m above the floor can be enhanced by 30% using a pelmet type wind deflector.
- 16) Roof overhangs help by promoting air motion in the working zone inside buildings.

- 17) In case of room with windows on one wall, with single window, the room wind velocity inside the room on the windward side is 10% of outdoor velocity at points up to a distance of one-sixth of room width from the window and then decreases rapidly and hardly any air movement is produced in the leeward half portion of the room. The average indoor wind velocity is generally less than 10% of outdoor velocity. When two windows are provided and wind impinges obliquely on them, the inside velocity increases up to 15% of the outdoor velocity.
- 18) Cross ventilation can be obtained through one side of the building to the other, in case of narrow buildings with the width common in the multi-storeyed type by the provision of large and suitably placed windows or combination of windows and wall ventilators for the inflow and outflow of air.
- 19) Verandah open on three sides is to be preferred since it causes an increase in the room air motion for most of the orientations of the building with respect to the outdoor wind.
- 20) A partition placed parallel to the incident wind has little influence on the pattern of the air flow, but when located perpendicular to the main flow, the same partition creates a wind shadow. Provision of a partition with spacing of 0.3 m underneath helps by augmenting air motion near floor level in the leeward compartment of wide span buildings.
- 20) Air motion in a building unit having windows tangential to the incident wind is accelerated when unit is located at end-on position on downstream side.
- 21) Air motion in two wings oriented parallel to the prevailing breeze is promoted by connecting them with a block on downstream side.
- 22) Air motion in a building is not affected by constructing another building of equal or smaller height on the leeward side; but it is slightly reduced if the leeward building is taller than the windward block.
- 23) Air motion in a shielded building is less than that in an unobstructed building. To minimize the shielding effect, the distances between two rows should be 8H for semi-detached houses and 10H for long rows houses. However, for smaller spacing the shielding effect is also diminished by raising the height of the shielded building.
- 24) Hedges and shrubs deflect the air away from the inlet openings and cause a reduction in indoor air motion. These elements should not be planted at a distance of about 8m from the building because the induced air motion is reduced to minimum in that case. However, air motion in the leeward part of the building can be enhanced by planting a low hedge at a distance of 2m from the building.
- 25) Trees with large foliage mass having trunk bare of branches up to the top level of window, deflect the outdoor wind downwards and promotes air motion in the leeward portion of buildings.
- 26) Ventilation conditions indoors can be ameliorated by constructing buildings on earth mound having a slant surface with a slope of 10° on the upstream side.

- 28) In case of industrial buildings, the window height should be about 1.6m and the width about two thirds of wall width. These should be located at a height of 1.1m above the floor. In addition, openings around 0.9m high should be provided over two-thirds of the length of the glazed area in the roof lights.
- 29) Height of industrial buildings, although determined by the requirements of industrial processes involved, generally kept large enough to protect the workers against hot stagnant air below the ceiling as also to dilute the concentration of contaminant inside. However, if high level openings in roof or walls are provided, building height can be reduced to 4m without in any way impairing the ventilation performance.
- 30) The maximum width up to which buildings of height usually found in factories, being effectively ventilated by natural means by wind action, is 30m, beyond which sufficient reliance cannot be placed on prevailing winds. Approximately half the ventilating area of openings should be between floor level and a height of 2.25m from the floor.

By Stack Effect

Natural ventilation by stack effect occurs when air inside a building is at a different temperature than air outside. Thus, in heated buildings or in buildings wherein hot processes are carried out and in ordinary buildings during summer nights and during pre-monsoon periods, when the inside temperature is higher than that of outside, cool outside air will tend to enter through openings at low level and warm air will tend to leave through openings at high level. It would, therefore, be advantageous to provide ventilators as close to ceilings as possible. Ventilators can also be provided in roofs as, for example, cowl, ventpipe, covered roof and ridge vent.

Design guidelines for ceiling fans

5.7 Energy Conservation in Ventilation System

5.7.1.1 Adequate number of circulating fans should be installed to serve all interior working areas during summer months in the hot dry and warm humid regions to provide necessary air movement at times when ventilation due to wind action alone does not afford sufficient relief.

5.7.1.1.1 The capacity of a ceiling fan to meet the requirement of a room with the longer dimension D metre should be about $55D$ m³/min.

5.7.1.1.2 The height of fan blades above the floor should be $(3H + W)/4$, where H is the height of the room, and W is the height of work plane.

5.7.1.1.3 The minimum distance between fan blades and the ceiling should be about 0.3m.

5.7.2 Electronic regulators should be used instead of resistance type regulators for controlling the speed of fans.

5.7.3 When actual ventilated zone does not cover the entire room area, then optimum size of ceiling fan should be chosen based on the actual usable area of room, rather than the total floor area of the room. Thus smaller size of fan can be employed and energy saving could be achieved.

5.7.4 Power consumption by larger fans is obviously higher, but their power consumption per square metre of floor area is less and service value higher. Evidently, improper use of fans irrespective of the rooms' dimensions is likely to result in higher power consumption. From the point of view of energy consumption, the number of fans and the optimum sizes for rooms of different dimensions are given in Table 5-2-1

Table 5-2-1 Optimum Size/Number of Fans for Rooms of Different Sizes

Room width m (1)	Room length					
	4m (2)	5m (3)	6m (4)	7m (5)	8m (6)	9m (7)
3	1200/1	1400/1	1500/1	1050/2	1200/2	1400/2
4	1200/1	1400/1	1200/2	1200/2	1200/2	1400/2
5	1400/1	1400/1	1400/2	1400/2	1400/2	1400/2
6	1200/2	1400/2	900/4	1050/4	1200/4	1400/4
7	1200/2	1400/2	1050/4	1050/4	1200/4	1400/4
8	1200/2	1400/2	1200/4	1200/4	1200/4	1400/4
9	1400/2	1400/2	1400/4	1400/4	1400/4	1400/4
10	1400/2	1400/2	1400/4	1400/4	1400/4	1400/4
11	1500/2	1500/2	1500/4	1500/4	1500/4	1500/4
12	1200/3	1400/3	1200/6	1200/6	1200/6	1400/6
13	1400/3	1400/3	1200/6	1200/6	1200/6	1400/6
14	1400/3	1400/3	1400/6	1400/6	1400/6	1400/6

Room width m (1)	Room length				
	10m (8)	11m (9)	12m (10)	14m (11)	16m (12)
3	1400/2	1400/2	1200/3	1400/3	1400/3
4	1400/2	1500/2	1200/3	1400/3	1500/3
5	1400/2	1500/2	1400/3	1400/3	1500/3
6	1400/4	1500/4	1200/6	1400/6	1500/6
7	1400/4	1500/4	1200/6	1400/6	1500/6
8	1400/4	1500/4	1200/6	1400/6	1500/6
9	1400/4	1500/4	1400/6	1400/6	1500/6
10	1400/4	1500/4	1400/6	1400/6	1500/6
11	1500/4	1500/4	1500/6	1500/6	1500/6
12	1400/6	1500/6	1200n	1400/9	1400/9
13	1400/6	1500/6	1400/9	1400/9	1500/9
14	1400/6	1500/6	1400/9	1400/9	1500/9

NOTE: For data on outdoor wind speeds at a place, reference may be made to 'The Climatic Data Handbook' prepared by Central Building Research Institute, Roorkee, 1999

5.2.1.2 Mechanical Ventilation Air Quantity Design Requirements

Mechanical ventilation is a standard part of air conditioning in large commercial buildings which have a central air conditioning plant. Usually about 10% of the circulated air for cooling will be outdoor air; commonly referred as *fresh air*. Designers need to size the systems such that there is a balance between the outdoor air supplied and the amount which is removed by exhaust fans.

Smaller buildings that might have split air conditioning systems need to rely on windows for outdoor air. Similar situation exists for smaller leased out spaces within large buildings where the tenant would typically install split air conditioning systems for better indoor air quality.

Whereas in mixed mode buildings, the fresh air intake through natural ventilation is intentional by design. In this case, the HVAC system, with the help of sensors and building automation system will modulate the exterior fenestrations to allow outdoor air directly in the building when the outdoor conditions are comfortable. As per the Code,

[Buildings that are ventilated using a mechanical ventilation system or spaces in mixed-mode ventilated buildings that are ventilated with a mechanical system, either completely or in conjunction with natural ventilation systems, shall:](#)

- [\(a\) Install mechanical systems that provide outdoor air change rate as per NBC.](#)
- [\(b\) Have a ventilation system controlled by CO sensors for basement carpark spaces with total car park space greater than or equal to 600 m².](#)

Basements in commercial buildings are typically used for vehicle parking and usually poorly ventilated. Carbon monoxide (CO) and nitrous

oxide (NO₂) are the two most abundant airborne pollutants found in basement parking structure posing health and safety concerns. Ventilation is essential to prevent the concentration of these pollutants reaching an unsafe level. The CO sensors help keep these levels in check by modulating the exhaust fans or the ventilation system through the building automation system. Further ventilation also helps remove the toxic oil and gasoline fumes given off vehicle exhausts.

Use of CO sensors is an energy conserving strategy where the ventilation fans will supply outdoor air as per the requirement to dilute the carbon monoxide concentrations for keeping it at safe levels. Thus, the fans do not need to be operating at full capacity all the time.

5.2.1.3 Demand Control Ventilation

Spaces with variable and high occupant densities such as theatres, meeting rooms, auditorium and others are seldom occupied at full capacity and hence can save energy by providing demand-controlled ventilation (DCV). Such system modulates the amount of outdoor air as per the number of people present in the space and hence save energy. A common indicator of occupancy is CO₂ concentration which increases with the number of people and also depends on their activity level. The DCV must maintain the outdoor air change rates as per the NBC

As per the Code,

[Mechanical ventilation systems shall have demand control ventilation if they provide outdoor air greater than 1,500 liters per second, to a space greater than 50m², with occupant density exceeding 40 people per 100 m² of the space, and are served by one or more of the following systems:](#)

- [\(a\) An air side economizer](#)
- [\(b\) Automatic outdoor modulating control of the outdoor air damper](#)

It is important to locate the CO₂ sensors properly to get the maximum benefit. Few design guidelines are given below:

1. The sensors should be installed in all the densely occupied spaces
2. It should be installed at a height of 1.5m from the floor which is considered as the breathing zone
3. The CO₂ monitoring system should be configured to generate an audible or visual alarm to the system operator if the differential CO₂ concentration exceeds the setpoint by more than 10%.

Exceptions to § 5.2.1.3: Following shall be exempt from installing demand control ventilation systems:

(a) Classrooms in Schools, call centers category under Business

(b) Spaces that have processes or operations that generate dust, fumes, mists, vapors, or gases and are provided with exhaust ventilation, such as indoor operation of internal combustion engines or areas designated for unvented food service preparation, or beauty salons

(c) Systems with exhaust air energy recovering system

5.2.2 Minimum Space Conditioning Equipment Efficiencies

Today air conditioning is a common sight in commercial buildings. In a hot climate like India, space cooling is required for most of the year. In addition to providing cooling, the HVAC systems control humidity and ventilation. There are many different types of HVAC systems suited for different purposes. After deciding the right type of system for the project, it is important to select high efficient model also. There are many terms used to communicate the efficiency of systems as explained below.

Energy Efficiency Terms

Coefficient of Performance (COP) – Cooling

The ratio of the rate of heat removal to the rate of energy input, in consistent units, for a complete refrigerating system or some specific portion of that system under designated operating conditions.

Coefficient of Performance (COP) – Heating

The ratio of the rate of heat delivered to the rate of energy input, in consistent units, for a complete heat pump system, including the compressor and, if applicable, auxiliary heat, under designated operating conditions.

Energy Efficiency Ratio (EER)

The ratio of net cooling capacity in BTU/hr to total rate of electric input in watts under designated operating conditions.

Integrated Part-Load Value (IPLV)

A single number figure of merit based on part-load EER, COP, or KW/ton expressing part-load efficiency for air-conditioning and heat pump equipment on the basis of weighted operation at various capacities for the equipment

Selection of individual equipment efficiency should be considered in the context of the whole HVAC system. In a chilled-water system, for example, although the chiller is at the core of the system and typically is the single largest energy user, simply selecting a high-efficiency chiller does not guarantee high performance. Auxiliary equipment (such as fans and blowers) and design decisions (such as “approach temperatures”) can have substantial effects on overall efficiency. Thus, attention to overall system design and auxiliary components is critical to achieving optimal performance and comfort. Even in packaged air-conditioning systems, leaky

ductwork, improper sizing, refrigerant charge, and air flow rates can considerably affect energy performance.

5.2.2.1 Chillers

Chillers shall meet or exceed the minimum efficiency requirements presented in Table 5-1 through Table 5-2 under ANSI/ AHRI 550/ 590 conditions.

(b) The application of air-cooled chiller is allowed in all buildings with cooling load less than 530 kW. For buildings with cooling load equal to or greater than 530 kW, the number of air-cooled chiller shall be restricted to 33% of the total installed chilled water capacity unless the authority having jurisdiction mandates the application of air cooled chillers.

(c) Minimum efficiency requirements under BEE Standards and Labeling Program for chillers shall take precedence over the minimum requirements presented Table 5-1 through Table 5-2.

(d) To show compliance to ECBC, minimum requirement of both COP and IPLV requirement of ECBC Building shall be met. To show compliance with ECBC+ Building and SuperECBC Building, minimum requirement of either COP or IPLV of respective efficiency level shall be met.

Table 5-1 Minimum Energy Efficiency Requirements for water cooled Chillers

Chiller Capacity (kW _r)	ECBC Building	
	COP	IPLV
<260	4.7	5.8
≥260 & <530	4.9	5.9
≥530 & <1,050	5.4	6.5
≥1,050 & <1,580	5.8	6.8
≥1,580	6.3	7.0

Table 5-2 Minimum Energy Efficiency Requirements for air cooled Chillers

Chiller Capacity (kW _r)	ECBC Building	
	COP	IPLV
<260	2.8	3.5
≥260	3.0	3.7

5.2.2.2 Unitary, Split, Packaged Air-Conditioners

Unitary air-conditioners shall meet or exceed the efficiency requirements given in Table 5-3 through **Error! Reference source not found.** Window and split air conditioners shall be certified under BEE’s Star Labeling Program. EER shall be as per IS 8148 for all unitary, split, packaged air conditioners greater than 10 kW_r.

Table 5-3 Minimum Requirements for Unitary, Split, Packaged Air Conditioners in ECBC Building

Cooling Capacity (kW _r)	Water Cooled	Air Cooled
≤ 10.5	NA	BEE 3 Star
> 10.5	3.3 EER	2.8 EER

5.2.2.3 Variable Refrigerant Flow

Variable Refrigerant Flow (VRF) systems shall meet or exceed the efficiency requirements specified in

Table 5-4 as per the ANSI/AHRI Standard 1230 while the Indian Standard on VRF is being developed. BEE Standards and Labeling requirements for VRF shall take precedence over the current minimum requirement

Table 5-4 Minimum Efficiency Requirements for VRF Air conditioners for ECBC Building*

Type	Size category (kW _r)	For Heating or cooling or both	
		EER	IEER
VRF Air Conditioners, Air cooled	< 40	3.28	4.36
	>= 40 and < 70	3.26	4.34
	>= 70	3.02	4.07

* The revised EER and IEER values as per Indian Standard for VRF corresponding to values in this table will supersede as and when the revised standards are published.

5.2.2.4 Air Conditioning and Condensing Units Serving Computer Rooms

Computer rooms or server rooms in commercial buildings tend to have a dedicated air conditioning system with different temperature control requirements for the equipment operation rather than occupant comfort. These

systems are typically operational for 24 hours and hence use significant amount of energy. As per the Code,

Air conditioning and condensing units serving computer rooms shall meet or exceed the energy efficiency requirements listed in Table 5-5.

Table 5-5 Minimum Efficiency Requirements for Computer Room Air Conditioners

Equipment type	Net Sensible Cooling Capacity ^a	Minimum SCOP-127 ^b	
		Downflow	Upflow
All types of computer room ACs Air/ Water/ Glycol	All capacity	2.5	2.5

a. Net Sensible cooling capacity = Total gross cooling capacity - latent cooling capacity – Fan power

b. Sensible Coefficient of Performance (SCOP-127): A ratio calculated by dividing the net sensible cooling capacity in watts by the total power input in watts (excluding reheater and dehumidifier) at conditions defined in ASHRAE Standard 127-2012 Method of Testing for Rating Computer and Data Processing Room Unitary Air Conditioners)

5.2.2.5 Boilers

Boilers are used for heating water to supply hot water or heat to a building. The heat is supplied by the combustion of a fuel; usually oil or gas. Major heat loss in a boiler occurs because of the creation of water vapour from burning hydrogen content of fuel. This enthalpy – or heat content in the form of latent heat of vaporization escapes the system resulting in loss of energy.

The Fuel Utilization Efficiency (FUE) is a unit that measures boiler’s efficiency of converting fuel to energy. A higher FUE means higher energy efficiency.

As per the Code,

Gas and oil-fired boilers shall meet or exceed the minimum efficiency requirements specified in

A condensing boiler recovers heat from the waste gas by condensing water vapour to liquid water thereby achieving higher energy efficiency. The condensed vapor leaves the system in a liquid form via a drain.

DRAFT

Table 5-6 Minimum Efficiency Requirements for Oil and Gas Fired Boilers for ECBC building

Equipment Type	Sub Category	Size Category	Minimum FUE
Boilers, Hot Water	Gas or oil fired	All capacity	80%

FUE - fuel utilization efficiency

5.2.3 Controls

Controls are one of the most critical elements for improving efficiency of any HVAC system. Controls determine how HVAC systems should operate to meet the design goals of comfort, efficiency, and cost-effective operation. In this context, the Code specifies the use of time clocks, temperature controls/thermostats, and two-speed or variable speed drives for fans.

5.2.3.1 Time clock

Mechanical cooling and heating systems in Universities and Training Institutions of all sizes and all Shopping Complexes with built up area greater than 20,000 m² shall be controlled by timeclocks that:

- (a) Can start and stop the system under different schedules for three different day-types per week,
- (b) Are capable of retaining programming and time setting during loss of power for a period of at least 10 hours, and
- (c) Include an accessible manual override that allows temporary operation of the system for up to 2 hours.

Exceptions to §5.2.3.5:

- (a) Cooling systems less than 17.5 kW_r
- (b) Heating systems less than 5.0 kW_r
- (c) Unitary systems of all capacities

5.2.3.2 Temperature Controls

Mechanical heating and cooling equipment in all buildings shall be installed with controls to manage the temperature inside the conditioned zones. Each floor or a building block shall be installed with at least one control to manage the temperature. These controls should meet the following requirements:

- (a) Where a unit provides both heating and cooling, controls shall be capable of providing a temperature dead band of 3.0°C within which the supply of heating and cooling energy to the zone is shut off or reduced to a minimum.
- (b) Where separate heating and cooling equipment serve the same temperature zone, temperature controls shall be interlocked to prevent simultaneous heating and cooling.
- (c) Separate thermostat control shall be installed in each
 - i. guest room of Resort and Star Hotel,
 - ii. room less than 30 m² in Business,
 - iii. air-conditioned class room, lecture room, and computer room of Educational,
 - iv. in-patient and out-patient room of Healthcare

5.2.3.3 Occupancy Controls

Occupancy controls shall be installed to de-energize or to throttle to minimum the ventilation and/or air conditioning systems when there are no occupants in:

- (a) Each guest room in a Resort and Star Hotel
- (b) Each public toilet in a Star Hotel or Business with built up area more than 20,000 m²

(c) Each conference and meeting room in a Star Hotel or Business

(d) Each room of size more than 30 m² in Educational buildings

5.2.3.4 Fan Controls

Through the application of variable speed drive (VSD) on the cooling tower fan, the fan speed can be reduced during lower ambient conditions for reducing energy consumption.

Variable Speed Drive

A variable speed drive (VSD) is an electronic device that controls the rotational speed of a piece of motor-driven equipment (e.g. a blower, compressor, fan, or pump). Speed control is obtained by adjusting the frequency of the voltage applied to the motor. This approach usually saves energy for varying-load applications.

However condenser water reset strategy may require condenser fan speeds to be maintained to improve chiller efficiency by lowering condenser water temperature. At lower loads the overall system efficiency should be the driver as pumping and tower fan energy form significant proportion of overall chiller plant energy.

Cooling towers in buildings with built up area greater than 20,000 m², shall have fan controls based on wet bulb logic, with either:

(a) Two speed motors, pony motors, or variable speed drives controlling the fans, or

(b) Controls capable of reducing the fan speed to at least two third of installed fan power

5.2.3.5 Dampers

Dampers are devices that regulate the air flow in a air handling system. The unwanted hot or cold air from outside can be prevented from entering the building by controlling the dampers.

All air supply and exhaust equipment, having a Variable Frequency Drive (VFD), shall have dampers that automatically close upon:

(a) Fan shutdown, or,

(b) When spaces served are not in use

(c) Backdraft gravity damper is acceptable in the system with design outdoor air of the system is less than 150 liters per second in all climatic zones except cold climate, provided backdraft dampers for ventilation air intakes are protected from direct exposure to wind.

(d) Dampers are not required in ventilation or exhaust systems serving naturally conditioned spaces.

Dampers are not required in exhaust systems serving kitchen exhaust hoods.

5.2.4 Piping and Ductwork

5.2.4.1 Piping Insulation

Chilled water and hot water are carried through a network of pipes to various components of the heating, cooling and service hot water equipment in the building. During this transport, heat loss should be minimized to conserve energy. Hence the Code requires insulation for piping as per Table 5-7 through

Table 5-9. Since the rate of heat transfer also depends on the temperature of water in the pipes, the Code specifies higher insulation levels for water at higher temperatures. In the case of a ductless system, Code specifies insulation values for the refrigerant piping.



Figure 5.8 Chilled water pipe insulation installation

Further, insulation that is exposed to weather and subject to damage must be protected. For example, insulation located outdoors may be subject to damage from sunlight, rain, moisture, wind.

As per the Code,

Piping for heating, space conditioning, and service hot water systems shall meet the insulation requirements listed in Table 5-7 through Table 5-9. Insulation exposed to weather shall be protected by aluminum sheet metal, painted canvas, or plastic cover. Cellular foam insulation shall be protected as above, or be painted with water retardant paint.

Exceptions to § 5.2.4.1:

- (a) Reduction in insulation R value by 0.2 (compared to values in Table 5-7, Table 5-8 and Table 5-9) to a minimum insulation level of R-0.4 shall be permitted for any pipe located in partition within a conditioned space or buried.
- (b) Insulation R value shall be increased by 0.2 over and above the requirement stated in Table 5-7 through Table 5-9 for any pipe

located in a partition outside a building with direct exposure to weather.

- (c) Reduction in insulation R value by 0.2 (compared to values in Table 5-7, Table 5-8 and Table 5-9) to a minimum insulation level of R-0.4 shall be permitted for buildings in Temperate climate zone.

Table 5-7 Insulation Requirements for Pipes in ECBC Building

Operating Temperature (°C)	Pipe size (mm)	
	<40	>=40
	Insulation R value (m ² .K/W)	
<i>Heating System</i>		
>94°C and <=121°C	0.9	1.2
>60°C and <=94°C	0.7	0.7
>40°C and <=60°C	0.4	0.7
<i>Cooling System</i>		
>4.5°C and <=15°C	0.4	0.7
< 4.5°C	0.9	1.2
<i>Refrigerant Piping (Split systems)</i>		
>4.5°C and <=15°C	0.4	0.7
< 4.5°C	0.9	1.2

Minimizing heat loss is important for energy conservation. For piping that can easily run into several metres in buildings, insulation requirements are progressively stringent for ECBC+ and Super ECBC buildings.

Table 5-8 Insulation Requirements for Pipes in ECBC+ Building

Operating Temperature (°C)	Pipe size (mm)	
	< 40	>=40
	Insulation R value (m ² .K/W)	
<i>Heating System</i>		
>94°C and <=121°C	1.1	1.3
>60°C and <=94°C	0.8	0.8
>40°C and <=60°C	0.5	0.9
<i>Cooling System</i>		
>4.5°C and <=15°C	0.5	0.9
< 4.5°C	1.1	1.3
<i>Refrigerant Piping (Split systems)</i>		
>4.5°C and <=15°C	0.5	0.9
< 4.5°C	1.1	1.3

Table 5-9 Insulation Requirements for Pipes in SuperECBC Buildings

Operating Temperature (°C)	Pipe size (mm)	
	< 40	>=40
	Insulation R value (m ² .K/W)	
<i>Heating System</i>		
>94°C to <=121°C	1.5	1.5
>60°C to <=94°C	1.0	1.3
>40°C to <=60°C	0.7	1.1
<i>Cooling System</i>		
>4.5°C to <=15°C	0.7	1.2
< 4.5°C	1.5	1.5
<i>Refrigerant Piping (Split Systems)</i>		
>4.5°C to <=15°C	0.7	1.1
< 4.5°C	1.5	1.5

5.2.4.2 Ductwork and Plenum Insulation

Air is supplied to rooms/spaces by means of round or rectangular ducts. Supply ducts carry the conditioned air to be supplied to the space and return ducts carry the air from the space back to the air conditioning system. Ducts are constructed out of thin sheet metal which are highly conductive.



Figure 5.9 Ductwork in a mechanical room

Typically supply ducts carry cool air and hence it is critical to thermally insulate the ducts to prevent heat loss. Whereas the return ducts

carry relatively warm air and hence heat loss is not a great concern as long as the duct is installed inside the building. The Code requires return ducts to be insulated only when exposed to outdoor air.



Figure 5.10 Insulated ducts

Sometimes, the empty space above the dropped ceiling can be used to carry the return air instead of installing a separate return duct. This is called a plenum. As per the Code, the requirements for return ducts is applicable to the plenum space. Table 5-10 shows the Code requirement for applicable insulation.

Table 5-10 Ductwork Insulation (R value in m². K/W) Requirements

Duct Location	Supply ducts	Return ducts
Exterior	R -1.4	R -0.6
Unconditioned Space	R -0.6	None
Buried	R -0.6	None

Table 5 A provides R-value (h. °F .ft²)/Btu of a few insulating materials.

Table 5 A Sample R-values for Duct Insulation Materials

Installed R-value ¹ (m ² :K/W)	Typical Material Meeting or Exceeding the Given R-value ²
1.9	½ in. Mineral fiber duct liner per ASTM C 1071, Type 1 1 in. Mineral fiber duct wrap per ASTM C 1290
3.5	1 in. Mineral fiber duct liner per ASTM C 1071, Types I & II 1 in. Mineral fiber board per ASTM C 612, Types IA & IB 1 in. Mineral fiber duct board per UL 181 1 ½ in. Mineral fiber duct wrap per ASTM C 1290 1 in. Insulated flex duct per UL 181
6.0	1 ½ in. Mineral fiber duct liner per ASTM C1071, Types I & II 1 ½ in. Mineral fiber duct board per UL 181 1 ½ in. Mineral fiber board per ASTM C 612, Types IA & IB 2 in.. 2 lb/ft ³ Mineral fiber duct wrap per ASTM C 1290 2 ½ in. 0.6 to 1 lb./ft ³ Mineral fiber duct wrap per ASTM C 1290 2 ½ in. Insulated flex duct per UL 181
8.0	2 in. Mineral fiber duct liner per ASTM C 1071, Types I & II 2 in. Mineral fiber duct board per UL 181 2 in. Mineral fiber board per ASTM C 612, Types IA & IB 3 in. ¾ lb/ft ³ Mineral fiber duct wrap insulation per ASTM C 1290 3 in. Insulated flex duct per UL 181
10.0	2 ½ in. Mineral fiber board per ASTM C 612, Types IA & IB
1) Listed R-values are for the insulation only as determined in accordance with ASTM C 518 at a mean temperature of 24°C at the installed thickness and do not include air film resistance. 2) Consult with manufacturers for other materials or combinations of insulation thickness or density meeting the required R-value.	

Source: ASHRAE 90.1 User Manual (2007), Table 6-D

Duct sealing

Ensuring proper design, construction and sealing of duct joints is an essential aspect of energy conservation. Ductwork should be properly air sealed and also be protected from moisture absorption. Condensing moisture can cause many types of insulation, such as fiberglass, to lose their insulating properties or degrade. Duct sealing is critical to avoid air leaks that prevent the HVAC system from functioning as designed and operated. The Code currently does not

provide any guidance on ductwork sealing. The ASHRAE 90.1 energy code can be referred to for appropriate seal levels for all ductwork in order to minimize energy losses from the HVAC system. ASHRAE 90.1 (tables 6.2.4.3 A and 6.2.4.3 B) specify sealing requirements based on the duct location, static pressure classification, and type of the duct (exhaust or return) as given below in Table 5 B.

Table 5 B Requirements for duct sealing

Minimum Duct Seal Level				
Duct Location	Duct Type Supply		Exhaust	Return
	≤498.2 Pa	≥498.2 Pa		
Outdoors	A	A	C	A
Unconditioned Spaces	B	A	C	B
	C	B	B	C

Source: ASHRAE 90.1 Table 6.2.4.3 A

Duct Seal Levels	
Seal Level	Sealing Requirements
A	All transverse joints and longitudinal seams, and duct wall penetrations. Pressure-sensitive tape shall not be used as the primary sealant.
B	All transverse joints and longitudinal seams. Pressure-sensitive tape shall not be used as the primary sealant
C	Transverse joints only.

Source: ASHRAE 90.1 Table 6.2.4.3 B

Guidelines for good duct design and construction is given in the Box 5-2 below.

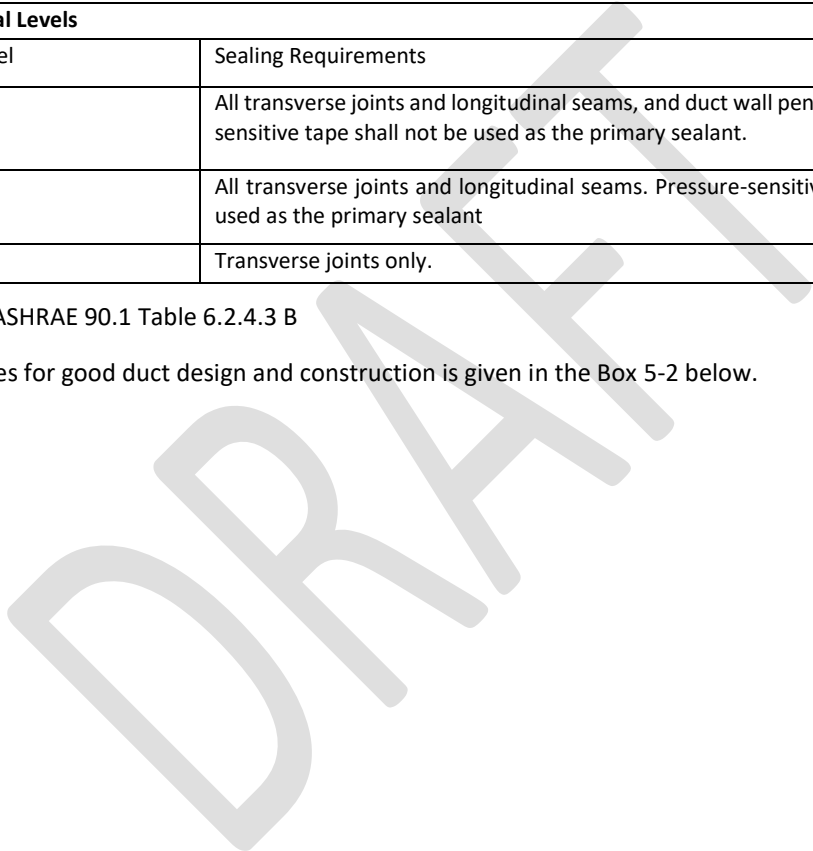

BOX 5-2 Design guidelines for good ductwork

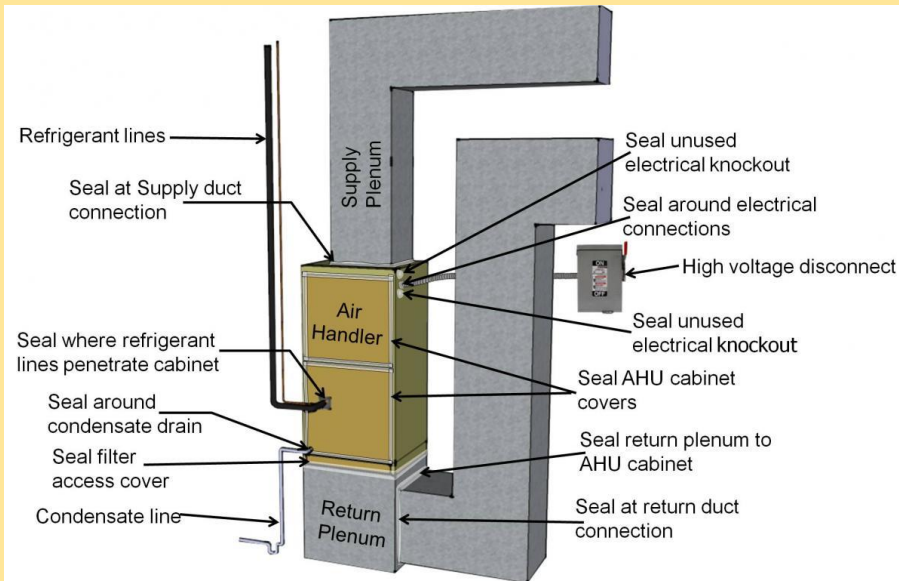

- Design a compact duct layout with short straight runs and minimal bends.
- Include ducts within conditioned space if possible. This makes the ducts easy to access for maintenance. It also protects the duct from being exposed to high temperatures and humidity (in some cases) in unconditioned spaces.
- Use screws to secure connections in the metal ducts. Wipe ducts to ensure they are clean and dry especially at seams and joints.
- Seal all seams and joints in the ducts with mastic. Cover all seams that are wider than 1/8 inch with fiberglass mesh tape then apply mastic.
- Use putty around all conduit and wiring holes.
- Consider insulating all metal ductwork located in conditioned space, including supply and return ducts, duct boots, and exhaust ducts, to minimize condensation.
- Ensure that all duct connections and seams are air sealed for the following, regardless of whether they are located in conditioned or unconditioned space:
- Ensure that insulation completely covers ducts and connections without gaps, voids, or compressions.

Source: PNNL

<https://basc.pnnl.gov/building-components/browse/180325>

5.2.5 System Balancing

5.2.5.1 General

System balancing is a process for maintaining the performance of an HVAC system, and for providing the occupants with a comfortable conditioned space and reducing the cost of operation. Balancing is achieved by optimizing the air/water distribution rates for the HVAC system.

As per the Code,

System balancing shall be done for systems serving zones with a total conditioned area exceeding 500 m².

Construction documents provide vital information to the building owners on how to properly operate and maintain a system that has been properly balanced. Verify during final inspection that an operations manual has been passed on to the building owner and that it contains the following information at a minimum.

- HVAC equipment capacity
- Equipment operation and maintenance manuals
- HVAC system control maintenance and calibration information, including wiring diagrams, schedules, and control sequence descriptions.
- A complete written narrative of how each system is intended to operate.

5.2.5.2 Air System Balancing

Air System Balancing refers to the adjustment of airflow rates through air distribution system devices, such as fans and diffusers. In a central plant system, the chilled water is supplied to the Air Handling Unit (AHU) from where the cool air supplied to all the spaces in the building. Depending on the scale and zoning, there can be several AHUs in a building. A large AHU can be located on the roof top which supplied cool air to all the zones in the building. This could work in the case of a single zone system. However, most buildings have multiple zones in which case AHUs can be installed on each floor.

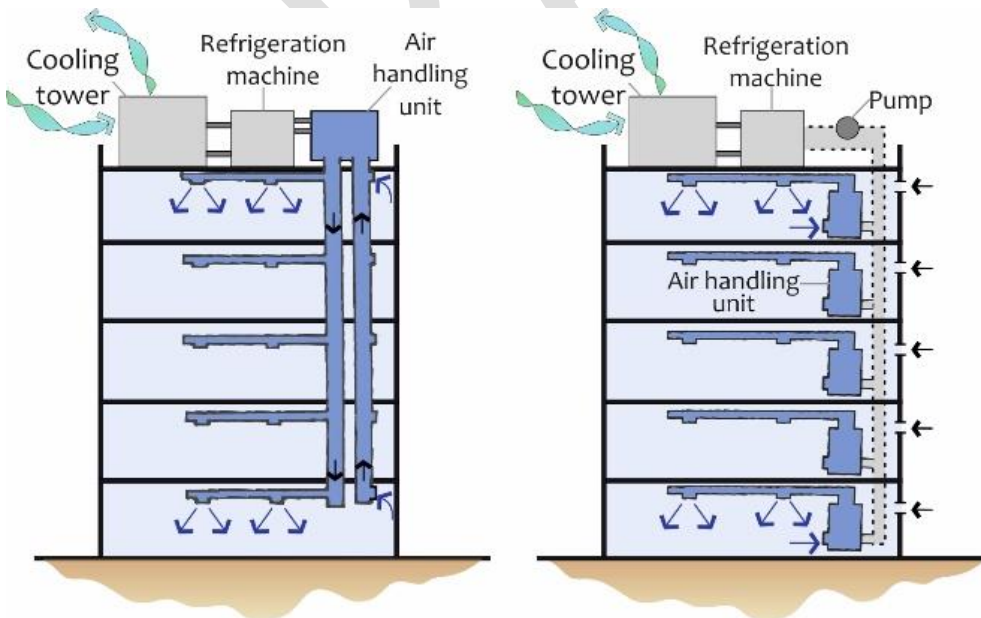

Figure 5.11 Air distribution scheme

High-efficiency air distribution systems can substantially reduce fan power required by an HVAC system, resulting in dramatic energy savings. The largest gains in efficiency for air distribution systems are realized in the system design phase for new constructions or major retrofit projects. Passive or natural air transport systems have the highest efficiency, and successful, modern examples of this approach are steadily accumulating. For buildings that require mechanical ventilation, innovative design approaches and a methodical examination of the entire air system can greatly improve efficiency and effectiveness.

Design options for improving air distribution efficiency include:

- Variable-air-volume systems
- VAV diffusers
- Low-pressure-drop duct design
- Low-face-velocity air handlers
- Fan sizing and variable-frequency-drive motors
- Displacement ventilation systems.

Air balancing is done by adjusting the position of dampers, splitter vanes, extractors, etc., manually or by using automatic control devices, such as constant air volume or variable air volume boxes.

Balancing is necessary to verify that each space served by a system receives the air volume designed for that space. Proper means for air balancing should be installed at each supply air outlet and zone terminal device. These include balancing dampers or other means of supply-air adjustment provided in the branch ducts or at each individual duct register, grille, or diffuser. Installation in the duct system of all devices used for balancing, shown on the

approved mechanical plans, typically, on the ductwork layout, should be verified.

As per the Code,

Air systems shall be balanced in a manner to first minimize throttling losses; then, for fans with fan system power greater than 0.75 kW, fan speed shall be adjusted to meet design flow conditions.

5.2.5.3 Hydronic System Balancing

Hydronic System Balancing refers to the adjustment of water flow rates through distribution system devices, such as pumps and coils, by manually adjusting the position of valves, or by using automatic control devices, such as flow control valves.

When something is balanced, it is even on both sides. Therefore, a balanced hydronic system is one that delivers even flow to all of the devices on that piping system. Each component has an effective equal length of pipe on the supply and return. And when a system is balanced, all of the pressure drops are correct for the devices. When that happens, the highest efficiencies are possible in the system. One need not have to change system supply temperatures to accommodate one zone only. The system has the least amount of pressure drop possible, which translates into reduced pumping costs.

A balanced hydronic system is one that is efficient. If a system that is not delivering the water to the right devices in the right amounts, then the system is out of balance.

As per the Code,

Hydronic systems shall be proportionately balanced in a manner to first minimize throttling losses; then the pump impeller shall be trimmed or pump speed shall be adjusted to meet design flow conditions

5.2.6 Condensers

5.2.6.1 Condenser location

A condenser is a heat exchanger that liquefies refrigerant vapor through heat removal. The typical condensing unit houses a compressor, a condenser fan motor, and coils, along with controls which make all the components work sequentially.

As per the Code,

Condensers shall be located such that the heat sink is free of interference from heat discharge by devices located in adjoining spaces, and do not interfere with other such systems installed nearby.

Condensers should be located in such a manner that there is no restriction to the air flow around the condenser coils, there is no short-circuiting of discharge air to the intake side, and the heat discharge of other adjacent equipment is not anywhere the air intake of the condenser.

Condenser water treatment is important to eliminate mineral buildup in condensers and chilled water systems. Mineral deposits create poor heat transfer situations there by reducing the efficiency of the unit.

5.2.7 Service Hot Water Heating

For some building types such as large hotels and hospitals service water heating can be major energy consumer. Inefficiency in water heating is caused primarily by inefficiency of the heating equipment, and by heat loss from hot water storage tanks and distribution piping network.

ECBC through mandatory requirements seeks to minimize energy usage in water heating systems by:

- Utilizing solar water heating
- Specifying heating equipment efficiency
- Maximizing heat recovery and minimizing electric heating
- Insulating hot water storage tanks and pipelines
- Reducing standby losses
- Reducing heat and evaporation losses in heated swimming pools

5.2.7.1 Solar Water Heating

Solar Water heaters use energy from the sun's rays to heat water for domestic & commercial purpose. This appliance consists of a collector which collects solar energy and an insulated water tank to store hot water.

The collector on receiving solar energy transfers heat to the underlying pipes containing water which in turn goes to the insulated storage tank. This water is recirculated to increase the temperature of the water.

The lifespan of a solar water heater designed as per BIS specification is between 15-20 years but a lot depends on the maintenance of the heater.

Types of solar water heaters

There are two categories of solar water heaters, namely closed loop and open loop. The closed loop system has heat exchangers for protection against hard water obtained from borewells. In the open loop system, the water is open to the atmosphere at some point in the cycle. The open loop systems are suitable for domestic as well as small industrial purposes.

Solar collectors

There are two types of solar collectors in a solar hot water system as explained below.

Flat plate collectors

It consists of a large heat absorbing plate that is dark colored to absorb solar radiation to its maximum potential. Series of thin copper tubes called risers are attached to this plate that has water circulating inside them. This assembly is enclosed in an insulated glass box.



Figure 5.12 Flat plate collector

The metal plate absorbs heat and transfers it to the copper tubes to heat the water. The glass box prevents the absorbed heat from escaping.

Evacuated tube collectors

This system consists of rows of transparent glass tubes connected to a header pipe. Since the pipes are cylindrical, the angle of sunlight is always perpendicular to the tubes which enables the collector to perform well even in low sunlight.

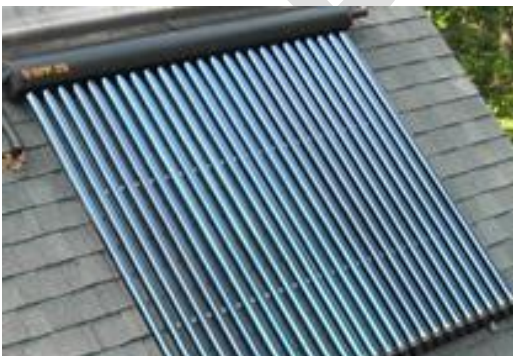

Figure 5.13 Evacuated tube collector

Each tube consists of a thick outer glass and a thin inner glass tube with a special coating that absorbs solar energy (high absorptance) but inhibits loss (low emittance). Unlike flat panel collectors, evacuated tube collectors do not heat the water directly within the tubes. Instead, air is removed or evacuated from the space between the two tubes, forming a vacuum (hence the name **evacuated tubes**).



Figure 5.14 Cross section of an evacuated tube

With the assistance of this vacuum, evacuated tube collectors generally produce higher fluid temperatures than the flat plate counterparts and hence may become very hot in summer.

As per the Code,

Hotels and Hospitals in all climatic zones and all buildings in cold climate zone with a hot water system, shall have solar water heating equipment installed to provide for:

- (a) at least 20% of the total hot water design capacity if above grade floor area of the building is less than 20,000 m²
- (b) at least 40% of the total hot water design capacity if above grade floor area of the building is greater than or equal to 20,000 m²

For compliance with ECBC+ and SuperECBC, Hotels and Hospitals in all climatic zones and all buildings in cold climate zone with a hot water system, shall have solar water heating

equipment installed to provide at least 40% and 60% respectively of the total hot water design capacity.

Exception to § 5.2.7.1: Systems that use heat recovery to provide the hot water capacity required as per the efficiency level or building size.

5.2.7.2 Heating Equipment Efficiency

As per the Code,

Service water heating equipment shall meet or exceed the performance and minimum efficiency requirements presented in available Indian Standards

- (a) Solar water heater shall meet the performance/ minimum efficiency level mentioned in IS 13129 Part (1&2)
- (b) Gas Instantaneous water heaters shall meet the performance/minimum efficiency level mentioned in IS 15558 with above 80% Fuel utilization efficiency.
- (c) Electric water heater shall meet the performance/ minimum efficiency level mentioned in IS 2082.

The mandatory requirements for the Code include minimum efficiencies presented in relevant Indian Standards for various water heating equipment such as electric and gas heaters, instantaneous heaters, boilers and pool heaters.

For Solar water heating systems, IS 13129 (Part 1) provides information on the 'Performance Rating Procedure Using Indoor Test Methods', and IS 13129 (Part 2) provides the information on the 'Procedure for System Performance Characterization and Yearly Performance Prediction'. These standards however, do not provide any performance/minimum efficiency levels.

For Gas Instantaneous Water Heaters, IS 15558 describes the information and procedure for the measurement of thermal efficiency of the heaters.

As per this Standard, thermal efficiency of the water heaters (under test conditions) shall not be less than:

- 84% for water heaters with a nominal heat input exceeding 10 kW
- 82% for water heaters with a nominal heat input not exceeding 10 kW

However, the Code specifies thermal efficiency of 80% or more.

For Electric Water Heaters, IS 2082 (Part 1) covers the safety and performance requirements of heaters with rated capacities in the range of 6 liters to 200 liters. In these heaters, certain amount of energy is consumed to keep the water hot while it is not being used. This consumption of electricity is called as standing loss (or standby loss). Standby loss depends on the design and insulation of the water heater, as well as the difference between the temperature of the water and that of the air around the tank. Water heating energy can be reduced by decreasing standby losses.

The following table of IS 2082 (Part 1) specifies the standing loss in the heaters. For hot water temperature difference of 45°C, in no case the standing loss should exceed the values specified in Table 5 C.

Table 5 C Standing Loss in Storage Type Electric Water Heaters

Rated Capacity in Liters	Loss in kWh/day for 45° Difference
6	0.792
10	0.990
15	1.138
25	1.386
35	1.584
50	1.832
70	2.079
100	2.376
140	2.673
200	2.970

Source: IS 2082 (Part 1): 1993 (Reaffirmed 2004) Edition 5.4 (2002-05) Stationary Storage Type Electric Water Heaters-Specification (Fourth Revision)

5.2.7.3 Other Water Heating System

As per the Code,

Supplementary heating system shall be designed to maximize the energy efficiency of

the system and shall incorporate the following design features in cascade:

- (a) Maximum heat recovery from hot discharge system like condensers of air conditioning units,
- (b) Use of gas fired heaters wherever gas is available, and
- (c) Electric heater as last resort.

5.2.7.4 Piping Insulation

As per the Code,

Piping insulation shall comply with § 5.2.4.1. The entire hot water system including the storage tanks, pipelines shall be insulated conforming to the relevant IS standards on materials and applications.

Box 5-3 provides guidelines for hot water temperature controls and measures for improving heating efficiency.

BOX 5-3 Guidelines for temperature controls

Water-heating systems are required to have controls that are adjustable down to a 49°C setpoint or lower. An exception is made where a higher setting is recommended by the manufacturer to prevent condensation and possible corrosion. To comply with this requirement, the water heater must have thermostatic control with an accessible setpoint. This setpoint must be adjustable down to whichever is lower: 49°C or the minimum manufacturer’s recommended setting to prevent condensation.

Both standby and distribution losses will be minimized by designing a system to provide hot water at the minimum temperature required. In addition to the potential energy savings, maintaining water temperature as low as possible reduces corrosion and scaling of water heaters and components.

Another important benefit is improved safety with respect to scalding. Accidental scalding from temperatures as low as 60°C is responsible for numerous deaths each year. Designers should be aware that the bacteria that cause Legionnaire’s Disease has been found in service water heating systems and can colonize in hot water systems maintained below 46°C.

BOX 5-2 Guidelines for temperature controls (contd)

Careful maintenance practices can reduce the risk of contamination. In health-care facilities or service-water systems maintained below 60°C, periodic flushing of the fixtures with high temperature water or other biological controls may be appropriate.

Guidelines for improving water heating system efficiency temperature controls

Reduce standby losses from storage tank and pipes.

Lower Water Heating Temperature: Use a hot water system with a thermostat. Service water heating energy use and operating costs can be reduced by simply lowering the thermostat setting on your water heater.

For each 5.5°C (10°F) reduction in water temperature, can save between 3%–5% in energy costs.

Insulate pipes and use heat traps: Insulate all exposed pipes. The R-value of pipe insulation is dependent on wall thickness; thicker is better. A 5/8" wall thickness should be considered minimum for foam insulation, while 3" is the minimum for fiberglass wrap. Heat trap nipples work best to eliminate convective losses from the tank into the plumbing, but pipe loops also work if the drop is at least 6".

Insulate the storage tank: Install a water heater insulation blanket; the higher the R-value, the better. Use wire or twine or straps to insure that the blanket stays in place. Some new high-efficiency heaters should not be insulated; consult the equipment manual provided by the manufacturer.

Gas water heaters should not be insulated on top or within about 8" of the bottom of the water tank. Set an electric water heater on a rigid foam insulation board. This step is most critical when the heater sits on a concrete slab, but it's always a good idea. Install the water heater in a heated location. The colder the air surrounding the heater, the more the standby loss. Indoor gas heaters should be sealed combustion or fan-forced draft.

5.2.7.5 Heat Traps

Heat traps are valves or loops of pipe that allow water to flow into the water heater tank but prevent unwanted hot-water flow out of the tank. The valves have balls inside that either float or sink into a seat, which stop natural water circulation loop. Heat traps can help save energy and cost on the water heating bill by preventing convective heat losses through the inlet and outlet pipes. These specially designed valves come in pairs. The valves are designed differently for use in either the hot or cold water line.

As per the Code,

Vertical pipe risers serving storage water heaters and storage tanks not having integral heat traps and serving a non-recirculating system shall have heat traps on both the inlet and outlet piping.

Heat traps may either be installed internally by the manufacturer, installed as an after-market add-on, or site fabricated. Site fabricated heat traps may be constructed by creating a loop or inverted U-shaped arrangement to the inlet and outlet pipes.

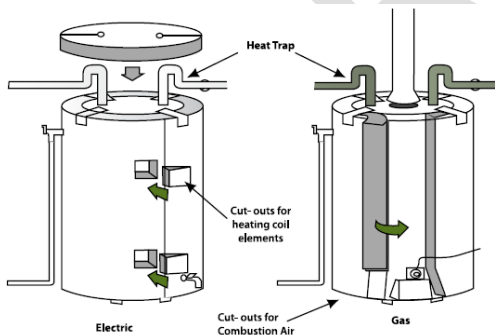

Figure 5.15 Heat trap elements

5.2.7.6 Swimming Pools

Heated swimming pools can be a source of considerable heat and water loss due to

evaporation. Also, the cost of the energy required to maintain the temperature of the water in the pool at a level comfortable for swimming is a strong incentive to adopt measures which promote retention of heat in the pool and reduction in heat loss.

As per the Code,

All heated pools shall be provided with a vapor retardant pool cover on or at the water surface. Pools heated to more than 32°C shall have a pool cover with a minimum insulation value of R-4.1.

Exception to § 5.2.7.6: Pools deriving over 60% of their energy from site-recovered energy or solar energy source.

5.3 Prescriptive Requirements

As per the Code,

Compliance shall be demonstrated with the prescriptive requirements in this section. Supply, exhaust, and return or relief fans with motor power exceeding 0.37 kW shall meet or exceed the minimum energy efficiency requirements specified in

Table 5-11 through Table 5-13 except the following need not comply with the requirement

- (a) Fans in un-ducted air conditioning unit where fan efficiency has already been taken in account to calculate the efficiency standard of the comfort system.
- (b) Fans in Health Care buildings having HEPA filters.
- (c) Fans inbuilt in energy recovery systems that pre-conditions the outdoor air.

Table 5-11 Mechanical and Motor Efficiency Requirements for Fans in ECBC Buildings

System type	Fan Type	Mechanical Efficiency	Motor Efficiency (As per IS 12615)
Air-handling unit	Supply, return and exhaust	60%	IE 2

Table 5-12 Mechanical and Motor Efficiency Requirements for Fans in ECBC+ Buildings

System type	Fan Type	Mechanical Efficiency	Motor Efficiency (As per IS 12615)
Air-handling unit	Supply, return and exhaust	65%	IE 3

Table 5-13 Mechanical and Motor Efficiency Requirements for Fans in SuperECBC Buildings

System Type	Fan Type	Mechanical Efficiency	Motor Efficiency (As per IS 12615)
Air-handling unit	Supply, return and exhaust	70%	IE 4

5.3.1 Chillers

Chillers shall meet or exceed the minimum efficiency requirements for ECBC+ and SuperECBC Buildings are presented in Table 5-14 and Table 5-15 under ANSI/ AHRI 550/ 590 conditions.

Table 5-14 Minimum Energy Efficiency Requirements for water cooled Chillers

Chiller Capacity (kW _r)	ECBC+ Building		SuperECBC Building	
	COP	IPLV	COP	IPLV
<260	5.2	6.9	5.8	7.1
≥260 & <530	5.8	7.1	6.0	7.9
≥530 & <1,050	5.8	7.5	6.3	8.4
≥1,050 & <1,580	6.2	8.1	6.5	8.8
≥1,580	6.5	8.9	6.7	9.1

Table 5-15 Minimum Energy Efficiency Requirements for air cooled Chillers

Chiller Capacity (kW _r)	ECBC+ Building		SuperECBC Building
	COP	IPLV	COP/ IPLV
<260	3.0	4.0	NA
≥260	3.2	5.0	NA

5.3.2 Pumps

Chilled and condenser water pumps shall meet or exceed the minimum energy efficiency requirements specified in Table 5-16 Pump Efficiency Requirements for ECBC Building Table 5-16 through Table 5-17. Requirements for pumps in district chiller systems and hot water pumps for space heating are limited to the installed efficiency requirement of individual pump equipment only. To show compliance, calculate the total installed pump capacity in kilo watt and achieve the prescribed limits per kilo watt of refrigeration installed in the building.

Exceptions to §5.3.1: Pumps used in processes e.g. service hot water, chilled water used for refrigeration etc.

Table 5-16 Pump Efficiency Requirements for ECBC Building

Equipment	ECBC
Chilled Water Pump (Primary and Secondary)	18.2 W/ kW _r with VFD on secondary pump
Condenser Water Pump	17.7 W/ kW _r
Pump Efficiency (minimum)	70%

Table 5-17 Pump Efficiency Requirements for ECBC+ Building

Equipment	ECBC+ Building
Chilled Water Pump (Primary and Secondary)	16.9 W/ kW _r with VFD on secondary pump
Condenser Water Pump	16.5 W/ kW _r
Pump Efficiency (minimum)	75%

Table 5-18 Pump Efficiency Requirements for SuperECBC Building

Equipment	SuperECBC Building
Chilled Water Pump (Primary and Secondary)	14.9 W/ kW _r with VFD on secondary pump
Condenser Water Pump	14.6 W/ kW _r
Pump Efficiency (minimum)	85%

5.3.3 Cooling Towers

Water-based HVAC systems offer significant energy savings due to the ability of water to transport large quantities of heat over relatively long distances, more efficiently than air-based systems. Additionally, they offer advantages such as smaller equipment size and cost, along with reduced maintenance and extended life of mechanical equipment. However, for water scarce urban centers in India, the viable installation and operation of cooling towers will require balancing needs for energy efficiency and water conservation simultaneously. Air cooled chillers are a good option to conserve water, however the trade-off is that these chillers consume more energy to provide the same amount of cooling when compared to water cooled chillers with cooling towers. Some guidelines for improving energy and water

efficiency in cooling towers is discussed in Box 5-4

As per the Code,

Cooling towers shall meet or exceed the minimum efficiency requirements specified in Table 5-19. ECBC+ and SuperECBC Buildings shall have additional VFD installed in the cooling towers

Table 5-19 Cooling Tower Efficiency Requirements for ECBC, ECBC+, and SuperECBC Buildings

Equipment type	Rating Condition		Efficiency	
Open circuit cooling tower Fans	35°C	entering	water	0.017 kW/kW _r
	29°C	leaving	water	0.31 kW/L/s
	24°C WB outdoor air			

BOX 5-4 – Design guidelines for water and energy efficiency in cooling towers

Energy Efficiency Measures:

- Proper site selection and sizing of the tower can reduce fan speed, capacity, and sound and help to conserve energy
- Centrifugal fans in favor of lower energy axial fans can reduce horsepower by 50% or more for the same capacity
- Fan control through two-speed motors, pony motors, or variable speed motors can save energy as well

Water Efficiency Measures:

- An optimized bleed rate for the tower should be maintained to regulate water consumption. The evaporation rate is dependent on the load, which can vary widely and a constant bleed rate usually discharges more water than required. A properly operating conductivity meter can automatically control bleed to the proper amount required to maintain the desired tower chemistry in the system at all times.
- Contaminant induction should be minimized and a proper blow down rate should be maintained. Water treatment regimens are effective for water conservation, keeping the cooling loop cleaner, saving energy, reducing maintenance, and improving reliability of the entire cooling system.
- New technological solutions like hybrid wet-dry cooling tower designs, which combine wet and dry cooling can be adopted to reduce water use, some as much as 70% compared to conventional towers. Typically, a dry finned coil section is combined in series with an evaporative section in these units. The dry finned section handles as much of the load as possible, with the unit able to operate completely dry at reduced ambient. Both open and closed-circuit versions are available.

Source: Morrison F.: What’s up with Cooling Tower (2004). ASHRAE Journal 46 (7)

5-3.4 Boilers

Gas and oil-fired boilers shall meet or exceed the minimum efficiency requirements specified in Table

Table 5-20 Minimum Efficiency Requirements for Oil and Gas Fired Boilers for ECBC+ and SuperECBC Buildings

Equipment Type	Sub Category	Size Category	Minimum FUE
Boilers, Hot Water	Gas or oil fired	All capacity	85%

FUE - fuel utilization efficiency

5-3.5 Economizers

Economizers allow the use of outdoor air to cool the building when the outside temperature is cooler than that inside. An economizer consists of dampers, sensors, actuators, and logic devices that together decide how much outside air to bring into a building. Under the right conditions, sensors and controls shut down the compressor and bring in the outside air through the economizer louvers. A properly operating economizer can cut energy costs by as much as 10% of a building's total energy consumption, depending mostly on local climate and internal cooling loads.

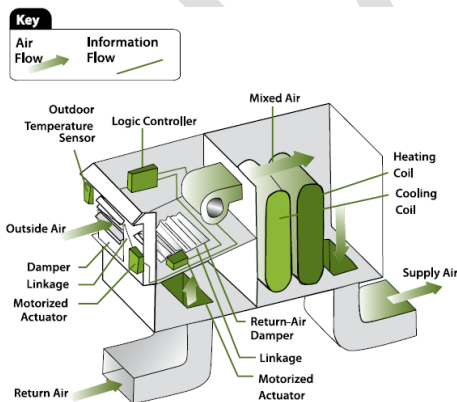

Figure 5.16 Economizer

There are primarily two types of Economizers as explained below.

Air Economizer

An air economizer is duct and damper arrangement and automatic control system that together allow a cooling system to supply outdoor air to reduce or eliminate the need for mechanical cooling during mild or cold weather.

Water Economizer

A water economizer is a system by which the supply air of a cooling system is cooled indirectly with water that is itself cooled by heat or mass transfer to the environment without the use of mechanical cooling.

5-3.5.1 Economizer for ECBC, ECBC+ and SuperECBC building

As per the Code,

Each cooling fan system in buildings with built up area greater than 20,000 m², shall include at least one of the following:

- (a) An air economizer capable of modulating outside-air and return-air dampers to supply 50% of the design supply air quantity as outside-air.
- (b) A water economizer capable of providing 50% of the expected system cooling load at outside air temperatures of 10°C dry-bulb/7.2°C wet-bulb and below.

Exception to § 5.3.5.1:

- (a) Projects in warm-humid climate zones are exempt.
- (b) Projects with only daytime occupancy in the hot-dry are exempt.
- (c) Individual ceiling mounted fan systems is less than 3,200 liters per second exempt

5.3.5.2 Partial Cooling

One can use the building's intrinsic thermal mass to reduce peak cooling loads by circulating cool night-time air to pre-cool the building prior to daily occupancy in the cooling season. The building control system can operate ventilation fans in the economizer mode on a scheduled basis. Care should be taken to prevent excessive fan operation that would offset cooling energy savings. It is also ensured that night humidity does not preclude the use of this strategy.

As per the Code,

Where required by §5.3.5.1 economizers shall be capable of providing partial cooling even when additional mechanical cooling is required to meet the cooling load.

5.3.5.3 Economizer Controls

Air economizer shall be equipped with controls

- (a) That allows dampers to be sequenced with the mechanical cooling equipment and not be controlled by only mixed air temperature.
- (b) Capable of automatically reducing outdoor air intake to the design minimum outdoor air quantity when outdoor air intake will no longer reduce cooling energy usage.
- (c) Capable of high-limit shutoff at 24 °C dry bulb temperature.

5.3.5.4 Testing

As per the Code,

Air-side economizers shall be tested in the field following the requirements in §12 Appendix C 12 to ensure proper operation.

Exception to §5.3.5.4: Air economizers installed by the HVAC system equipment manufacturer and certified to the building department as being factory calibrated and tested per the procedures in §12.

5.3.6 Variable Flow Hydronic Systems

Fluid from the heating or cooling source is supplied to heat transfer devices, such as coils and heat exchangers, and back through the hydronic system. The Code specifies the type of equipment and capabilities in such a way as to reduce pump energy. Variable fluid flow, automatic isolation valves, and variable speed drives enable the system to operate below design flow when needed.

5.3.6.1 Variable Fluid Flow

As per the Code,

HVAC pumping systems having a total pump system power exceeding 7.5 kW shall be designed for variable fluid flow and shall be capable of reducing pump flow rates to an extent which is lesser or equal to the limit, where the limit is set by the larger of:

- (a) 50% of the design flow rate, or
- (b) the minimum flow required by the equipment manufacturer for proper operation of the chillers or boilers.

5.3.6.2 Isolation Valves

Two-way automatic isolation valves serve as a means of varying flow rate in a hydronic system.

As per the Code,

Water cooled air-conditioning or heat pump units with a circulation pump motor greater than or equal to 3.7 kW shall have two-way automatic isolation valves on each water cooled air-conditioning or heat pump unit that are interlocked with the compressor to shut off condenser water flow when the compressor is not operating.

5.3.6.3 Variable Speed Drives

Variable speed drives are required to control chilled water and condenser water systems for energy efficiency.

As per the Code,

Chilled water or condenser water systems that must comply with either §5.3.6.1 or §5.3.6.2 and that have pump motors greater than or equal to 3.7 kW shall be controlled by variable speed drives.

5.3.7 Unitary, Split and Packaged Air-Conditioners

Unitary air-conditioners shall meet or exceed the efficiency requirements given in Table 5-21 and Table 5-22. Window and split air conditioners shall be certified under BEE’s Star Labeling Program. EER shall be as per IS 8148 for all unitary, split, packaged air conditioners greater than 10 kW.

Table 5-21 Minimum Requirements for Unitary, Split, Packaged Air Conditioners in ECBC+ Building

Cooling Capacity (kW)	Water Cooled	Air Cooled
≤10.5	NA	BEE 4 Star
>10.5	3.7 EER	3.2 EER

Table 5-22 Minimum Requirements for Unitary, Split, Packaged Air Conditioners in SuperECBC Building

Cooling Capacity (kW)	Water Cooled	Air Cooled
≤10.5	NA	BEE 5 Star
>10.5	3.9 EER	3.4 EER

5.3.8 Controls for ECBC+ and SuperECBC buildings

ECBC+ and SuperECBC buildings shall comply with requirements of §0 in addition to complying with requirements of §5.2.3.

5.3.8.1 Centralized Demand Shed Controls

ECBC+ and SuperECBC Buildings with built up area greater than 20,000 m² shall have a building management system. All mechanical cooling and heating systems in ECBC+ and SuperECBC Buildings with any programmable logic controller (PLC) to the zone level shall have the following control capabilities to manage centralized demand shed in noncritical zones:

- (a) Automatic demand shed controls that can implement a centralized demand shed in non-critical zones during the demand response period on a demand response signal.
- (b) Controls that can remotely decrease or increase the operating temperature set points by four degrees or more in all noncritical zones on signal from a centralized control point
- (c) Controls that can provide an adjustable rate of change for the temperature setup and reset

The centralized demand shed controls shall have additional capabilities to

- (a) Be disabled by facility operators
- (b) Be manually controlled from a central point by facility operators to manage heating and cooling set points

5.3.8.2 Supply Air Temperature Reset

Cooling hot outside air takes energy. The colder the supply air, more energy it takes. A reset strategy saves energy by reducing the need to produce very cold air. For example, when a space

is not fully occupied, the supply air temperature can be increased to meet the lower demand. Reset strategy allows the building energy management system to adjust the supply of cold air to meet demand, balancing comfort versus energy cost.

As per the Code,

Multi zone mechanical cooling and heating systems in ECBC+ and SuperECBC Buildings shall have controls that automatically reset the supply-air temperature in response to building loads or to outdoor air temperature. Controls shall reset the supply air temperature to at least 25% of the difference between the design supply air temperature and the design room air temperature.

Exception to § 5.3.8.2 : ECBC+ and SuperECBC Buildings in warm humid climate zone.

5.3.8.3 Chilled Water Temperature Reset

Chilled-water reset adjusts the chilled-water set point to improve the efficiency of the chiller, reducing the energy consumption of the chiller. Usually, a chilled-water-reset strategy raises the set-point temperature when the building load is at less-than-design conditions. Producing warmer chilled water reduces the burden on the compressor, which means that the chiller consumes less energy.

Chilled water systems with a design capacity exceeding 350 kW_r supplying chilled water to comfort conditioning systems in ECBC+ and SuperECBC Buildings shall have controls that automatically reset supply water temperatures by representative building loads (including return water temperature) or by outdoor air temperature.

Exceptions to §5.3.8.2: Controls to automatically reset chilled water temperature shall not be required where the supply temperature reset

controls causes improper operation of equipment.

5.3.9 Controls for SuperECBC Buildings

SuperECBC Buildings shall comply with requirements of §5.3.9 in addition to complying with requirements of §5.2.3 and §0.

5.3.9.1 Variable Air Volume Fan Control

Fans in Variable Air Volume (VAV) systems in SuperECBC buildings shall have controls or devices that will result in fan motor demand of no more than 30% of their design wattage at 50% of design airflow based on manufacturer's certified fan data.

5.3.10 Energy Recovery

Energy recovery system help exchange/recover heat from the outgoing stale air so that the incoming air can be pre-cooled before reaching the air conditioning system.

The exhaust air exiting a building is warmer than the conditioned supply air but cooler than the outdoor air when the building is operating in cooling mode. Hence the heat exchange can provide additional benefit by reducing the load on the air conditioning system.

The system consists of a unit with fans or blowers and a rotating thermal wheel that transfers heat between two isolated airstreams. The wheel is made of material with high thermal conductivity to enable an efficient heat exchange. The two streams of air are kept isolated from each other. The thermal wheel can help exchange only the sensible heat in which case it is commonly referred to sensible wheel. Or it can also help recover moisture in addition to sensible heat, in which case it is referred to as enthalpy wheel.

As per the Code,

All Hospitality and Healthcare, with systems of capacity greater than 2,100 liters per second and minimum outdoor air supply of 70% shall have air-to-air heat recovery equipment with minimum 50% recovery effectiveness

Hospitality and healthcare buildings can have a dedicated 100% outdoor air supply system and various spaces that have a high minimum requirement for ventilation air. In such cases, energy recovery is beneficial.

The same concept that be applied to recover heat from exhaust gases of a generator set. As per the Code,

At least 50% of heat shall be recovered from diesel and gas fired generator sets installed in Hospitality, Healthcare, and Business buildings with built up area greater than 20,000 m².

5.3.11 Service Water Heating

For compliance with ECBC+ and SuperECBC,

- (a) Hospitality and Healthcare in all climatic zones shall have solar water heating equipment installed to provide atleast 40% of the total hot water design capacity.
- (b) All buildings in cold climate zone with a hot water system, shall have solar water heating equipment installed to provide atleast 60% of the total hot water design capacity.

Exception to §5.3.11: Systems that use heat recovery to provide the hot water capacity required as per the building type, size and efficiency level.

5.3.12 Total System Efficiency – Alternate Compliance Approach

A chilled water plant is a complex collection of individual components (chiller, pumps, cooling tower etc.) that have been designed to work together as a system (**Error! Reference source**

not found.). Energy efficiency requirements for each component of this system have been specified in this Code under various sections. However, Chillers, Pumps and Cooling towers shall be efficient not just individually but also when working together under various operating conditions. Therefore, the Chilled water plant efficiency as a whole is an important parameter to consider before Chilled water plant equipment selection.

Just like the Building Envelope Trade-off method, this alternative compliance method gives engineers the flexibility to show compliance for the entire Chilled water plant as one instead of meeting the individual equipment prescriptive requirements mentioned under §5.3.1 to §5.3.11.

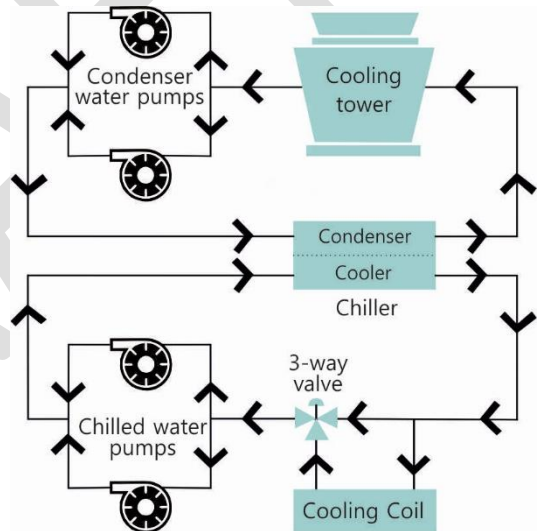

Figure 5.17 Chiller plant schematic

Compliance for this alternative path is to be demonstrated by hourly energy simulation using a BEE approved energy simulation software.

As per the Code,

This alternate compliance approach is applicable for central chilled water plant side system in all building types. The total installed capacity per kilo-watt refrigeration load shall be less than or

equal to maximum threshold requirements as specified in **Error! Reference source not found.** Equipment that can be included in central chilled water plant side system for this alternate approach are chillers, chilled water pumps, condenser water pumps, and cooling tower fan. Compliance check will be based on annual hourly simulation.

Table 5-23 Minimum System Efficiency Requirement for ECBC, ECBC+, and SuperECBC Buildings

Water Cooled Chilled Water Plant	Maximum Threshold (kW/kWr)
ECBC	0.26
ECBC+	0.23
SuperECBC	0.20

5.3.12.1 Documentation Requirement

Compliance shall be documented, and compliance forms shall be submitted to the authority having jurisdiction. The information submitted shall include, at a minimum, the following:

- (a) Summary describing the results of the analysis, including the annual energy use (kWh) of chilled water plant (chillers, pumps and cooling tower) and annual chilled water use (kWrh) for the Proposed Design, and software used.
- (b) Brief description of the project with location, number of stories, space types, conditioned and unconditioned areas, hours of operation.
- (c) List of the energy-related building features of the Proposed Design.
- (d) List showing compliance with the mandatory requirements of this code.
- (e) The input and output report(s) from the simulation program including an energy and chilled water usage components: space cooling and heat rejection equipment, and

other HVAC equipment (such as pumps). The output reports shall also show the number of hours any loads are not met by the HVAC system the Proposed Design.

- (f) Explanation of any significant modelling assumptions made.
- (g) Explanation of any error messages noted in the simulation program output.

The total system efficiency shall be calculated as follows:

$$\text{Total System Efficiency} = \frac{\text{Chilled water plant use (kWh)}}{\text{Chilled Water use (kWrh)}}$$

5.3.13 Low-energy Comfort Systems

Alternative HVAC systems which have low energy use may be installed in place of (or in conjunction with) refrigerant-based cooling systems. Using low energy reduces the need for fossil fuel which consequently reduces the greenhouse gas emissions. Further, using non-fluorinated refrigerants helps mitigate global warming. Considering the viability of low energy systems to provide comfort should be the first step towards achieving energy efficiency. Once this is assessed, any residual cooling loads could be met using refrigerant-based systems.

For example, a large museum building can be zoned such that the non-exhibit spaces could use a low energy radiant cooling or evaporating cooling system (as per the climate) since the intent is to provide comfort for occupants. Whereas, the exhibit spaces could be conditioned using chillers since stringent climate control is essential for preserving the artefacts. This can reduce the overall plant size resulting in an energy efficient system.

The approved list of low energy comfort systems¹ is given below:

(a) Evaporative cooling

This system forces hot outdoor air over a wet media. The water evaporates by removing the heat from the air while adding moisture. This system is efficient in a hot-dry climate where the addition of humidity provides comfort. Moreover, this is a 100% outdoor air system. Thus, this system uses water as a cooling system and few fans and pumps which makes it a low-energy comfort system. This system can also be provided for a large scale building such as schools where the cool air can be supplied through ducts.

(b) Desiccant cooling system

A desiccant is a substance, either solid or liquid, which absorbs water molecules from air and dehumidifies it. The desiccant, initially used to absorb moisture from the air, is later regenerated by heating the desiccant so that it releases the absorbed moisture. This phase change cycle is a continuous process that drives the operation of desiccant systems. Research projects are underway to make the application more viable.

(c) Solar air conditioning

Cooling loads in India peak during the hot summer season when solar radiation is available in abundance. Thus, application of solar cooling technology uses a renewable source of energy to reduce the cooling loads when air conditioning demand is at its annual high. Principle behind the functioning of solar cooling is the use of solar heat/ thermal energy to re-generate the refrigerant in absorption chiller or desiccant in a desiccant chiller.

(d) Tri-generation (waste-to-heat)

Trigeneration is the simultaneous production of three forms of energy—typically, cooling, heating and power—from only one fuel input. In a typical trigeneration system, gas fired generators are used to produce electricity. This process generates waste heat, which is then directed to the chillers and boilers. In this system, absorption chillers are used to produce chilled water for space cooling. Boilers generate hot water for space heating and other purposes. Since electricity is produced on-site, it minimizes the green house gas emissions and transmission losses that occur when using electricity from the grid.

(e) Radiant cooling system

The guiding principle in this system is heat transfer through radiation. Radiant systems are installed in combination of large thermal mass to facilitate absorption and radiation. Radiant cooling systems consist of coils embedded within the structure. These coils carry chilled water generated either through conventional electric chiller systems or low energy chilled water generation systems like absorbent chillers, desiccant chillers. Chilled water in the coils cools down the slab or panels which in turn act as heat sinks for sensible heat loads of internal spaces.

Application of radiant systems is limited to areas which have high latent load and chances of air leakage from humid areas are high.

(f) Ground source heat pump

A Ground Source Heat Pump (GSHP) system heats and cools building by using earth as a heat source or heat sink. The system either extracts thermal energy out of the ground or transfers thermal energy from buildings to the

¹ This is not an all-inclusive list. The updated list of low energy comfort systems is available at BEE website (<https://www.beeindia.gov.in/>).

ground. Heat could be pumped in during summers to the ground, where the temperature is lower than the ambient temperature. This system is more suitable for composite climate as continuous pumping of heat to ground could make the ground saturated

(g) Adiabatic cooling system

Adiabatic cooling is a cooling process that provides air cooling by expanding or compressing the pressure of air or a substance. This cooling process changes air pressure without losing or gaining heat.

As per the Code, buildings using low energy comfort system must still comply with all the mandatory requirements as applicable. As per the Code,

Such systems shall be deemed to meet the minimum space conditioning equipment efficiency levels of §5.2.2, but shall comply with all other applicable mandatory provisions of §5.2 as applicable. Wherever applicable, requirements of §5.3 and §5.3.12 will be complied with.

Buildings with an approved low-energy comfort system installed for more than 50% of the cooling and heating requirement of the building shall be deemed equivalent to the ECBC+ building standard prescribed in § 5.2.2.

Buildings having an approved low energy comfort system installed for more than 90% of the cooling and heating requirement of the building shall be deemed equivalent to the SuperECBC building standard prescribed in §5.2.2.

Considering the potential of low energy system sometimes thermal storage may be used for limiting maximum demand, by controlling peak electricity load through reduction of chiller capacity, and by taking advantage of high system efficiency during low ambient conditions.

Thermal storage would also help in reducing operating cost by using differential time-of-the day power tariff, where applicable.

The storage media can be ice or water. Water needs stratified storage tanks and is mostly viable with large storage capacity and has an advantage of plant operation at higher efficiencies but requires larger storage volumes. In case of central plant designed with thermal energy storage, its location shall be decided in consultation with the air conditioning engineer.

For roof top installations, structural provision shall take into account load coming on the building/structure due to the same. For open area surface installation, horizontal or vertical system options shall be considered and approach ladders for manholes provided. Buried installation shall take into account loads due to movement of vehicles above the area.

5.3.13.1 Documentation Requirement

Compliance shall be documented and submitted to the authority having jurisdiction. The information submitted shall include, at a minimum, the following:

- (a) Summary describing the low-energy comfort system type, capacity, and efficiency.
- (b) List of showing compliance with the mandatory and prescriptive requirements other than exempted in §5.3.13.
- (c) Comparison of installed capacity of approved low-energy comfort system with other HVAC system to meet the comfort requirement of the building.

6 Lighting & Controls

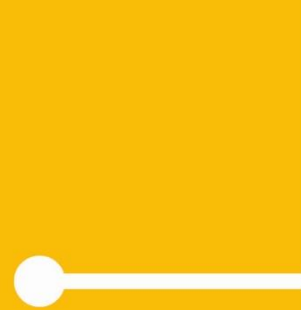

LIGHTING AND CONTROLS

INTENT

Lighting energy use is significant in commercial buildings, it also offers many energy efficiency opportunities in almost any facility, existing or new. With high efficacy luminaires and advanced controls available in the market today, it is possible to achieve lower lighting power density and reduce building energy use. The Code addresses two key areas for reducing lighting energy use – controls and lighting power requirements.

SECTION ORGANIZATION

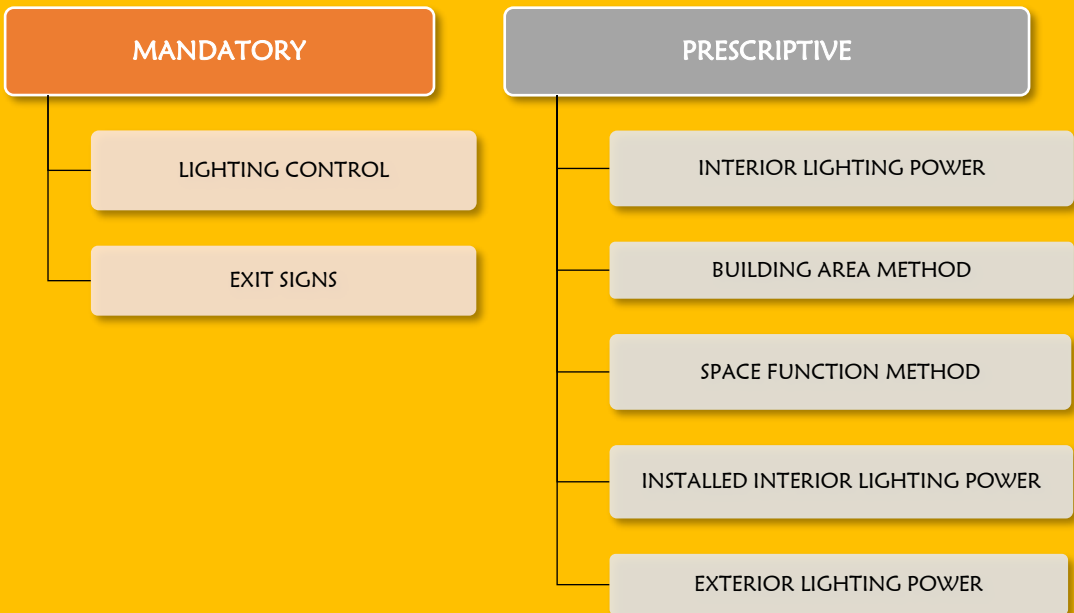

6. LIGHTING AND CONTROLS

6.1 General

Lighting accounts for 15% of total energy consumption in India. Lighting is an area that offers many energy efficiency opportunities in almost any building facility, existing or new.

A century ago, a person could read by the light of a single candle, but today a person in a typical office uses hundreds or even thousand times more light. Over the years, illumination standards have increased radically along with efficiency of lamps.

People want light for different reasons, and a good lighting designer need to keep all of them in mind. Different tasks and building facilities require different amounts and types of light. For example, a surgeon in an operation theater needs lots of light with low glare and excellent color rendering, restaurant owners and diners often want low light levels, corporate boardrooms call for lighting that reinforces a feeling of importance and success while adapting to audio-visual presentations; retail outlets in many situations want to make their merchandise sparkle so that it draws the customers and encourages them to buy. An office executive needs modest ambient lighting level, good task lighting on work surface, and minimal glare to effectively read and work on computers.

While energy efficiency is an attractive goal for many reasons, lighting designers also need to consider a host of other factors, including the effect of quality of light on the visual comfort and productivity of the occupants. Small improvement in lighting quality can improve productivity of the user substantially. In practice,

the right quality and quantity of light can be provided efficiently (with less energy) by using the right technology and its effective integration with daylight.

General Design Considerations

Using efficient lighting equipment and controls is the best way to ensure lighting energy efficiency while maintaining or even improving lighting conditions. For instance, modern fluorescent lighting, such as electronically ballasted T-8 systems, can provide the same quantity of light as older fluorescent lighting while consuming as little as two-thirds of the energy. Similarly, compact fluorescent sources are three to four times more efficient than the traditional incandescent lamps they are designed to replace.

For a lighting designer an energy-efficient lighting design involves sensitive integration of many requirements and considerations that include building orientation, interior building layout, task illumination, daylight strategies, glazing specification, choice of lighting system and controls etc. The designer is also responsible for making sure that lighting complies with the Code, meeting both mandatory and prescriptive requirements. As per the Code,

Lighting systems and equipment shall comply with the mandatory provisions of §6.2 and the prescriptive criteria of §6.3. The lighting requirements in this section shall apply to:

- (a) Interior spaces of buildings,
- (b) Exterior building features, including facades, illuminated roofs, architectural features, entrances, exits, loading docks, and illuminated canopies, and,
- (c) Exterior building grounds lighting that is provided through the building's electrical service.

Exceptions to §6.1:

- (a) Emergency lighting that is automatically off during normal building operations.

6.2 Mandatory Requirements

The mandatory requirements for lighting mostly relate to interior and exterior lighting controls.

6.2.1 Lighting Control

Lighting controls allow lighting to be turned down or completely off when it is not needed – the simplest way to save energy. Maximizing the use of controls involves developing a set of strategies that utilize the Code requirements for various devices, including on-off controls, dimming controls, and systems that combine the use of both types of equipment.

These controls can be quite sophisticated, but in general, they perform two basic functions:

- 1) Turn lights off when not needed, and
- 2) Modulate light output so that no more light than necessary is produced.

The equipment required to achieve these functions varies in complexity from simple timers to intricate electronic dimming circuits, each applicable to different situations. Controls include time clocks, occupant and motion sensors, automatic or manual daylighting controls, and astronomical time switches (the automatic switches that adjust for the length of the day as it varies over the year).

Manual Vs. Automatic Controls

Manual lighting controls range from a single switch to a bank of switches and dimmers that are actuated by toggles, rotary knobs, push buttons, remote control, and other means. Manual controls can be cost-effective options for small-scale situations. However, as the lighting system becomes larger, automated systems become more cost-effective and are better at

controlling light. Manual controls may not give the desired results in real situations because the decision to shut off the lights when they are not needed is based entirely on human initiative. It is worthwhile to determine the amount of local vs. central control that is needed from the lighting control system.

6.2.1.1 Automatic Lighting Shutoff

Although there is no simpler way to reduce the amount of energy consumed by lighting systems than to manually turn lights off whenever not needed, this is not done as often as it could be. In response to that problem, the Code requires several automatic switches that either work on time schedule or sense the presence of occupants.

Automatic Control Strategies

Several different approaches can be used to control electric lighting. The control hardware and design practices are discussed below:

Scheduling Control: Use a time scheduling device to control lighting systems according to predetermined schedules.

Occupancy Sensing: Control lights in response to the presence or absence of people in the space.

Daylighting: Switch or dim electric lights in response to the presence or absence of daylight illumination in the space.

Lumen Maintenance: Gradually adjust electric light levels over time to correspond with the depreciation of light output from aging lamps.

Scheduling Controls

Programmable timing, also known as automatic time scheduling, is the oldest form of automatic lighting control. Time scheduling manages the on and off times of a building's lighting systems.

Scheduling systems function by turning off all or some of the lights when a building space is

unoccupied. In the most basic time-scheduling scheme, a time switch switches lighting circuits on or off based on programmable schedules. For example, exterior lighting is usually switched on to correspond to sundown and is switched off again at daybreak. By contrast, time scheduling of interior lighting systems is based, for the most part, on occupancy schedules. In some cases, time switches are used to energize additional lighting control systems, such as daylighting controls, which are held off during unoccupied periods. Time-scheduling systems employ the following components:

- A central processor is usually capable of controlling several output channels, each of which may be assigned to one or more lighting circuits.
- Relays are series-wired to lighting control zones and are controlled by the central processor.
- Overrides are required to accommodate individuals who use the space during scheduled off hours. Individuals can activate manual switches or use telephone overrides to regain temporary control of the lights in a given space.

Occupancy Sensors

Occupant-sensing devices are an alternative to scheduling controls and an acceptable means of meeting the requirement for automatic shutoff.

Occupancy sensors are automatic scheduling devices that detect motion and turn lights on and off accordingly. Most devices can be calibrated for sensitivity and for the length-of-time delay between the last detected occupancy and extinguishing of the lights. The most energy-efficient occupancy sensors, known as “manual on, automatic-off,” require that the user manually switch on the lights when entering a controlled zone (the “lights off” function is still automatic).

Occupancy sensor systems typically consist of a motion detector, a control unit, and a relay. Usually, two or more of the components are integrated into one package. Most systems also require a power supply in the form of a transformer, which steps down the building voltage to 24V. The detector collects information, then sends it to the controller, where it is processed. Output from the controller activates the relay, which in turn switches the light circuit.

There are two major types of occupancy controls.

- **Wallbox** units are designed to fit into a standard wall switch box and operate on the building voltage (i.e., a separate power supply is not required). Their main limitation is their relatively short range. Consequently, they tend to be used in small offices and meeting rooms.
- **Wall and Ceiling** units typically contain an integrated sensor/controller unit wired (Class 2) to a switch pack containing the relay and power supply. They are far more popular than wallbox units and have very few application limitations.

The designer is free to arrange occupant sensing controls in any manner that makes sense for the building design. In office spaces, each room or space might have an occupant sensor. Of course, the smaller the area controlled, the greater the energy savings will be. In open office areas, several occupant sensors may be connected so that the lights remain on if any one of the sensors detects occupants. However, in order to satisfy the Code requirement, it is necessary that all the general lighting be controlled by one or more occupant sensors.

As per the Code,

- (a) 90% of interior lighting fittings in building or space of building larger than 300 m² shall be equipped with automatic control device.
- (b) Additionally, occupancy sensors shall be provided in
 - (i) All building types greater than 20,000 m² BUA, in
 - a. All habitable spaces less than 30 m², enclosed by walls or ceiling height partitions.
 - b. All storage or utility spaces more than 15 m² in all building types with BUA greater than 20,000 m².
 - c. Public toilets more than 25 m², controlling at least 80 % of lighting fitted in the toilet. The lighting fixtures, not controlled by automatic lighting shutoff, shall be uniformly spread in the area.
 - (ii) In corridors of all Hospitality greater than 20,000 m² BUA, controlling minimum 70% and maximum 80% of lighting fitted in the public corridor. The lighting fixtures, not controlled by automatic lighting shut off, shall be uniformly spread in the area.
 - (iii) In all Business and all conference or meeting rooms.
- (c) Automatic control device shall function on either:
 - (i) A scheduled basis at specific programmed times. An independent program schedule shall be provided for areas of no more than 2,500 m² and not more than one floor, or,
 - (ii) Occupancy sensors that shall turn off the lighting fixtures within 15 minutes of an occupant leaving the space. Light fixtures controlled by occupancy

sensors shall have a wall-mounted, manual switch capable of turning off lights when the space is occupied.

Exception to §6.2.1.1: Lighting systems designed for emergency and firefighting purposes.

6.2.1.2 Space Control

Along with controls for individual lights or sets of fixtures, master controls are required for each space which can shut off all the lights within the space. For example, the last person leaving the office is much more likely to use a master switch than to go through the office turning off every switch. Similarly, a cleaning crew can easily use master switches to turn lights off at the end of a working day.

Each space enclosed by ceiling-height partitions shall have at least one control device to independently control the general lighting within the space. Each control device shall be activated either manually by an occupant or automatically by sensing an occupant. Each control device shall

- (a) control a maximum of 250 m² for a space less than or equal to 1,000 m², and a maximum of 1,000 m² for a space greater than 1,000 m².
- (b) have the capability to override the shutoff control required in § 6.2.1.1 for no more than 2 hours, and
- (c) be readily accessible and located so the occupants can see the control.

A summary of the Code requirement is given below.

ECBC requirements: Space Area and Lighting Controls

S.No.	Space Area	Coverage Area for each control device
1	Up to 1000 m ²	250 m ² max.
2	More than 1000 m ²	1000 m ² max.

An exception to § 6.2.1.2 (c) is provided for control devices that need to be remotely installed for reasons of safety or security. However, a remotely located device must have a pilot light indicator as part of or next to the control device and it must be clearly labeled to identify the controlled lighting device.

6.2.1.3 Control in Daylight Areas

Daylight controls enable daylight harvesting. This is a technique using which the artificial lighting is controlled by switching off or dimming in response to the available daylight levels. Thus, daylight controls reduce lighting energy use while providing visual comfort.

Depending the size of the fenestrations and specifications such as the VLT, the daylit area can extend upto two times the head height of the fenestration. Luminaires located in this area should be controlled by the daylight sensor.

A daylight sensor is basically a photosensor that can detect lux levels and converts it to analog voltage that controls the ballast of the luminaire. Dimmable luminaires allow continuous adjustment of light level in proportion to the available natural light. Dimming the light reduces the electric power demand contributing to energy savings.

In the other approach, the luminaire is switched off when the daylight level reaches a predefined level as detected by the photosensor. Another variant of this on-off switching is the step switching or the “bi-level switching”. In this method, multiple lamps in a single luminaire can be switched on or off independent of each other.

For example, the luminaire output can be stepped down one level and reduced to 50% before turning it off completely.

As per the Code,

- (a) Luminaires, installed within day lighting extent from the window as calculated in § 4.2.3, shall be equipped with either a manual control device to shut off luminaires, installed within day lit area, during potential daylit time of a day or automatic control device that:
 - I. Has a delay of minimum 5 minutes, or,
 - II. Can dim or step down to 50% of total power.
- (b) Overrides to the daylight controls shall not be allowed.
- (c) For SuperECBC Buildings, Lighting Power Density adjustment factor of 20% shall be allowed to all spaces with more than 70% of their area under daylight controls.

6.2.1.4 Exterior Lighting Control

Exterior lighting could be installed on the sire outside the building, integrated in landscape design, integrated in façade or could be used for highlighting special design feature as well. Energy efficiency can be achieved by improving the lamp efficacy, reducing the connected wattage and having good controls.

As per the Code,

- (a) Lighting for all exterior applications not exempted in §6.3.5 shall be controlled by a photo sensor or astronomical time switch that is capable of automatically turning off the exterior lighting when daylight is available or the lighting is not required.
- (b) Lighting for all exterior applications, of Schools and Business with built up area

greater than 20,000 m², shall have lamp efficacy not less than 80 lumens per watt, 90 lumens per watt, and 100 lumens per watt, for ECBC, ECBC+, and SuperECBC Buildings respectively, unless the luminaire is controlled by a motion sensor or exempt under §6.1.

- (c) Façade lighting and façade non-emergency signage of Shopping Complexes shall have separate time switches.

Exemption to §6.2.1.4: Exterior emergency lighting.

6.2.1.5 Additional Control

Many special lighting applications must be controlled separately, including display lighting in retail stores, case lighting, hotel/motel guest rooms, task lighting, non-visual lighting applications, and demonstration lighting.

As per the Code,

The following lighting applications shall be equipped with a control device to control such lighting independently of general lighting:

- (a) **Display/ Accent Lighting** Display or accent lighting greater than 300 m² area shall have a separate control device.

Lighting used to highlight artwork or merchandise in retail stores, art galleries, lobbies, and other spaces must have a separate lighting control. This additional control can save considerable energy since the hours required for display lighting are generally fewer than the hours that the space is occupied.

In a retail store, for instance, employees typically arrive one to two hours before the store opens in order to prepare the store, and often employees need to stay for an hour or two after the store closes. Without a separate control for display lighting, the display lighting would have to be

operated for two to four hours each day when it isn't needed. Controls for display lighting can be situated in remote locations, but it is advisable that they have indicator lights and be clearly marked to indicate which lighting is controlled.

- (b) **Hotel Guest Room Lighting.** Guest rooms and guest suites in a hotel shall have a master control device at the main room entry that controls all permanently installed luminaires and switched receptacles.

A master lighting control is required at the entry door of hotel and motel guest rooms to control all permanently installed luminaires and switched receptacles. The control is usually a three-way device wired in combination with local controls. In multiple-room suites, a single master control must be located at the main entrance. This master lighting control allows guests or the housekeeping staff to turn off all permanently installed luminaires when they are exiting the room.

- (c) **Task Lighting.** Supplemental task lighting including permanently installed under shelf or under cabinet lighting shall have a control device integral to the luminaires or be controlled by a wall-mounted control device provided the control device complies with §6.2.1.2.

All supplemental task lighting in a space shall have a separate control. Desk lamps will inherently meet this requirement, but the requirement also applies to permanently installed under-shelf or under-cabinet lighting. Such lighting can have a switch integral to the luminaires or be controlled by a wall-mounted control device, provided the control device is accessible and the controlled lighting can be observed when the switch is toggled

- (d) **Nonvisual Lighting.** Lighting for nonvisual applications, such as plant

growth and food-warming, shall be equipped with a separate control device.

Lighting needed for non-visual purposes, such as plant growth or food warming, must have a separate control. This is because such lighting is likely to be needed at different times than the general lighting.

- (e) **Demonstration Lighting.** Lighting equipment that is for sale or for demonstrations in lighting education shall be equipped with a separate control device accessible only to authorized personnel.

Lighting on display in retail lighting stores and lighting that is being demonstrated in classrooms and lighting education facilities must have a separate control. Again, the justification is that such lighting is operated on a separate schedule from the general lighting

6.2.2 Exit Signs

Internally-illuminated exit signs shall not exceed 5 Watts per face.

Electrically powered exit signs normally use incandescent bulbs. Most LED and some CFL exit signs can meet ECBC requirement. Due to their low power consumption, LED exit signs can be purchased with built-in backup power supplies (i.e., batteries). With an estimated service life of 10 years or more, LEDs require significantly fewer lamp replacements than exit signs equipped with either incandescent lamps or CFLs.

6.3 Prescriptive Requirements

The prescriptive requirement of the Code regulates both interior and exterior lighting power.

6.3.1 Interior Lighting Power

The prescriptive lighting requirements limit the installed electric wattage for interior building lighting. Interior lighting includes all permanently installed general and task lighting shown on the plans. Interior lighting, for a building or a separately metered or permitted portion of a building, shall not exceed allowed power limits.

As per the Code,

The installed interior lighting power for a building or a separately metered or permitted portion of a building shall be calculated in accordance with §6.3.4 and shall not exceed the interior lighting power allowance determined in accordance with either §6.3.2 or §6.3.3. **Error! Reference source not found..** Tradeoffs of interior lighting power allowance among portions of the building for which a different method of calculation has been used are not permitted.

As with the other sections of the Code, however, these lighting power requirements are minimum requirements. Designers working on specific projects may often be able to design more efficient lighting systems.

There are many exceptions to the lighting power requirement, generally for specialized lighting. These are listed in ECBC §6.3.1.

For interior lighting power requirements, the installed lighting power used by luminaires, including lamps, ballasts, current regulators, and central devices (except as specifically exempted in 7.1) can be calculated using the Building Area Method or the Space Function Method. These are explained in detail in the further sections.

6.3.2 Building Area Method

This method provides the procedure of calculating total watts per square meter for the entire building based on its type. The sum of all the interior lighting power for various areas of

the building cannot exceed the total watts to be in compliance. The building area method is the simplest method to follow since fewer calculations are required. However, if the project applies to only a portion of the entire building, is not listed as a building type, or has more than one occupancy type, the space function method should be used to determine compliance.

The allowed lighting power density can be calculated in the following two steps as per the Building Area Method

1. Calculate the gross lighted carpet area for each building area type.
2. The interior lighting power allowance is the sum of the products of the gross lighted floor area of each building area times the allowed lighting power density for that building area type.

The lighting power for appropriate building area type can be selected from for ECBC Buildings, from Table 6-2 for ECBC+ Buildings and from Table 6-3 for SuperECBC Buildings.

DRAFT

Table 6-1 Interior Lighting Power for ECBC Buildings – Building Area Method

<i>Building Type</i>	<i>LPD (W/m²)</i>	<i>Building Area Type</i>	<i>LPD (W/m²)</i>
<i>Office Building</i>	<i>9.50</i>	<i>Motion picture theater</i>	<i>9.43</i>
<i>Hospitals</i>	<i>9.70</i>	<i>Museum</i>	<i>10.2</i>
<i>Hotels</i>	<i>9.50</i>	<i>Post office</i>	<i>10.5</i>
<i>Shopping Mall</i>	<i>14.1</i>	<i>Religious building</i>	<i>12.0</i>
<i>University and Schools</i>	<i>11.2</i>	<i>Sports arena</i>	<i>9.70</i>
<i>Library</i>	<i>12.2</i>	<i>Transportation</i>	<i>9.20</i>
<i>Dining: bar lounge/leisure</i>	<i>12.2</i>	<i>Warehouse</i>	<i>7.08</i>
<i>Dining: cafeteria/fast food</i>	<i>11.5</i>	<i>Performing arts theater</i>	<i>16.3</i>
<i>Dining: family</i>	<i>10.9</i>	<i>Police station</i>	<i>9.90</i>
<i>Dormitory</i>	<i>9.10</i>	<i>Workshop</i>	<i>14.1</i>
<i>Fire station</i>	<i>9.70</i>	<i>Automotive facility</i>	<i>9.00</i>
<i>Gymnasium</i>	<i>10.0</i>	<i>Convention center</i>	<i>12.5</i>
<i>Manufacturing facility</i>	<i>12.0</i>	<i>Parking garage</i>	<i>3.00</i>
<i>In cases where both a general building area type and a specific building area type are listed, the specific building area type shall apply.</i>			

Table 6-2 Interior Lighting Power for ECBC+ Buildings – Building Area Method

<i>Building Area Type</i>	<i>LPD (W/m²)</i>	<i>Building Area Type</i>	<i>LPD (W/m²)</i>
<i>Office Building</i>	<i>7.60</i>	<i>Motion picture theater</i>	<i>7.50</i>
<i>Hospitals</i>	<i>7.80</i>	<i>Museum</i>	<i>8.20</i>
<i>Hotels</i>	<i>7.60</i>	<i>Post office</i>	<i>8.40</i>
<i>Shopping Mall</i>	<i>11.3</i>	<i>Religious building</i>	<i>9.60</i>
<i>University and Schools</i>	<i>9.00</i>	<i>Sports arena</i>	<i>7.80</i>
<i>Library</i>	<i>9.80</i>	<i>Transportation</i>	<i>7.40</i>
<i>Dining: bar lounge/leisure</i>	<i>9.80</i>	<i>Warehouse</i>	<i>5.70</i>
<i>Dining: cafeteria/fast food</i>	<i>9.20</i>	<i>Performing arts theater</i>	<i>13.0</i>
<i>Dining: family</i>	<i>8.70</i>	<i>Police station</i>	<i>7.90</i>
<i>Dormitory</i>	<i>7.30</i>	<i>Workshop</i>	<i>11.3</i>
<i>Fire station</i>	<i>7.80</i>	<i>Automotive facility</i>	<i>7.20</i>
<i>Gymnasium</i>	<i>8.00</i>	<i>Convention center</i>	<i>10.0</i>
<i>Manufacturing facility</i>	<i>9.60</i>	<i>Parking garage</i>	<i>2.40</i>
<i>In cases where both a general building area type and a specific building area type are listed, the specific building area type shall apply.</i>			

Table 6-3 Interior Lighting Power for SuperECBC Buildings – Building Area Method

Building Area Type	LPD (W/m ²)	Building Area Type	LPD (W/m ²)
Office Building	5.0	Motion picture theater	4.7
Hospitals	4.9	Museum	5.1
Hotels	4.8	Post office	5.3
Shopping Mall	7.0	Religious building	6.0
University and Schools	6.0	Sports arena	4.9
Library	6.1	Transportation	4.6
Dining: bar lounge/leisure	6.1	Warehouse	3.5
Dining: cafeteria/fast food	5.8	Performing arts theater	8.2
Dining: family	5.5	Police station	5.0
Dormitory	4.6	Workshop	7.1
Fire station	4.9	Automotive facility	4.5
Gymnasium	5.0	Convention center	6.3
Manufacturing facility	6.0	Parking garage	1.5
<i>In cases where both a general building area type and a specific building area type are listed, the specific building area type shall apply.</i>			

6.3.3 Space Function Method

The allowable lighting power density can be calculated by the Space Function Method in the following steps.

- (a) Determine the appropriate building type and the allowed lighting power density from Table 6-4 for ECBC Buildings, Table 6-5 for ECBC+ Buildings and, Table 6-6 for SuperECBC Buildings. In cases where both a common space type and building specific space type are listed, building specific space type LPD shall apply.
- (b) For each space, enclosed by partitions 80% or greater than ceiling height, determine the gross carpet area by measuring to the face of the partition wall. Include the area of balconies or other projections. Retail spaces do not have to
- comply with the 80% partition height requirements.
- (c) The interior lighting power allowance is the sum of the lighting power allowances for all spaces. The lighting power allowance for a space is the product of the gross lighted carpet area of the space times the allowed lighting power density for that space

Table 6-4 Interior Lighting Power for ECBC Buildings – Space Function Method

Category	LPD (W/m ²)	Lamp category	LPD (W/m ²)
Common Space Types			
Restroom	7.70	Stairway	5.50
Storage	6.80	Corridor/Transition	7.10
Conference/ Meeting	11.5	Lobby	9.10
Parking Bays (covered/ basement)	2.20	Parking Driveways (covered/ basement)	3.00
Electrical/Mechanical	7.10	Workshop	17.1
Business			
Enclosed	10.0	Open Plan	10.0
Banking Activity Area	12.6	Service/Repair	6.80
Healthcare			
Emergency	22.8	Recovery	8.60
Exam/Treatment	13.7	Storage	5.50
Nurses' Station	9.40	Laundry/Washing	7.50
Operating Room	21.8	Lounge/Recreation	8.00
Patient Room	7.70	Medical Supply	13.7
Pharmacy	10.7	Nursery	5.70
Physical Therapy	9.70	Corridor/Transition	9.10
Radiology/Imaging	9.10		
Category	LPD (W/m ²)	Lamp category	LPD (W/m ²)
Hospitality			
Hotel Dining	9.10	Hotel Lobby	10.9
For Bar Lounge/ Dining	14.1	Motel Dining	9.10
For food preparation	12.1	Motel Guest Rooms	7.70
Hotel Guest Rooms	9.10		
Shopping Complex			
Mall Concourse	12.8	For Family Dining	10.9
Sales Area	18.3	For food preparation	12.1
Motion Picture Theatre	9.60	Bar Lounge/ Dining	14.1
Educational			
Classroom/Lecture	13.7	Card File and Cataloguing	9.10
For Classrooms	13.8	Stacks (Lib)	18.3
Laboratory	15.1	Reading Area (Library)	10.0
Assembly			

<i>Dressing Room</i>	<i>9.10</i>	<i>Seating Area - Performing Arts Theatre</i>	<i>22.6</i>
<i>Exhibit Space - Convention Centre</i>	<i>14.0</i>	<i>Lobby - Performing Arts Theatre</i>	<i>21.5</i>
<i>Seating Area - Gymnasium</i>	<i>4.60</i>	<i>Seating Area - Convention Centre</i>	<i>6.40</i>
<i>Fitness Area - Gymnasium</i>	<i>13.70</i>	<i>Seating Religious Building</i>	<i>16.4</i>
<i>Museum - General Exhibition</i>	<i>16.40</i>	<i>Playing Area - Gymnasium</i>	<i>18.8</i>
<i>Museum - Restoration</i>	<i>18.3</i>		

Table 6-5 Interior Lighting Power for ECBC+ Buildings – Space Function Method

<i>Category</i>	<i>LPD (W/m²)</i>	<i>Lamp category</i>	<i>LPD (W/m²)</i>
Common Space Types			
<i>Restroom</i>	<i>6.10</i>	<i>Stairway</i>	<i>4.40</i>
<i>Storage</i>	<i>5.40</i>	<i>Corridor/Transition</i>	<i>3.60</i>
<i>Conference/ Meeting</i>	<i>9.20</i>	<i>Lobby</i>	<i>7.30</i>
<i>Parking Bay (covered/ basement)</i>	<i>1.75</i>	<i>Parking Driveways (covered/ basement)</i>	<i>2.50</i>
<i>Electrical/Mechanical</i>	<i>5.70</i>	<i>Workshop</i>	<i>13.7</i>
Business			
<i>Enclosed</i>	<i>8.60</i>	<i>Open Plan</i>	<i>8.60</i>
<i>Banking Activity Area</i>	<i>9.30</i>	<i>Service/Repair</i>	<i>5.50</i>
Healthcare			
<i>Emergency</i>	<i>18.2</i>	<i>Recovery</i>	<i>7.00</i>
<i>Exam/Treatment</i>	<i>10.9</i>	<i>Storage</i>	<i>4.40</i>
<i>Nurses' Station</i>	<i>7.50</i>	<i>Laundry/Washing</i>	<i>6.00</i>
<i>Operating Room</i>	<i>17.5</i>	<i>Lounge/Recreation</i>	<i>6.40</i>
<i>Patient Room</i>	<i>6.10</i>	<i>Medical Supply</i>	<i>10.9</i>
<i>Pharmacy</i>	<i>8.50</i>	<i>Nursery</i>	<i>4.60</i>
<i>Physical Therapy</i>	<i>7.80</i>	<i>Corridor/Transition</i>	<i>7.30</i>
<i>Radiology/Imaging</i>	<i>7.30</i>		
Hospitality			
<i>Hotel Dining</i>	<i>7.30</i>	<i>Hotel Lobby</i>	<i>8.80</i>
<i>For Bar Lounge/ Dining</i>	<i>11.3</i>	<i>Motel Dining</i>	<i>7.30</i>
<i>For food preparation</i>	<i>12.1</i>	<i>Motel Guest Rooms</i>	<i>6.10</i>
<i>Hotel Guest Rooms</i>	<i>7.30</i>		
Shopping Complex			

<i>Mall Concourse</i>	<i>10.2</i>	<i>For Family Dining</i>	<i>8.80</i>
<i>Sales Area</i>	<i>14.6</i>	<i>For food preparation</i>	<i>12.1</i>
<i>Motion Picture Theatre</i>	<i>10.3</i>	<i>Bar Lounge/ Dining</i>	<i>11.3</i>
Educational			
<i>Classroom/Lecture</i>	<i>10.9</i>	<i>Card File and Cataloguing</i>	<i>7.30</i>
<i>For Classrooms</i>	<i>11.0</i>	<i>Stacks (Library)</i>	<i>14.6</i>
<i>Laboratory</i>	<i>12.1</i>	<i>Reading Area (Library)</i>	<i>9.20</i>
Assembly			
<i>Dressing Room</i>	<i>7.30</i>	<i>Seating Area - Performing Arts Theatre</i>	<i>18.1</i>
Category	LPD (W/m²)	Lamp category	LPD (W/m²)
<i>Exhibit Space - Convention Centre</i>	<i>11.2</i>	<i>Lobby - Performing Arts Theatre</i>	<i>17.2</i>
<i>Seating Area - Gymnasium</i>	<i>3.60</i>	<i>Seating Area – Convention Centre</i>	<i>5.10</i>
<i>Fitness Area - Gymnasium</i>	<i>7.85</i>	<i>Seating Religious Building</i>	<i>13.1</i>
<i>Museum - General Exhibition</i>	<i>11.3</i>	<i>Playing Area - Gymnasium</i>	<i>12.9</i>
<i>Museum - Restoration</i>	<i>11.0</i>		

Table 6-6 Interior Lighting Power for SuperECBC Buildings – Space Function Method

Category	LPD (W/m²)	Lamp category	LPD (W/m²)
Common Space Types			
<i>Restrooms</i>	<i>3.80</i>	<i>Stairway</i>	<i>2.70</i>
<i>Storage</i>	<i>3.40</i>	<i>Corridor/Transition</i>	<i>2.30</i>
<i>Conference/ Meeting</i>	<i>5.70</i>	<i>Lobby</i>	<i>4.60</i>
<i>Parking Bays (covered/ basement)</i>	<i>1.10</i>	<i>Driveways (covered/ basement)</i>	<i>1.50</i>
<i>Electrical/Mechanical</i>	<i>3.50</i>	<i>Workshop</i>	<i>8.60</i>
Business			
<i>Enclosed</i>	<i>5.40</i>	<i>Open Plan</i>	<i>5.40</i>
<i>Banking Activity Area</i>	<i>5.80</i>	<i>Service/Repair</i>	<i>3.40</i>
Healthcare			
<i>Emergency</i>	<i>11.4</i>	<i>Recovery</i>	<i>4.40</i>
<i>Exam/Treatment</i>	<i>6.80</i>	<i>Storage</i>	<i>2.70</i>
<i>Nurses' Station</i>	<i>5.00</i>	<i>Laundry/Washing</i>	<i>3.80</i>
<i>Operating Room</i>	<i>10.9</i>	<i>Lounge/Recreation</i>	<i>4.60</i>
<i>Patient Room</i>	<i>3.80</i>	<i>Medical Supply</i>	<i>6.80</i>
<i>Pharmacy</i>	<i>5.30</i>	<i>Nursery</i>	<i>2.90</i>

<i>Physical Therapy</i>	4.90	<i>Corridor/Transition</i>	4.60
<i>Radiology/Imaging</i>	4.60		
Hospitality			
<i>Hotel Dining</i>	4.60	<i>Hotel Lobby</i>	5.50
<i>For Bar Lounge/ Dining</i>	7.00	<i>Motel Dining</i>	4.60
<i>For food preparation</i>	7.50	<i>Motel Guest Rooms</i>	3.80
<i>Hotel Guest Rooms</i>	4.60		
Shopping Complex			
<i>Mall Concourse</i>	6.40	<i>For Family Dining</i>	5.50
Category	LPD (W/m²)	Lamp category	LPD (W/m²)
<i>Sales Area</i>	9.20	<i>For food preparation</i>	7.50
<i>Motion Picture Theatre</i>	6.50	<i>Bar Lounge/ Dining</i>	7.00
Educational			
<i>Classroom/Lecture</i>	6.80	<i>Card File and Cataloguing</i>	4.60
<i>For Classrooms</i>	6.90	<i>Stacks (Library)</i>	9.20
<i>Laboratory</i>	7.50	<i>Reading Area (Library)</i>	5.70
Assembly			
<i>Dressing Room</i>	4.60	<i>Seating Area - Performing Arts Theatre</i>	11.3
<i>Exhibit Space – Convention Centre</i>	7.00	<i>Lobby - Performing Arts Theatre</i>	10.8
<i>Seating Area - Gymnasium</i>	3.40	<i>Seating Area – Convention Centre</i>	3.20
<i>Fitness Area - Gymnasium</i>	3.92	<i>Seating Religious Building</i>	8.20
<i>Museum – General Exhibition</i>	5.65	<i>Playing Area - Gymnasium</i>	6.50
<i>Museum – Restoration</i>	5.50		

6.3.4 Installed Interior Lighting Power

As per the Code,

The installed interior lighting power calculated for compliance with §6.3 shall include all power used by the luminaires, including lamps, ballasts, current regulators, and control devices except as specifically exempted in §6.1.

Exception to above,

If two or more independently operating lighting systems in a space are controlled to prevent simultaneous user operation, the installed interior lighting power shall be based solely on the lighting system with the highest power.

6.3.4.1 Luminaire Wattage

There are two aspects of a luminaire that has a direct impact on lighting energy consumption.

- 1) Wattage – This indicates the direct power consumption of the luminaire. Higher the wattage, more the electricity use. It also means that more luminaires would mean a higher total wattage and hence a higher connected lighting load.
- 2) Efficacy – Light output of a luminaire is given by 'lumens'. Higher the lumens, the “brighter” a lamp will appear. We want to select a luminaire that gives “more lumens per watt of electricity used”. **This is called lamp efficacy.**

$$\text{EFFICACY} = \text{LUMENS} / \text{WATT}$$

For example, a 6.5 watt LED lamp will give a similar light output to a 50 watt Halogen lamp. Thus, efficacy indicates how energy efficient a lamp is.

Thus, while selecting an energy efficiency lamp, it is essential to compare the efficacy and not just the wattage. All lamps have lumen rating mentioned on the package using which the efficacy can be derived. As per the Code,

Luminaire efficacy shall be 0.7 or above.

The Code requires that luminaire wattage be incorporated into the installed interior lighting power calculation as follows:

- (a) The wattage of incandescent luminaires with medium base sockets and not containing permanently installed ballasts shall be the maximum labeled wattage of the luminaires.

- (b) The wattage of luminaires containing permanently installed ballasts shall be the operating input wattage of the specified lamp/ballast combination. Operating input wattage can be either values from manufacturers’ catalogs or values from independent testing laboratory reports.
- (c) The wattage of all other miscellaneous luminaire types not described in (a) or (b) shall be the specified wattage of the luminaires.
- (d) The wattage of lighting track, plug-in busway, and flexible-lighting systems that allow the addition and/ or relocation of luminaires without altering the wiring of the system shall be the larger of the specified wattage of the luminaires included in the system or 135 Watt per meter (45 W/ft.). Systems with integral overload protection, such as fuses or circuit breakers, shall be rated at 100% of the maximum rated load of the limiting device

6.3.5 Exterior Lighting Power

As per the Code,

Connected lighting power of exterior lighting applications shall not exceed the lighting power limits specified in **Error! Reference source not found.** for ECBC Buildings, **Error! Reference source not found.** for ECBC+ Buildings and **Error! Reference source not found.** for SuperECBC Buildings. Trade-offs between applications are not permitted.

Table 6-7 Exterior Building Lighting Power for ECBC Buildings

<i>Exterior lighting application</i>	<i>Power limits</i>
<i>Building entrance (with canopy)</i>	<i>10 W/m² of canopied area</i>
<i>Building entrance (w/o canopy)</i>	<i>90 W/ linear m of door width</i>
<i>Building exit</i>	<i>60 W/lin m of door width</i>
<i>Building façade</i>	<i>5.0 W/m² of vertical façade area</i>
<i>Emergency signs, ATM kiosks, Security areas façade</i>	<i>1.0 W/m²</i>
<i>Driveways and parking (open/ external)</i>	<i>1.6 W/m²</i>
<i>Pedestrian walkways</i>	<i>2.0 W/m²</i>
<i>Stairways</i>	<i>10.0 W/m²</i>
<i>Landscaping</i>	<i>0.5 W/m²</i>
<i>Outdoor sales area</i>	<i>9.0 W/m²</i>

Table 6-8 Exterior Building Lighting Power for ECBC+ Buildings

<i>Exterior lighting application</i>	<i>Power limits</i>
<i>Building entrance (with canopy)</i>	<i>8.0 W/m² of canopied area</i>
<i>Building entrance (w/o canopy)</i>	<i>72 W/ linear m of door width</i>
<i>Building exit</i>	<i>48 W/lin m of door width</i>
<i>Building façade</i>	<i>4.0 W/m² of vertical façade area</i>
<i>Emergency signs, ATM kiosks, Security areas façade</i>	<i>0.8 W/m²</i>
<i>Driveways and parking (open/ external)</i>	<i>1.3 W/m²</i>
<i>Pedestrian walkways</i>	<i>1.6 W/m²</i>
<i>Stairways</i>	<i>8.0 W/m²</i>
<i>Landscaping</i>	<i>0.4 W/m²</i>
<i>Outdoor sales area</i>	<i>7.2 W/m²</i>

Table 6-9 Exterior Building Lighting Power for SuperECBC Buildings

<i>Exterior lighting application</i>	<i>Power limits</i>
<i>Building entrance (with canopy)</i>	<i>5.0 W/m² of canopied area</i>
<i>Building entrance (w/o canopy)</i>	<i>45 W/ linear m of door width</i>
<i>Building exit</i>	<i>30 W/lin m of door width</i>
<i>Building façade</i>	<i>2.5 W/m² of vertical façade area</i>
<i>Emergency signs, ATM kiosks, Security areas façade</i>	<i>0.5 W/m²</i>
<i>Driveways and parking (open/ external)</i>	<i>0.8 W/m²</i>
<i>Pedestrian walkways</i>	<i>1.0 W/m²</i>
<i>Stairways</i>	<i>5.0 W/m²</i>
<i>Landscaping</i>	<i>0.25 W/m²</i>
<i>Outdoor sales area</i>	<i>4.5 W/m²</i>

6.3.6 Controls for ECBC+ and SuperECBC Buildings

6.3.6.1 Centralized Controls

Centralized lighting control can increase the potential of energy savings during operations by offering superior control. Such a lighting control system is usually part of the Building Management System (BMS). From one location, the lighting in a single room to a group of rooms or even the entire building can be controlled.

Lighting control systems can be a hard wired or a wireless system. It requires thorough planning during the design development stage in order to have a successful lighting control system in place.

As per the Code,

ECBC+ and SuperECBC building shall have centralized control system for schedule based automatic lighting shutoff switches.

6.3.6.2 Exterior Lighting Controls

Lighting for all exterior applications, shall have lamp efficacy not less than 80 lumens per watt, 90 lumens per watt, and 100 lumens per watt, for ECBC, ECBC+, and SuperECBC Buildings respectively, unless the luminaire is controlled by a motion sensor or exempt under §6.1.

Example 6-A

A four-story building has retail on the ground floor and offices on the top three floors. Area is 3,600 m². Space types and their respective areas are mentioned below. Calculate the interior lighting power allowance using the space function method for a ECBC building. What will be the exterior lighting power allowance for façade lighting for this building?

Answer:

For each of the space type, corresponding Lighting Power Density (LPD) values for Business and Shopping complex building type from Table 6-4 are used. Area is multiplied with the LPD values to estimate the lighting power allowance for the whole building as shown below.

Space Function	LPD (W/ m ²)	Area (m ²)	Lighting Power Allowance (W)
Office			
Office - enclosed	10.0	720	7,200
Office – open plan	10.0	1,485	14,850
Meeting Rooms	11.5	120	1,380
Lobbies	7.1	93	660
Restrooms	7.7	51	393
Corridors	7.1	125	887.5
Electrical/ Mechanical	7.1	14	99
Staircase	5.5	84	462
<i>Total</i>			25,931.5
Retail			
General sales area	18.3	669	12,243
Offices - enclosed	10.0	28	280
Restrooms	7.7	9	69
Corridors	7.1	79	561
Active Storage	6.8	93	632
Food preparation	12.1	28	339
<i>Total</i>			14,124
Building Total			40,055.5 W

Thus, total lighting power allowance for this building is 40kW.

From **Error! Reference source not found.**, it can be determined that the exterior building lighting power limit for façade lighting is 5.0 W/m² of vertical façade area.

7 Electrical & Renewable Energy Systems

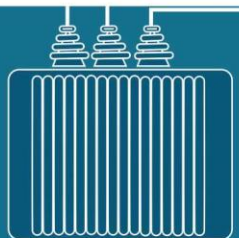
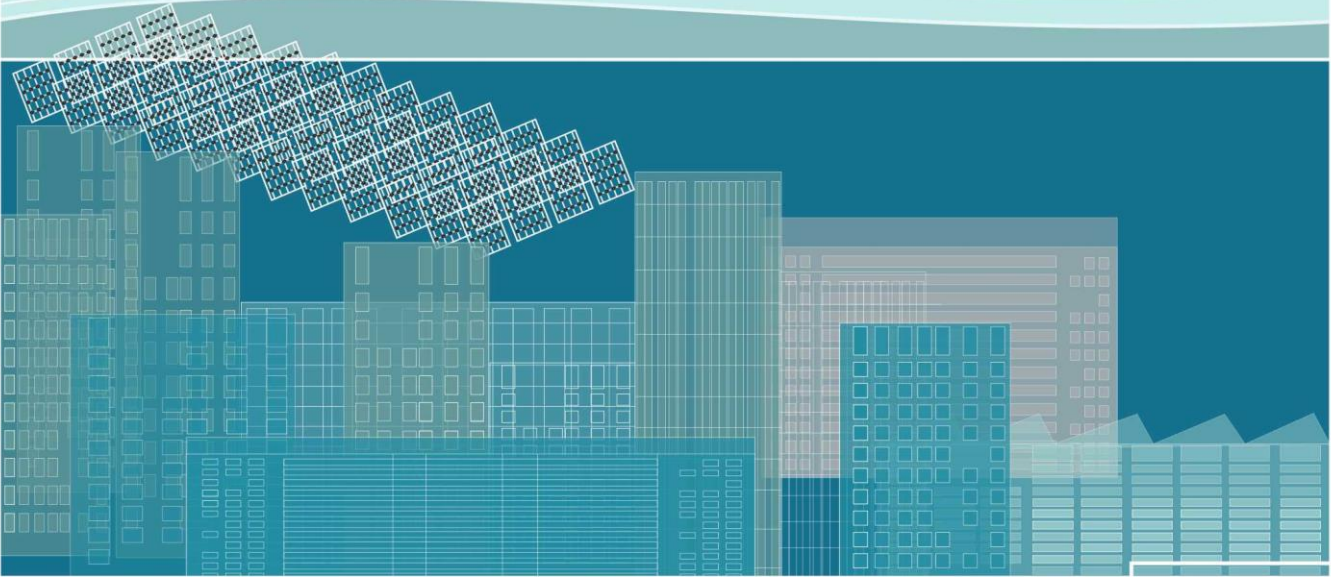
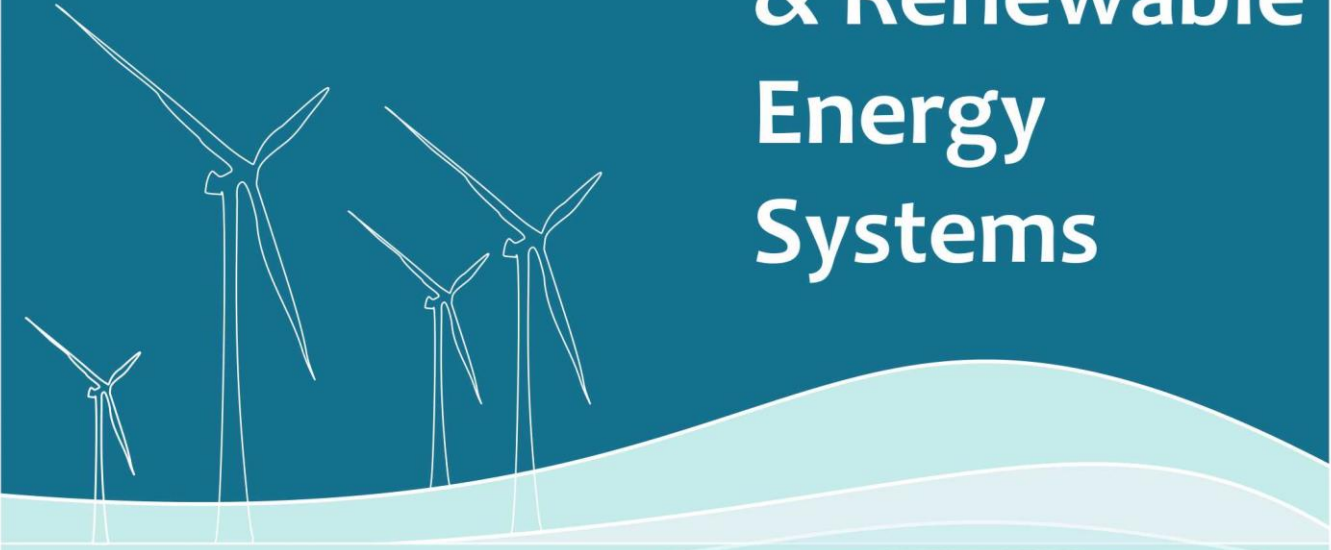

ELECTRICAL AND RENEWABLE ENERGY SYSTEMS

INTENT

After optimizing the loads in the buildings, the final step is to ensure that the electrical systems are designed efficiently to ensure that the overall system is minimizing distribution losses and supplies electricity efficiently to the building. Further, renewable energy can be used as a potential source of electricity (clean energy). Hence requirements to ensure buildings are ready to integrate renewable system in the future have been covered in this chapter. This will prepare the building industry to move towards self-sufficiency and clean energy.

SECTION ORGANIZATION

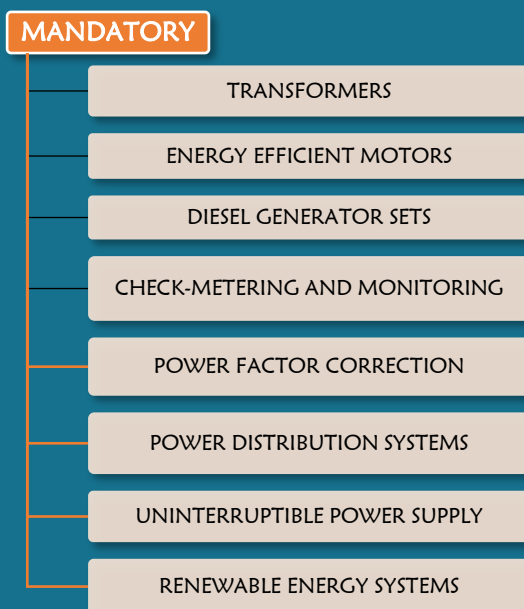

7. ELECTRICAL AND RENEWABLE ENERGY SYSTEMS

7.1 General

Electricity is integral to our lives and determines how we live today. Most modern buildings today are completely dependent on electricity for normal operations. Hence it is important that designers must be familiar with the basic concepts and equipment of regular electrical systems.

Efficient use of power supplied to a building depends directly on how the electrical system is designed. Maximizing the efficiency of electrical systems in use will minimize losses (in the form of waste heat, noise, or vibration), and maximize the useful output of the input power.

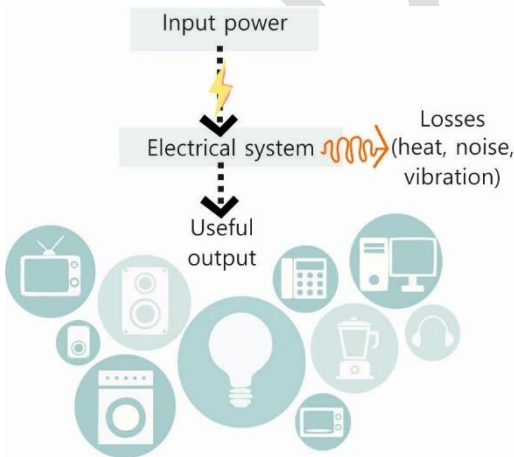

Figure 7.1 Function of electrical system

Electricity is produced most often in a power plant by burning fossil fuel such as coal or oil. The resultant heat is then used to create another usable form of energy – electricity. It is important to remember that, in terms of consumption of

natural resources, electricity is an expensive form of energy because the efficiency of the overall heat-to-electricity conversion, on a commercial scale, rarely exceeds 40% (Grondzik et al. 2010). Electricity produced at the power plant is then sent to the local utilities through power transmission lines which further results in some loss of energy.

Key concepts and units

Ampere measures electric *current*. Current is the measure of the flow of electricity which is comparable to water flow in a hydraulic system. Denoted by I

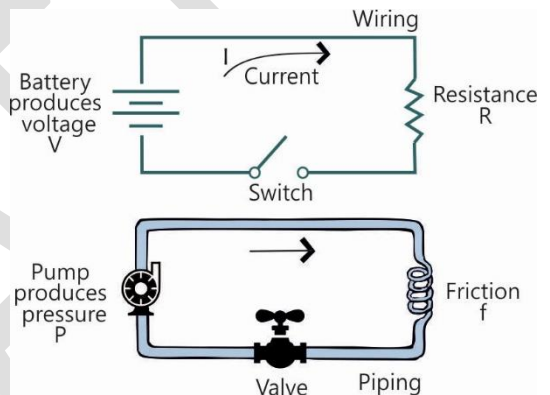

Figure 7.2 Analogy between electrical and hydraulic system

Volt measures electric *potential*. Electricity is fundamentally the movement of electrons through a conductor like a wire. This movement is triggered by the difference in the charge (positive and negative) created on either ends of the conductor. Voltage can be compared to a pump in a hydraulic system. Just as the pressure produced by a pump causes water to flow in a pipe, the potential (voltage) produced by a battery or a generator causes current to flow in a conductor connecting the terminals between which a voltage exists. The higher the voltage, the higher the current for a given resistance. The unit of voltage is Volt, denoted by V or v .

Ohm measures electric *resistance*. Just like the flow of water in a hydraulic system is resisted by friction, flow of current in an electric circuit is also resisted. In a DC (direct current) circuit, it is called *resistance* and is abbreviated *R*; in AC (alternating current) circuit it is called *impedance* and is abbreviated *Z*. Units of resistance is *Ohm* and symbol is Ω

Ohm’s Law states that current *I* flowing in the electric circuit is proportional to the voltage *V* and inversely proportional to the resistance *R*. It is expressed in the following equation

$$I = \frac{V}{R} \quad \text{..... Equation 7A}$$

Thus, current flow increases if resistance decreases and voltage increases. Ohm’s Law holds true for both AC and DC circuits. For an AC circuit, Ohm’s Law is given by

$$I = \frac{V}{Z} \quad \text{..... Equation 7B}$$

Where *Z* is the symbol for impedance in ac circuits. Depending on the circuit load, impedance can be markedly different from the DC resistance which is discussed further in *Power Factor*.

Metals such as gold, silver, copper and aluminum offer least resistance and hence are called conductors. That’s why electric wires are often made of copper. Whereas, materials like glass, rubber, plastic and porcelain resist the flow of current and hence are called insulators. That’s why rubber and plastic are commonly used as wire coverings; and melamine for plug sockets and switches.

Direct and alternating current

Electricity flows in two ways: either in a direct current (DC) or an alternating current (AC). The difference lies in the direction in which the electrons flow. In a DC circuit, electrons flow steadily in a single direction, or “forward”. In AC,

electrons keep switching directions, sometimes going “forward” and then going “backward”(Figure 7.3).

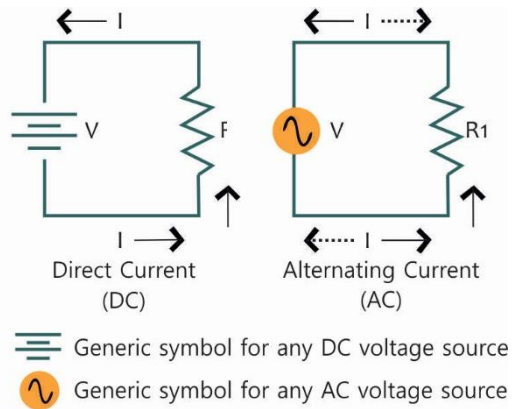

Figure 7.3 Direct and alternating current

The foundation of electricity generation is based on Michael Faraday’s law of electromagnetic induction which states - *when an electrical conductor is moved in a magnetic field, a voltage is induced in the conductor.*

A magnetic field near a wire causes the electrons to move in a single direction because they are repelled by the negative side of a magnet and attracted toward the positive side. This is called direct current. An ordinary dry cell supplies direct current where the positive and negative terminals are always fixed. When the terminals of a 1.5V battery are connected, electricity starts flowing from the positive to the negative side in a single direction at a constant voltage. The device of the equipment that produces the DC is called a DC generator.

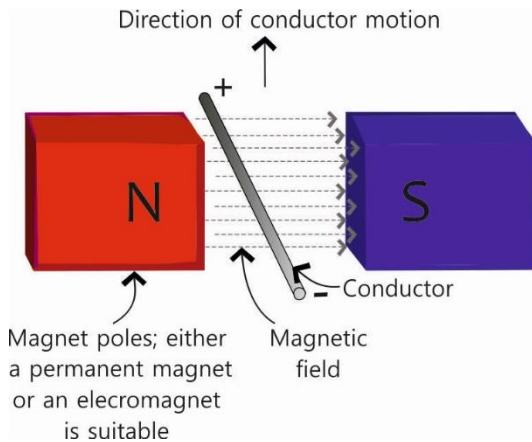

Figure 7.4 DC generator operation

When the magnet around the conductor is rotated, it produces alternating current. When the magnet is oriented in one direction, the electrons flow towards the positive, but when the magnet's orientation is flipped, the movement of electrons turn as well. An AC generator is called an *alternator* because it produces alternating current (Figure 7.5).

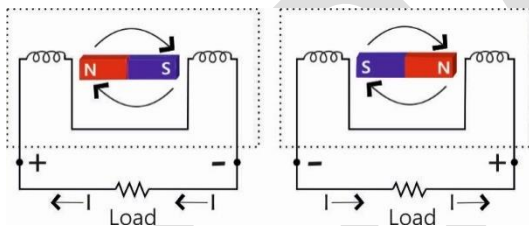

Figure 7.5 Alternator operation

In an AC circuit, the flow of current periodically varies in time which is represented as a sine wave as shown in Figure 7.6. The distance along the time axis spanned by a positive and a negative AC loop is called *one cycle*. The number of such cycles occurring in 1 second is known as the *frequency* of the AC current. Normal AC generator frequency is 50Hz in India. Most appliances and equipment used in buildings are designed to operate at 230V and 50Hz.

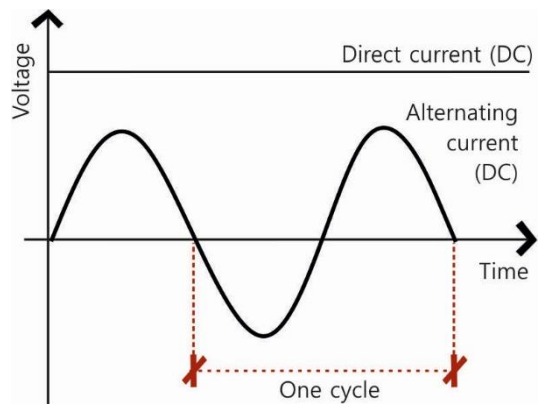

Figure 7.6 DC and AC representation

AC current is commonly used for most commercial applications. DC works well for a portable device like a battery. The common electrical plug sockets is supplied with AC current at 230V. AC can even be changed to DC. For example, a laptop or desktop computer uses a small transformer to convert the AC to DC direct current. On the other hand, DC can also be changed to AC, it is just a little more difficult. For example, inverters that provide power back up change DC to AC.

Where and why is AC used

All over the world, electrical energy is distributed as alternating current because AC voltage may be increased or decreased using a transformer. It is significantly cheaper to produce and transmit electricity in AC format rather than DC.

Power plants produce millions of Watts of power. Transmitting millions watts at low voltage will mean using thicker wire which is cost prohibitive considering the thousands of kilometers that the transmission lines travel. However, transmitting fewer watts through millions of voltage requires a thin wire which is what AC allows and it has many advantages. Firstly, the energy lost as heat due to the resistance of the wire is significantly less in a thin wire. Secondly, higher the voltage, faster the electrons can travel. Whereas in the case of DC,

a single voltage cannot transmit power very far until it begins to lose energy.

Hence power companies produce AC at a convenient voltage as per the design of the alternator, then increase it to very high voltages for transmission (such as 1 million volts), then drop it back down to lower voltages for distribution (such as 1,000 volts), and finally down to 230 volts inside the building for safety.

While DC can be stored in batteries, AC cannot be stored. Electricity as AC need to be produced as it is used. Power grids supply AC at high voltage as per the demand

Power and Energy

It is critical and useful to understand the distinction between power and energy. More often these terms are used interchangeably, which is incorrect and can lead to bad design decisions.

Energy is the technical term for the expression *work done*. Power is the *rate at which energy is used*. The concept of power necessarily involves the factor of time. It is expressed as

$$\text{Energy (work)} = \text{power} \times \text{time}$$

Energy can be converted from one form to another. For example, a battery converts chemical to electrical energy; a turbine converts mechanical to electrical energy. Energy produced can also be stored in different forms. For example, thermal energy can be stored in form of ice. But power cannot be transformed or stored.

Energy is expressed as kilowatt-hours. Power is expressed as watts or kilowatts. Many equipment and appliances have power rating mentioned in the technical specifications. For example, a 10W light bulb or a 2000W electric geyser. Sometimes, IP units can also be used. For example, power rating of motors is commonly

expressed in horsepower which is the IP unit system.

$$1000 \text{ W} = 1 \text{ kilowatt or } 1\text{kW}$$

$$1 \text{ HP} = 746 \text{ watts}$$

Example 7-A

A 10-Watt light bulb is being used for 100 hours. What is total energy use of the lamp and what is the power rating?

Answer:

The power rating of the light bulb is 10W. The rate at which this power will be used will determine the energy use.

$$\text{Energy used} = \text{power} \times \text{time}$$

$$= 10 \times 100 = 1000 \text{ watt-hours or } 1\text{kWh}$$

(Note: This is a simplified example to explain the concept. The actual energy use should take into account voltage and current as discussed in the further section)

Power in electric circuits

In electric circuits, power is a function of both voltage and current. Remember that voltage is the specific work (or potential energy) per unit charge, while current is the rate at which electric charges move through a conductor. Voltage (specific work) is analogous to the work done in lifting a weight against the pull of gravity. Current (rate) is analogous to the speed at which that weight is lifted. Together as a product (multiplication), voltage (work) and current (rate) constitute power.

ELECTRICAL POWER IS A PRODUCT OF BOTH VOLTAGE AND CURRENT

It must be understood that neither voltage nor current by themselves constitute power. A circuit with high voltage and low current may be dissipating the same amount of power as a circuit with low voltage and high current. Therefore, power is the combination of both voltage and current in a circuit.

The general equation for power is given by

$$P = I^2R \dots\dots\dots \text{Equation 7C}$$

Where,

P = power input in terms of Watts

I = current measured in Amperes

R = Resistance measured in Ohms

This is an important fundamental equation that is used to determine other aspects such as voltage drop and power loss in electric design.

Resistance in circuits

Resistance is the easiest variable to control in any circuit. The generic symbol for resistance is shown in Figure 7.7.

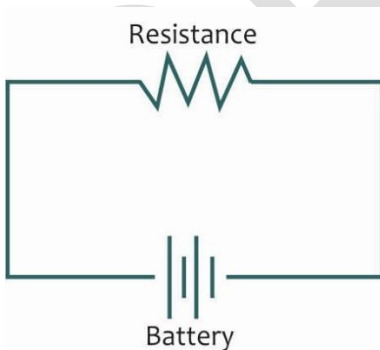

Figure 7.7 Simple representation of electric circuit

Devices called ‘resistors’ are commonly used in electronic circuit boards. Although it may seem pointless to have a device doing nothing but resisting electric current, resistors are extremely useful devices in circuits.

Resistor is a device that is doing something useful with the electrical energy. When current flows through the resistor, it generates some heat as output due to resistance. This heat is given in watts as per the Power equation ($P = I^2R$). The larger the resistor, the more power it can safely dissipate without resulting in damage. Thus, resistors are rated both in terms of their resistance (ohms) and their ability to dissipate heat energy (watts).

Example 7-B

A 15 volt battery is connected to a circuit that has 3Amp current. Calculate the resistance on this circuit.

Answer:

Using the Ohm’s Law equation,
 $I = V/R$

Resistance $R = \text{voltage} / \text{ampere} = 15/3$
 Thus, $R = 5 \text{ Ohms or } 5\Omega$

Using the power equation, we can calculate the heat dissipation. Since this is a purely resistive circuit, the power equation for AC and DC will be the same as follows

$$P = VI$$

Thus, $P = 15 \text{ V} \times 3 \text{ A} = 45 \text{ watts}$

Thus, for this circuit design we need to specify a resistor with a minimum power rating of 45 watts, or else it would overheat and fail.

In a building’s electrical system, the term ‘load’ is appropriately used instead of a resistor. Any device that performs some useful task with electric power is generally known as a load. Building loads can be connected lighting, cooling equipment, appliances and so on. These *connected loads* determine how much power is

required in the electrical circuit and accordingly the wiring and layouts are designed.

Power factor

Loads can draw **resistive or reactive power**. For example, an incandescent lamp draws energy to convert to heat and hence is referred to as drawing resistive power. All the electrical Watts is converted to useful work as heat energy in Watts. These are called resistive loads. Whereas an induction motor, for example, draws power to convert to useful mechanical output as well as draws power to generate the magnetic field required to perform its desired function. This is called reactive power which can be considered as magnetising or wasted power since the magnetizing current does not contribute to the work output of the motor.

The reactive power drawn by an inductive load causes a phase difference between voltage and current that is given by an angle as shown in Figure 7.8. **The cosine of this angle is called the Power Factor (pf).**

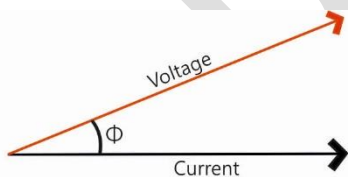

Figure 7.8 Phase difference due to reactive power

Thus, the useful power (or real power) and the reactive power has to be factored in to determine the total power (or apparent power) used by the motor.

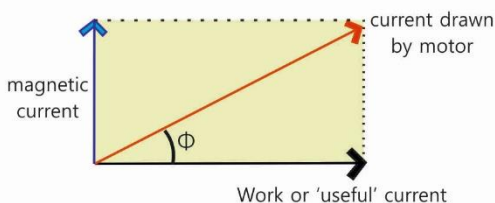

Figure 7.9 Reactive power by inductive load

Using Ohm's Law from equation 7B, $V = IR$, the power equation for DC circuits is given by

$$P = I.(IR) = VI \dots\dots\dots \text{Equation 7D}$$

Where,

P = Power in Watts

V = Voltage in Volts

I = Current in Amperes

As discussed earlier, resistance in an AC circuit is called impedance which is slightly different from DC circuit. Impedance is a combination of DC resistance and AC resistance (called *reactance*). Reactance is accounted by the *Power Factor (pf)*.

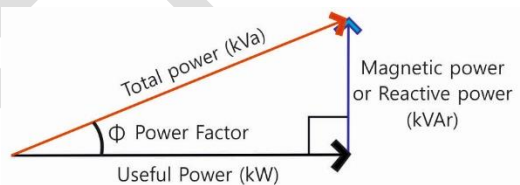

Figure 7.10 Power Factor

Thus, in AC circuits, the power equation incorporates *power factor* which is given by

$$P = VI \times pf \dots\dots\dots \text{Equation 7E}$$

In terms of units,

$$\text{Watts} = \text{Volt.Ampere (VA)} \times pf$$

Hence, Power Factor can be expressed as

$$pf = \frac{P}{VI}$$

$$\text{power factor} = \frac{kW}{kVA}$$

$$\cos \theta = \frac{kW (\text{useful power})}{kVA (\text{total power})} \dots\dots \text{Equation 7F}$$

Power Factor is a measure of how efficiently electrical power is converted into useful work output. The ideal power factor is unity, or one. Anything less than one means that extra power is required to achieve the actual task at hand.

Power factor is a very important term that enables to calculate the actual power in AC circuits.

Example 7-C

The nameplate of a single-phase motor shows the following data: 2HP, 230 V, AC, 17A. Assume an efficiency of 90%. Calculate the motor (and therefore circuit) power factor.

$$1 \text{ HP} = 746 \text{ watts}$$

Answer:

Power rating of the motor

$$2 \text{ HP} = 2 \times 746 = 1492 \text{ watts}$$

This is the power output of the motor.

Now, Efficiency = output/input

$$\text{Thus, Power Input} = 1492/0.9 = 1657 \text{ W}$$

Using power equation for AC circuit,
 $P = \text{Volt} \times \text{ampere} \times \text{power factor}$

$$1657 = 230 \times 17 \times \text{power factor}$$

$$\text{Thus, power factor} = 0.42$$

Note:

Notice the large difference between volt-amperes and Watts

$$V \times I = 230 \times 17 = 3910 \text{ VA}$$

$$P (\text{power}) = 1657 \text{ Watts}$$

This difference is an important consideration for circuit design and sizing different circuit components.

A load with a power factor of 1.0 results in the most efficient loading of the supply. A load with a power factor of, say, 0.8, results in much higher losses in the supply system and a higher bill for the consumer.

In commercial buildings, majority of the loads are inductive such as induction motor, a power transformer, a ballast in a luminaire, a welding set or so on. Hence, the resulting reactive power tend to reduce the power factor. Consequently, a power factor correction is required which is discussed in §7.2.5.

Energy in electric circuits

Energy is the power used over a certain time. Since the units of power is Watts and time is hours, the units of energy is Watt-hour or kilowatt-hour (kWh).

1 kWh is commonly referred to as 1 unit. If you observe the electricity bill, the total number of units is tabulated which is the total kWh of energy used by the facility.

Example 7-D

Find the daily energy consumption of the equipment listed if they are used for the length of time shown.

Split AC (3500 W) – 5 hrs

Coffee maker (500 W) – 6 hrs

Computer (75 W) – 12 hrs

Microwave (1000 W) – 2hrs

Answer:

Split AC

$$3500 \text{ W} = 3.5 \text{ kW} \times 5 = 17.5 \text{ kWh}$$

Coffee maker

$$500 \text{ W} = 0.5 \text{ kW} \times 6 = 3 \text{ kWh}$$

Computer

$$75 \text{ W} = 0.075 \text{ kW} \times 12 = 0.9 \text{ kWh}$$

Microwave

$$1000 \text{ W} = 1 \text{ kW} \times 2 = 2 \text{ kWh}$$

Total daily energy consumption
= 23.4 kWh

Types of electrical circuits

There are two types of circuit arrangements – series and parallel. While the concept remains same for both AC and DC, circuit calculations are different.

Series circuit

In a series circuit, the elements are connected one after another, i.e. in series (Figure 7.11). Which means the voltage and resistances add up. In a series arrangement, the current is the same in all parts of the circuit because electrons are moving in a single loop. Whereas, voltage could be different across resistances.

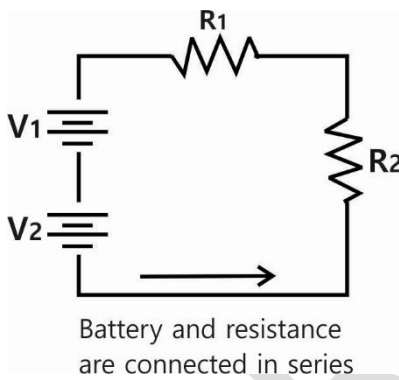

Figure 7.11 Series circuit arrangement

For the circuit shown in Figure 7.11, total resistance will be $R_1 + R_2$ and total voltage will be $V_1 + V_2$. The wire itself also offers some resistance, but that is usually very small compared to the resistance by the load. Hence it is not included in calculations.

All components in a series circuit should function for the circuit to be complete. Series circuit find limited application in buildings, because failure of any one load (such as burned out lamp) will break the circuit resulting in a power shut down to the remaining loads.

Example 7-E

A 10 Volt battery is connected in series with two resistances. $R_1 = 2$ Ohms and $R_2 = 6$ Ohms. Determine (a) the current flowing in the circuit and (b) the voltage drop across the resistance R_1 .

Answer:

Total current in the circuit is
 $R_1 + R_2 = 2 + 6 = 8$ Ohms

(a) Current flowing in the circuit
Using Ohm's Law,
 $I = V/R = 10/8 = 1.25$ Amps

(b) Voltage drop across the load
Using Ohm's Law,
 $V = I \times R = 1.25 \times 2 = 2.5V$

Note that 10 V is the voltage applied to the entire circuit and at each resistor, there will be a voltage drop. The voltage drop at R_2 will be 7.5V. Thus, supply voltage is equal to the sum of the individual voltage drops. But the total current will be the same.

Parallel circuit

In a parallel circuit, two or more branches with loads are connected to the same point (Figure 7.12). Current gets distributed in each branch as per the load while the voltage across each load in different branches stays the same. Thus total current in the circuit is the sum of individual branch currents.

Unlike the series circuit, individual resistances in a parallel circuit *diminish* rather than *add* up to make the total. In a parallel circuit, total resistance is calculated as

$$R_{total} = \frac{1}{\frac{1}{R_1} + \frac{1}{R_2}}$$

Whereas, total current is calculated as

$$I_{total} = I_1 + I_2$$

resistance are connected in parallel

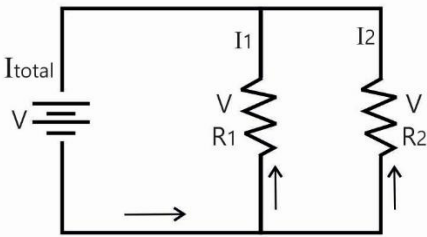

in effect, this parallel circuit is the same as two separate circuits combined into a single circuit shown below

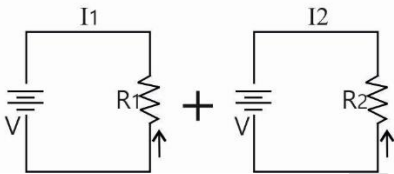

Figure 7.12 Parallel circuit arrangement

As shown in Figure 7.12, there are several closed circuits with a parallel arrangement. If the load R1 fails, the circuit will still be functioning. Parallel circuit is the standard practice in all building wiring. For example, in a room, the lighting will be on one circuit and the receptacles will be on another circuit. All of which will be connected to one junction box outside the room. There can be parallel circuit for lighting as well in

the same space which will ensure one circuit will be working if another circuit breaks.

IN A SERIES CIRCUIT: CURRENT THROUGH EACH COMPONENT IS SAME. CIRCUIT VOLTAGE IS THE SUM OF VOLTAGE ACROSS EACH COMPONENT.

IN A PARALLEL CIRCUIT: VOLTAGE ACROSS EACH COMPONENT IS SAME. CIRCUIT CURRENT IS THE SUM OF INDIVIDUAL BRANCH.

Let's look at an example to understand the circuit arrangement better. Figure 7.13 shows the electrical wiring for a typical classroom. Observe that the lighting and fans are on separate circuits. Some of the lights are connected in series. For example 'Lighting series 1' has two lights connected in series. All the individual series are connected to the same switch board. Thus, there are 4 parallel circuits for lighting. All fans are individually connected directly to the switchboard. This means, if one of the fans fails, the other will still be working. It is also possible to connect fans in series. But in this example, there are 9 parallel circuits for the fans which provides better user control.

all fans are individually connected to the switch board. Thus, all fans are on an independent circuit

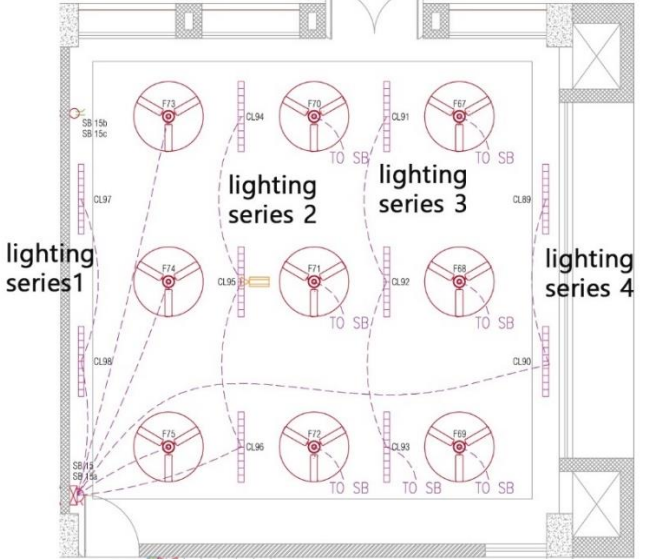

Figure 7.13 Sample electrical layout for a classroom

Building electrical system

The main components of the electrical system in a commercial building are shown in Figure 7.14. Fundamentally, there are two part to the entire electrical system – supply side and demand side.

Supply side

This section includes all the components until that bring useable electricity until the main distribution board or the main electric panel which is the point of entry to the building. Electricity supply is usually from the local utility which is also commonly referred as *the grid* which means *electric grid*. This high voltage supply is fed into the transformer which steps down the voltage that can be used in the building. In areas that encounter frequent power failures, provision for power back up is provided in the form of Diesel Generator set (DG set). Thus, DG set is the main supply in case of unavailability of power. Further, on-site renewable energy systems such as solar photovoltaic could be used to produce

electricity. These systems are also considered as supply side components producing DC which is converted to AC by an inverter and then supplied to the main distribution board.

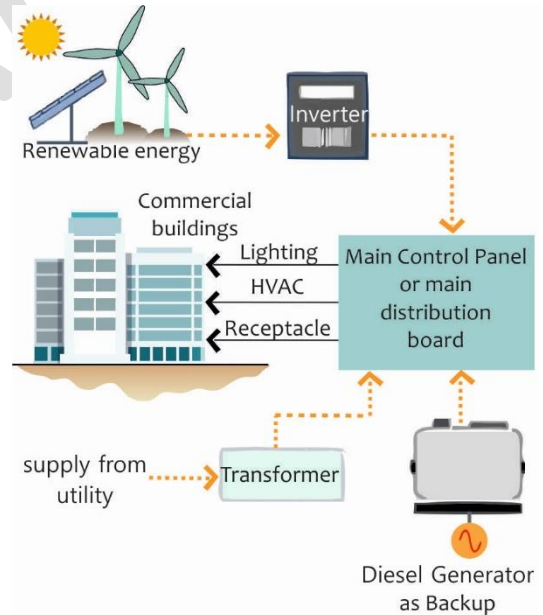

Figure 7.14 Electrical system of a commercial building

Demand side

This section includes all components inside the building that *utilize electricity* such as lighting, HVAC, receptacles and so on. There are also referred to as *loads* as discussed earlier. The design of the supply equipment depends on the loads and loads are a result of building design including the envelope and comfort systems. Good building design will reduce the thermal as well as electrical loads. This is key to achieve energy efficiency.

ECBC has requirements for both supply and demand side of the electrical system.

7.2 Mandatory Requirements

All requirements in §7 of the ECBC is mandatory and must always be met even the Whole Building Performance Method of compliance is used.

7.2.1 Transformers

Transformer has made long range electric power distribution practical. Transformer is an equipment that steps the voltage up or down. It only works with AC supply and not with DC. Transformers can be pole-mounted or pad-mounted on the ground. It is common practice to install transformer outside the building, but it can be installed inside as well.

Substation or power transformers are large and are always concrete-pad-mounted (Figure 7.15). They are used in transmission of higher voltages, deployed for step-up and step-down transformer application (400 kV, 200 kV, 110 kV, 66 kV, 33kV).



Figure 7.15 Sub-station transformer

Distribution transformers are used to lower down the voltage in distribution networks for end user application (11kV, 6.6 kV, 3.3 kV, 440V, 230V). It could be mounted on a pole or on a concrete pad outdoors (Figure 7.16).



Figure 7.16 Pole-mounted distribution transformer

Working principle

Transformers work on the principle of mutual induction similar to the concept of magnetic induction. It consists of an iron core around which coils are wound. The current flowing in

one coil induces a voltage in the adjacent coil in proportion to the ratio of turns in the two coils. Primary coil is the one connected to the AC power supply from the grid. Secondary coil is connected to the load supplied to the building. Thus, a *step-down* transformer has a larger number of turns in its primary winding than in its secondary winding, and a *step-up* transformer has the reverse.

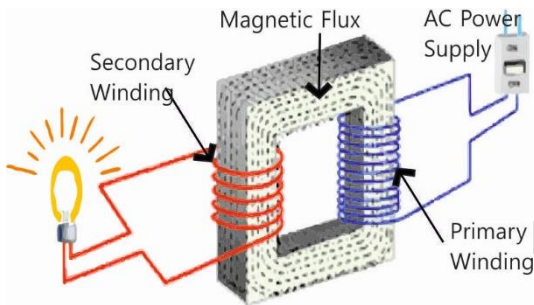

Figure 7.17 Transformer working principle

The amount of mutual inductance that links one coil to another depends very much on the relative positioning of the two coils and also the number of turns in each coil.

Transformers are available in single-phase or three-phase construction. Transformer power capacity is rated in kilovolt-amperes (kVA).

TRANSFORMERS ARE USED TO STEP THE VOLTAGE UP OR DOWN

Heat is generated by the passage of current through the transformer coils due to the resistance. This heat is transferred to the unit's cooling medium. There are two types of transformers based on the cooling medium.

1. Liquid-immersed transformers
2. Dry-type transformers

Liquid-immersed transformers

In this type, oil is used for insulation as well as coolant purpose to dissipate heat generated in

core of the transformer. Hence these are also called as oil-filled transformers.

Dry-type transformers

In dry type transformer, windings with core are kept within a sealed tank that is pressurized with air. These are relatively lighter in weight and easier to maintain. Dry transformers are preferred in the places like hotels, hospitals, shopping malls where fire safety is very important.

Insulation

Heat loss occurring in the transformer can cause increase in the temperature of the equipment. The *insulation class* of a transformer affects its permissible temperature rise and operating temperature,

and, as a direct result, its physical size, electrical power losses, overload capacity, and life.

7.2.1.1 Maximum Allowable Power Transformer Losses

Majority of the energy loss in the transformer occurs due to the heat generated in the core. To reduce these losses electrical distribution transformers are made of amorphous metal core which provides excellent opportunity to conserve energy right from installation. The amorphous material has unique physical and magnetic property that helps in reducing core loss of transformers. The efficiency of amorphous core transformer could reach up to 98.5% at 35% load. These transformers are costlier than conventional transformers. Conventional transformers are simple in construction but incur core losses are around 70% more than amorphous core transformers.

In distribution system, major losses occur due to long distance between the transformer and load. There will be frictional losses depending on the length and thickness of the electrical wire.

Hence, transformer is placed near the loads to reduce the length of wire and minimizing losses.

Transformer efficiency also depends on the operating load. Transformer losses consist of two parts: No-load Loss and Load Loss

No-load Loss (also called core loss) is the power consumed to sustain the magnetic field in the transformer's steel core. Core loss occurs whenever the transformer is energized; and it does not vary with load. Core losses are caused by two factors: hysteresis and eddy current losses. Hysteresis loss is that energy loss caused by reversing of the magnetic field in the core as the magnetizing alternating current rises and falls and reverses direction. Eddy current loss is a result of induced currents circulating in the core.

Load Loss (also called copper loss) is associated with full-load current flow in the transformer windings. Copper loss is power lost in the primary and secondary windings of a transformer due to the ohmic resistance of the windings. Copper loss varies with the square of the load current. ($P=I^2R$). Transformer losses as a percentage of load is given in

By considering both the losses, total transformer losses can be computed with the help of following formula:

$$P_{TOTAL} = P_{NO-LOAD} + (\% \text{ Load}/100)^2 \times P_{LOAD}$$

$$\% \text{ Load} = (\text{kVA}_{\text{Load}} / \text{Rated kVA})$$

As per the Code,

Power transformers of the proper ratings and design must be selected to satisfy the minimum acceptable efficiency at 50% and full load rating.

Permissible total loss values shall not exceed

- (a) 5% of the maximum total loss values mentioned in IS 1180 for oil type transformers in voltage class above 11 kV but not more than 22 kV
- (b) 7.5% of the maximum total loss values mentioned in above IS 1180 for oil type transformers in voltage class above 22 kV and up to and including 33 kV
- (c) Dry type transformers should meet requirements as per IS code 1117

Figure 7.18.

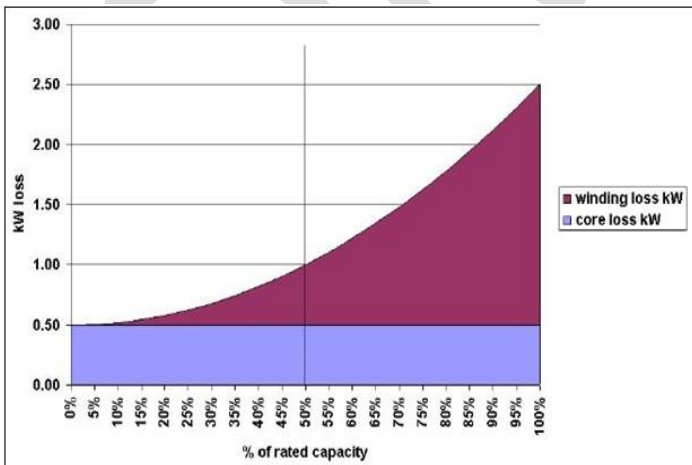

Figure 7.18 Transformer losses²

Table 7-1 Dry Type Transformers

Standard Ratings for Three Phase Dry Distribution Transformer upto and including 200 kVA (Clause xx)		
S. No. (1)	Nominal System Voltage (2)	Standard Ratings (kVA) (3)
i)	Up to and including 11 kV	*6.3, *10,16, *20, 25, *40,63, 100, 160 and 200
ii)	Above 11 kV up to and including 22 kV	63, 100, 160 and 200
iii)	Above 22 kV up to and including 33 kV	100, 160 and 200

NOTE – * ratings are non-preferred

Standard Ratings for Three Phase Dry Distribution Transformer above 200 kVA upto and including 2500 kVA (Clause xx)		
SI No. (1)	Nominal System Voltage (2)	Standard Ratings (kVA) (3)
i)	Up to and including 11 kV	250, 315, 400, 500, 630, 1000, 1250, 1600, 2000 and 2 00
ii)	Above 11 kV up to and including 22 kV	250, 315, 400, 500, 630, 1000, 1250, 1600, 2000 and 2500
iii)	Above 22 kV up to and including 33 kV	250, 315, 400, 500, 630, 1000, 1250, 1600, 2000 and 2500

Standard Ratings for Single Phase Dry Type Transformer upto and including 25 kVA (Clause xx)	
Nominal System Voltage	Standard Ratings (kVA)
11 kV	5,10,16 & 25
22 kV	10,16 & 25
33 kV	16 & 25

Source: BEE

² Energy Efficiency in Electrical Utilities, Bureau of Energy Efficiency, 2005.

Table 7-2 Permissible Losses for Oil Type Transformers. Total losses for oil type transformers shall confirm with Indian Standard IS 1180.

Rating (kVA)	Impedance (%)	Max. Total Loss (W)					
		ECBC Building		ECBC+ Building		SuperECBC Building	
		50 % Load	100% Load	50 % Load	100% Load	50 % Load	100% Load
16	4.5	150	480	135	440	120	400
25	4.5	210	695	190	635	175	595
63	4.5	380	1250	340	1140	300	1050
100	4.5	520	1800	475	1650	435	1500
160	4.5	770	2200	670	1950	570	1700
200	4.5	890	2700	780	2300	670	2100
250	4.5	1050	3150	980	2930	920	2700
315	4.5	1100	3275	1025	3100	955	2750
400	4.5	1300	3875	1225	3450	1150	3330
500	4.5	1600	4750	1510	4300	1430	4100
630	4.5	2000	5855	1860	5300	1745	4850
1000	5	3000	9000	2790	7700	2620	7000
1250	5	3600	10750	3300	9200	3220	8400
1600	6.25	4500	13500	4200	11800	3970	11300
2000	6.25	5400	17000	5050	15000	4790	14100
2500	6.25	6500	20000	6150	18500	5900	17500

Total loss values given in above table are applicable for thermal classes E, B and F and have component of load loss at reference temperature according to Clause 17 of IS 1180 i.e., average winding temperature rise as given in Column 2 of Table 8.2 plus 300C. An increase of 7% on total for thermal class H is allowed.

7.2.1.2 Measurement and Reporting of Transformer Losses

Current transformer (CT) is used to measure current and Potential transformer (PT) is used to measure voltage. These instrument transformers as they are called are used primarily for measuring losses.

All measurement of losses shall be carried out by using calibrated digital meters of class 0.5 or better accuracy and certified by the

manufacturer. All transformers of capacity of 500 kVA and above would be equipped with additional metering class current transformers (CTs) and potential transformers (PTs) additional to requirements of Utilities so that periodic loss monitoring study may be carried out.

7.2.1.3 Voltage Drop

Voltage drop in the electrical system is the direct indicator of the system resistance. It represents the energy loss in the system which is dissipated

in the form of heat. As the length of the wire increases its resistance increases. Therefore, higher the resistance(R), more will be the voltage drop. If the current increases, there will be further losses.

The Code defines two types of conductors (Figure 7.19).

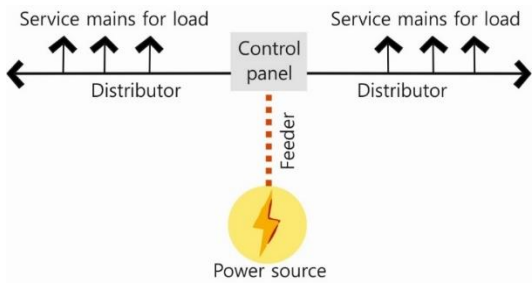

Figure 7.19 Feeder and distributors

Feeders

Feeder conductors run between the service entrance equipment (where the power enters the building) and the branch circuit distribution equipment (e.g., circuit breaker). Feeder circuits use thicker cables that travel from the main entrance panel to smaller distribution panels called subpanels, or load centers.

Branch circuit conductors run from the final circuit breaker to the load. In some small buildings, all wiring will be branches running from the main electrical service. Distributor will have multiple tapping for supplying the power to multiple loads.

Voltage drop is dependent on the following:

- Circuit type (single-phase or three phase)
- Number and size of conductors per phase
- Conduit types (magnetic or nonmagnetic)
- Power factor of the load
- Circuit length
- Load current

As per the code,

Voltage drop for feeders shall not exceed 2% at design load. Voltage drop for branch circuit shall not exceed 3% at design load.

Issue with voltage drop

In most electrical circuits the current increases as voltage at the load drops because the load requires a certain amount of power. When the current increases, there is an increase in the power loss within the conductor that varies as the square of the current ($P = I^2R$). Therefore, the voltage drop is an energy efficiency issue. Hence the Code requires that the voltage drop is controlled.

Further, the voltage drop in the conductors, if excessive, may result in equipment operation problems or equipment failure.

7.2.2 Energy Efficient Motors

Motors convert electrical energy into mechanical energy. In a commercial building, motors find diverse applications such as fans, blowers, condensers, cooling towers and many others.



Figure 7.20 Electric motor

Electric motors may be classified by the source of electric power, by their internal construction, and by their application. Motors can use either AC or DC supply. The AC motors can further be classified as shown in Figure 7.21 Motor classification.

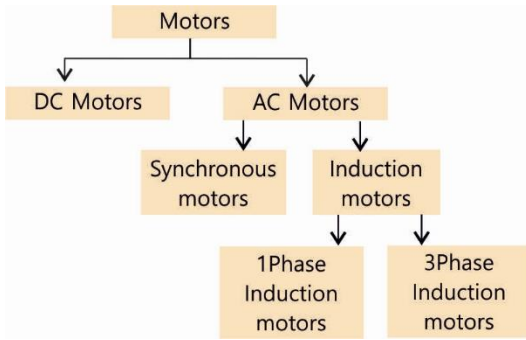

Figure 7.21 Motor classification

Motors have the following components: stator, rotor, bearings and frame. Additionally a DC motor has commutator and brushes. AC motors do not use brushes and hence have a longer life with less maintenance. Induction motors are cheaper, more rugged and easier to maintain compared to other alternatives. They are also known as asynchronous motors.

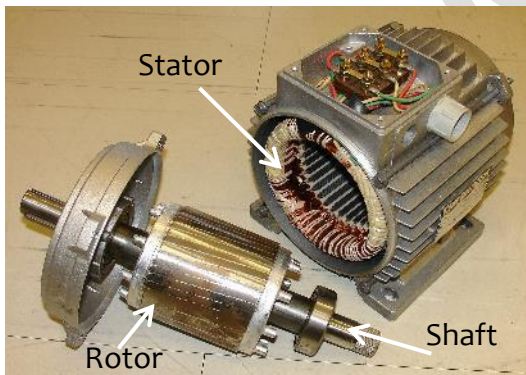

Figure 7.22 Parts of an induction motor

Induction motors

AC Induction motors are the most commonly used prime mover for various equipment in buildings.

In these motors, the induced magnetic field of the stator winding induces a current in the rotor. This rotor current produces a second magnetic field, which tries to oppose the stator magnetic field, and this causes the rotor to rotate.

Although induction motors are normally considered fixed speed machines, one potential disadvantage is that their operating speed will change with both load and voltage. In fact, it is difficult to find two induction motors that will operate at exactly the same speed, even when operated at identical voltage and frequency, and driving identical loads.

Induction motors can be constructed so that different pole pairs can be connected and disconnected as desired at the terminal box, producing a variety of speeds. Such squirrel-cage induction motors are multispeed (usually two speed), but are not variable-speed if operating from a supply at fixed frequency. In another variation, part-winding start induction motors energize part of the winding when starting and the rest later, in one or more steps, so as to reduce starting torque or current

Induction motor can also be classified into the following types based on the type of rotor:

- a) Squirrel cage motor
- b) Slip ring or wound rotor motor.

The 3-phase squirrel cage induction motor is the workhorse of most applications; it is rugged and reliable, and is by far the most common motor type used. These motors drive pumps, blowers and fans, compressors, conveyers and production lines. The 3-phase induction motor has three windings each connected to a separate phase of the power supply.

Energy efficiency of motors

Motor Efficiency is the ratio of the useful mechanical power output to the total electric power input to the motor. Like all electromechanical equipment, motors consume some “extra” energy in order to make the conversion. Efficiency reflects how much total energy a motor uses in relation to the rated power delivered to the shaft.

A motor's nameplate rating is based on output horsepower, which is fixed for continuous operation at full load. The amount of input power needed to produce rated horsepower will vary from motor to motor, with more efficient motors requiring less input wattage than less-efficient models to produce the same output. Electrical energy input is measured in watts, while output is given in horsepower. Output power for motors may also be stated in watts or kilowatts.

1 horsepower = 746 watts

The International Electrotechnical Commission (IEC) has developed the International Efficiency (IE) classes for motors. This is an international standard that stipulates the energy efficiency of low voltage AC motors. IS (Indian Standard) uses same standards to classify the motor efficiency. The IE classes are shown in Table 7 A.

Table 7 A Motor efficiency class

Class type	Class number
Standard efficiency	IE1
High efficiency	IE2
Premium efficiency	IE3
Super premium efficiency	IE4

Higher the class number, the higher the motor efficiency. As per the Code,

Motors shall comply with the following:

- (a) Three phase induction motors shall conform to Indian Standard (IS) 12615 and shall fulfil the following efficiency requirements:
 - I. ECBC Buildings shall have motors of IE 2 (high efficiency) class or a higher class
 - II. ECBC+ Buildings shall have IE 3 (premium efficiency) class motors or higher class

- III. SuperECBC Buildings shall have IE 4 (super premium efficiency) class motors
- (b) All permanently wired polyphase motors of 0.375 kW or more serving the building and expected to operate more than 1,500 hours per year and all permanently wired polyphase motors of 50kW or more serving the building and expected to operate more than 500 hour per year, shall have a minimum acceptable nominal full load motor efficiency not less than levels specified in the latest version of IS 12615. (Refer to

- (c) Table 7 B through Table 7 E)
- (d) Motors of horsepower differing from those listed in the table shall have efficiency greater than that of the next listed kW motor.

DRAFT

Table 7 B Values of Performance Characteristic of Two Pole Energy-Efficient Induction Motors

Rated Output	Frame Designation	Full Load Speed Min	Full Load Current Max	Breakaway Torque in Terms of Full Load Torque Min	Breakaway Current in Terms of Full Current, Equal or Below		Nominal Efficiency	
					For eff 2	For eff 1	For eff 2	For eff 1
kW		Rev/min	Amp	Percent	Percent	Percent	Percent	Percent
(1)	(2)	(3)	(4)	(5)	(6)	(7)	(8)	(9)
0.37	71	2790	1.2	170	600	650	66	70.2
0.55	71	2760	1.6	170	600	650	70	74
0.75	80	2780	2	170	600	650	73	77
1.1	80	2790	2.8	170	600	650	76.2	82.8
1.5	90S	2800	3.7	170	600	650	78.5	84.1
2.2	90L	2810	5	170	650	700	81	85.6
3.7	100L	2820	8	160	650	700	84	87.5
5.5	132S	2830	11	160	650	700	85.7	88.6
7.5	132S	2840	15	160	650	700	87	89.5
9.3	160M	2840	18.5	160	650	700	87.7	90
11	160M	2860	21.5	160	650	700	88.4	90.5
15	160M	2870	29	160	650	700	89.4	91.3
18.5	160L	2880	35	160	650	700	90	91.8
22	180M	2890	41.5	160	650	700	90.5	92.2
30	200L	2900	54	160	650	700	91.4	92.9
37	200L	2900	67	160	650	700	92	93.3
45	225M	2955	80	160	650	700	92.5	93.7
55	250M	2960	95	160	650	700	93	94
75	280S	2970	130	160	650	700	93.6	94.6
90	280M	2970	150	160	650	700	93.9	95
110	315S	2980	185	160	650	700	94	95
125	315M	2980	209	160	650	700	94.5	95.3
132.01)	315M	2980	220	160	650	700	94.5	95.3
160.01)	315L	2980	265	160	650	700	94.8	95.5

Note: Output to frame size relation is maintained in accordance with IS 1231 for all motors, except those marked as 1), wherein the frame size indicated is “preferred frame size.”

Source: IS 12615: 2004, Energy-Efficient Induction Motors --- Three-Phase Squirrel Cage (First Revision)

Table 7 C Values of Performance Characteristic of 4 Pole Energy-Efficient Induction Motors.

Rated Output	Frame Designation	Full Load Speed Min	Full Load Current Max	Breakaway Torque in Terms of Full Load Torque Min	Breakaway Current in Terms of Full Current, Equal or Below		Nominal Efficiency	
					For eff 2	For eff 1	For eff 2	For eff 1
kW		Rev/min	Amp	Percent	Percent	Percent	Percent	Percent
(1)	(2)	(3)	(4)	(5)	(6)	(7)	(8)	(9)
0.37	71	2790	1.2	170	600	650	66	70.2
0.55	71	2760	1.6	170	600	650	70	74
0.37	71	1330	1.4	170	550	600	66	73
0.55	80	1340	1.7	170	550	600	70	78
0.75	80	1360	2.2	170	550	600	73	82.5
1.1	90S	1370	2.9	170	550	600	76.2	83.8
1.5	90L	1380	3.8	170	550	600	78.5	85
2.2	100L	1390	5.1	170	600	700	81	86.4
3.7	112M	1410	8.1	160	600	700	84	88.3
5.5	132S	1420	11.4	160	600	700	85.7	89.2
7.5	132M	1430	15.4	160	600	700	87	90.1
9.3	160M	1430	18.5	160	600	700	87.7	90.5
11	160M	1440	22	160	600	700	88.4	91
15	160L	1440	30	160	600	700	89.4	91.8
18.5	180M	1440	36	160	600	700	90	92.2
22	180L	1440	43	160	600	700	90.5	92.6
30	200L	1450	56	160	600	700	91.4	93.2
37	225S	1450	69	160	650	700	92	93.6
45	225M	1460	84	160	600	700	92.5	93.9
55	250M	1460	99	160	600	700	93	94.2
75	280S	1470	134	160	600	700	93.6	94.7
90	280M	1470	164	160	600	700	93.9	95
110	315S	1480	204	160	600	700	94.4	95.2
125	315M	1480	234	160	600	700	94.7	95.5
132.01)	315M	1480	247	160	600	700	94.7	95.5
160.01)	315L	1480	288.0.	160	600	700	95	95.8

Note: Output to frame size relation is maintained in accordance with IS 1231 for all motors, except those marked as 1), wherein the frame size indicated is "preferred frame size."

Source: IS 12615: 2004, Energy-Efficient Induction Motors --- Three-Phase Squirrel Cage (First Revision)

Table 7 D Values of Performance Characteristic of 6 Pole Energy-Efficient Induction Motors.

Rated Output	Frame Designation	Full Load Speed Min	Full Load Current Max	Breakaway Torque in Terms of Full Load Torque Min	Breakaway Current in Terms of Full Current, Equal or Below		Nominal Efficiency	
					For eff 2	For eff 1	For eff 2	For eff 1
kW		Rev/min	Amp	Percent	Percent	Percent	Percent	Percent
(1)	(2)	(3)	(4)	(5)	(6)	(7)	(8)	(9)
0.37	80	870	1.4	160	550	600	65	69.4
0.55	80	870	1.9	160	550	600	68	72
0.75	90S	890	2.3	160	550	600	71	74.6
1.1	90L	900	3.2	160	550	600	74	77.3
1.5	100L	900	4	160	550	600	76	79.6
2.2	112M	910	5.5	150	600	700	79	82.2
3.7	132S	920	8.8	150	600	700	82.5	85.1
5.5	132M	920	12.7	150	600	700	84.5	86.8
7.5	160M	930	16.7	150	600	700	86	88.1
9.3	160L	930	20.5	140	600	700	87	89.3
11	160L	935	23.0	140	600	700	87.5	89.7
15	180L	940	30.5	140	600	700	88.5	90.5
18.5	200L	940	37.5	140	600	700	89.5	91.3
22	200L	945	44	140	600	700	90	91.8
30	225M	945	59	140	600	700	91	92.6
37	250M	950	72	140	600	700	91.5	93
45	280S	960	87	140	600	700	92	93.4
55	280M	960	107	140	600	700	92.5	93.8
75	315S	970	145	140	600	700	93	94.2
90	315M	970	175	140	600	700	93.3	94.5
110.01)	315M	970	214	140	600	700	93.5	94.6
132.01)	315L	980	257	140	600	700	93.8	94.9

Note: Output to frame size relation is maintained in accordance with IS 1231 for all motors, except those marked as 1), wherein the frame size indicated is "preferred frame size."

Source: IS 12615: 2004, Energy-Efficient Induction Motors --- Three-Phase Squirrel Cage (First Revision)

Table 7 E Values of Performance Characteristic of 8 Pole Energy-Efficient Induction Motors.

Rated Output	Frame Designation	Full Load Speed Min	Full Load Current Max	Breakaway Torque in Terms of Full Load Torque Min	Breakaway Current in Terms of Full Current, Equal or Below		Nominal Efficiency	
					For eff 2	For eff 1	For eff 2	For eff 1
kW		Rev/min	Amp	Percent	Percent	Percent	Percent	Percent
(1)	(2)	(3)	(4)	(5)	(6)	(7)	(8)	(9)
0.37	90S	640	1.5	150	550	600	62	66.8
0.55	90L	640	2.1	150	550	600	67	71.1
0.75	100L	650	2.7	150	550	600	70	73.8
1.1	100L	660	3.5	150	550	600	72	76.2
1.5	112M	670	4.5	150	550	600	74	77.9
2.2	132S	680	6.1	140	600	700	77	80.5
3.7	160M	690	9.8	140	600	700	80	83
5.5	160M	690	14.2	140	600	700	82.5	85.1
7.5	160L	695	19	140	600	700	84	86.4
9.3	180L	700	23	140	600	700	85	87.3
11	180L	700	26	140	600	700	86	88.1
15	200L	705	35	130	600	600	87	89
18.5	225S	705	45	130	600	700	88	89.8
22	225M	710	52	130	600	700	88.5	90.2
30	250M	710	70	130	600	700	90	91.5
37	280S	710	86	130	600	700	90.5	90.5
45	280M	720	99	130	600	700	91	92.4
55	315S	720	118	130	600	700	91.5	92.8
75	315M	730	153	130	600	700	92.3	93.5
90.01)	315L	730	182	130	600	700	92.8	93.9
110.01)	315L	730	218	130	600	700	93.3	94.3

Note: Output to frame size relation is maintained in accordance with IS 1231 for all motors, except those marked as 1), wherein the frame size indicated is "preferred frame size."

Source: IS 12615: 2004, Energy-Efficient Induction Motors --- Three-Phase Squirrel Cage (First Revision)

Consequences of Motor Over Sizing

When motors are oversized and operate for extended periods at significantly less than full load, there are three significant operational penalties – reduced efficiency, reduced slip (important if the load is a cube-law type), and reduced power factor.

Depending on the motor, efficiency will typically peak at somewhere between 75% load and full load. The larger the motor and the higher its peak efficiency, the more likely it will have a relatively flat efficiency curve between 50% load and full load, with a hump at 75% load some 0.3 to 1% points higher than at full load. Efficiency drops

precipitously below 50% load, with the average 100-hp energy efficient motor losing over two points between 50 and 25% load and the average 100-hp standard efficiency induction motor dropping some 5.5 points over the same range. Smaller motors lose even more, particularly at lower efficiencies.

A general rule-of-thumb is that a one percentage point increase in efficiency is equivalent to about a one-third-point increase in slip – a decrease in slip can therefore quickly negate even a significant energy efficiency improvement.

As per the Code,

- (e) Motor horsepower ratings shall not exceed 20% of the calculated maximum load being served.
- (f) Motor nameplates shall list the nominal full-load motor efficiencies and the full-load power factor.

Motor rewinding

Motor failures are frequently caused by bearing failures and are often accompanied by the breakdown of the coils of insulated wire inside the motor (the stator windings) and other problems. When a motor fails, the owner is faced with deciding whether to rebuild it or replace it. Rebuilding, commonly called rewinding, usually entails a lower initial cost compared to a replacement motor, especially for larger motors. Rewinding can preserve and, in rare cases, slightly improve motor efficiency if skilfully done. However, the rewinding process provides many avenues by which the motor efficiency can be degraded, greatly increasing operating cost and energy consumption.

To ensure the highest quality in repaired motors, the consistent use of test equipment and documentation procedures must be an integral part of the repair process, so that the efficiency of the motor and the quality of its components can be verified before the motor is put back into service.

A critical task in most motor rebuilds is to remove the old windings without altering the adjacent laminated steel cores, and then to wrap new insulated wire around the old cores.

The old windings are commonly embedded in thick coats of varnish (used to glue the windings inside the core slots) which prevent their easy removal. Heat, chemicals, or mechanical force are commonly used to loosen and pull out old windings; excessive use of any of these can cause damage to the cores. Improper machining, replacement bearings, wire diameter, and

winding technique can all compound, resulting in a rebuilt motor with poor performance and lower efficiency.

Although it is technically possible to rebuild a motor to its original specifications, survey results of actual rewind practices show that this is seldom the case. On the average, rewind motors are less efficient than they were before rewinding. The magnitude of this problem can vary widely from one rewind shop to another, and can only be properly identified when efficiency measurements are taken before and after rewinding.

As per the Code,

- (g) Motor users should insist on proper rewinding practices for any rewind motors. If the proper rewinding practices cannot be assured, the damaged motor should be replaced with a new, efficient one rather than suffer the significant efficiency penalty associated with typical rewind practices. Rewinding practices from BEE guideline for energy efficient motors shall be followed.
- (h) Certificates shall be obtained and kept on record indicating the motor efficiency. Whenever a motor is rewound, appropriate measures shall be taken so that the core characteristics of the motor is not lost due to thermal and mechanical stress during removal of damaged parts. After rewinding, a new efficiency test shall be performed and a similar record shall be maintained.

7.2.3 Diesel Generator (DG)sets:

DG sets are used for power backup in buildings. Additionally, it could also be used to generate power for peak load application. Using diesel as the fuel, the generator converts mechanical energy into electrical energy. DG sets can be located inside the building or outside.

The DG set as a system consists of the diesel engine, AC alternator, control system and switchgear, foundation and corresponding civil works, exhaust facilities and fuel storage. Some of the disadvantages of the DG set are noise, vibration and pollution due to the exhaust.

Selection criteria for a DG set³

The two most important factors are: power and speed of the engine.

The power requirement is determined by the maximum load. The engine power rating should be 10 – 20 % more than the power demand by the end use. This prevents overloading the machine by absorbing extra load during starting of motors or switching of some types of lighting systems or when wear and tear on the equipment pushes up its power consumption.

Speed is measured at the output shaft and given in revolutions per minute (RPM). There will be an optimum speed at which fuel efficiency will be greatest. Engines should be run as closely as possible to their rated speed to avoid poor efficiency and to prevent build up of engine deposits due to incomplete combustion – which will lead to higher maintenance and running costs. Speed requirements again depend on the load.

Energy efficiency in a DG set

The Star Labeling program of the Bureau of energy efficiency (BEE) determines the energy performance for various appliances and equipment. The Star Label provides consumer the information about energy saving and thereby cost saving potential of the relevant marketed product. With the display of the information on the product, consumer can make the right choice.

³ Source: BEE India
(<https://beeindia.gov.in/sites/default/files/3Ch9.pdf>)

Star rating or star level means the grade of energy efficiency based on specific fuel consumption (SFC) in g/kWh (electrical unit), displayed on the label of the generating set. More stars are equivalent to better energy performance. The available stars are between a minimum of one and a maximum of five shown in Table 7 F.

Table 7 F BEE star rating for DG systems (Source-BEE star rating for DG sets)

Star level	Specific Fuel Consumption (SFC) in g/kWh
1	>302 & ≤336
2	>272 & ≤302
3	>245 & ≤272
4	>220 & ≤245
5	≤220

As per the Code,

BEE star rated DG sets shall be used in all compliant buildings. DG sets in buildings greater than 20,000 m² BUA shall have:

- (a) minimum 3 stars rating in ECBC Buildings
- (b) minimum 4 stars rating in ECBC+ Buildings
- (c) minimum 5 stars rating in SuperECBC Buildings

7.2.4 Check-Metering and monitoring

A significant barrier to achieving energy efficiency during the operation of a building is inadequate metering systems and monitoring plans. Building operators cannot be expected to manage energy if they cannot measure energy use. To improve a building's energy performance over its operating life, and optimize the energy-efficient requirements, the Code requires that the building's performance be measured.

Metering is about having information that allows energy managers to analyze and track changes in energy demand and, therefore, to manage their energy use more effectively. Energy metering is not a new concept and has been used by large energy-intensive building for many years to monitor energy consumption.

Meters are commonly used in buildings, but submeters might not be. Submeters help monitor energy end uses such as air conditioning, lighting, plug loads and renewables. Such data helps in optimizing energy use during operations and troubleshoot issues effectively when necessary.

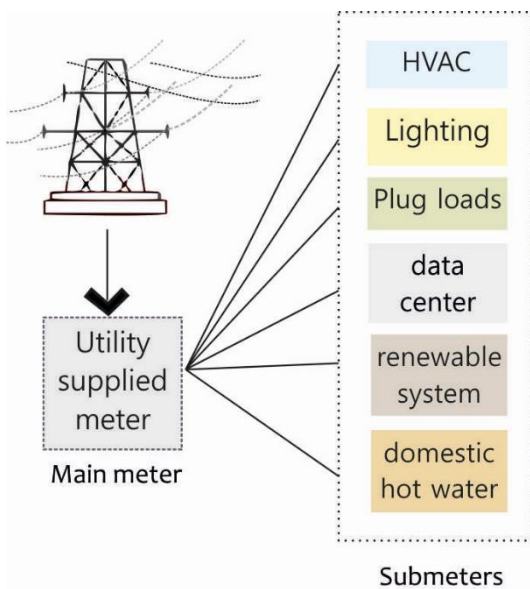

Figure 7.23 Submetering

For example, failure in a cooling equipment might spike the energy use for cooling, but would not impact lighting energy use. When the energy data is combined, it is difficult to identify the reason for the increase in energy use.

Submetering is one of the best practices in the field of energy management. Some of the benefits of submetering are listed below

- Provide actual data of energy consumption by an end-use (no estimates)
- Opportunity for the energy manager to make informed decision for performance improvement
- Check the wastage of energy
- Better maintenance of equipment

As per the Code, the main meter should be able to record energy, demand and power factor. The Code requires that submeters be provided for certain specialized applications such as façade lighting for shopping complex, commercial kitchens in hospitality building and data center in large commercial buildings. The requirement for submetering has been made mandatory in the Code with the intent of providing opportunity for efficient monitoring during operations ensuring energy efficiency over lifetime of the building.

It is mandatory to provide sub-meters in

- (a) Services exceeding 1000 kVA shall have permanently installed electrical metering to record demand (kVA), energy (kWh), and total power factor. The metering shall also display current (in each phase and the neutral), voltage (between phases and between each phase and neutral), and total harmonic distortion (THD) as a percentage of total current.
- (b) Services not exceeding 1000 kVA but over 65 kVA shall have permanently installed electric metering to record demand (kW), energy (kWh), and total power factor (or kVARh).
- (c) Services not exceeding 65 kVA shall have permanently installed electrical metering to record energy (kWh).
- (d) In case of tenant based building, metering should be provided at a location from where each tenant could attach the services.

Table 7-3 Sub Metering Requirements

	120 kVA to 250 kVA	Greater than 250 kVA
<i>Minimum requirement for metering of electrical load</i>		
Energy kWh	Required	Required
Demand kVA	Required	Required
Total power factor	Required	Required
<i>Minimum requirement for separation of electrical load</i>		
HVAC system and components	Required	Required
Interior and Exterior Lighting *	Not required	Required
Domestic hot water	Not required	Required
Plug loads	Not required	Required
Renewable power source	Required	Required
<i>Mandatory requirement for building type over the requirement stated above</i>		
Shopping Complex	Façade lighting	Elevator, escalators, moving walks
Business	Data centers	
Hospitality	Commercial kitchens	
* Hotel guestrooms and hospital in patient areas are exempted from the lighting sub-metering requirements.		

7.2.5 Power Factor Correction

Power Factor is the ratio between the useful (true) power (kW) to the total (apparent) power (kVA) consumed by electrical equipment or a complete electrical installation. It is a measure of how efficiently electrical power is converted into useful work output. The definition and calculation of power factor has been discussed in detail in 7.1. The ideal power factor is unity, or one. Anything less than one means that extra power is required to achieve the actual task at hand. Inductive loads require reactive power to create magnetizing fields to perform the desired function. This reactive power causes the power factor to reduce. Increasing power factor is required to achieve energy efficiency.

As per the Code,

All 3 phases shall maintain their power factor at the point of connection as follows:

- (a) 0.97 for ECBC Building
- (b) 0.98 for ECBC+ building
- (c) 0.99 for SuperECBC building

Power factor correction methods

Power factor correction is the process of adjusting the characteristics of electric loads in order to improve power factor so that it is closer to 1 (unity).

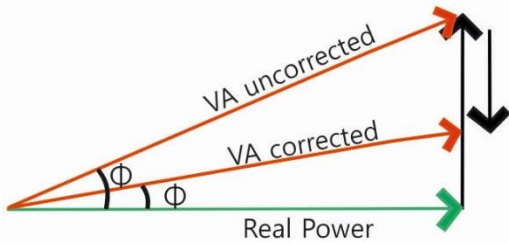

Figure 7.24 Power factor correction

It can be done by the following methods.

Capacitors

Capacitors are added to the electrical network which compensate for the reactive power demand of the inductive load and thus reduce the burden on the supply.

Capacitors store power like batteries. The fundamental difference between the two is that a capacitor can discharge energy rapidly in a few seconds while a battery might take some time few minutes. Thus, it provides instant supply of energy in no time.

The reactive power is provided by the capacitor or bank of capacitors installed parallel to the load. Capacitors contained in most power factor correction equipment draw current that leads the voltage, thus producing a leading power factor. Typically the corrected power factor will be 0.92 to 0.95.

Synchronous condenser

They are 3 phase synchronous motors with no load attached to its shaft. The synchronous motor has the characteristics of operating under any power factor leading, lagging or unity depending upon the excitation. For inductive

loads, the synchronous condenser is connected towards load side and is overexcited. This makes it behave like a capacitor. It draws the lagging current from the supply or supplies the reactive power

Benefits of improved power factor

- Reduction of power consumption due to improved energy efficiency.
- Reduction of electricity bills
- Extra kVA available from the existing supply
- Reduction of I²R losses in transformers and distribution equipment
- Reduction of voltage drop in long cables.
- Extended equipment life – Reduced electrical burden on cables and electrical components.

7.2.6 Power Distribution Systems

Power distribution systems is the network of wires/cables that distribute power to all the end-uses in a building from the point of supply. For a given load, energy losses depend on the size and material of the wires, length of wires and the overall circuit design.

Usually, the distribution voltage of 230V is fixed in buildings. Thus, sizing of the wires/cable depend on the load and current. Building loads are determined during the design stage. It is important to get accurate data as far as possible to design the size of the cable and avoid over-sizing.

Based on the types of the load distribution lines must be segregated. For example, distribution line for HVAC must not be used for supplying the lighting loads. This disaggregation of cables will reduce the load in each distribution line minimize the losses.

Distribution losses due to heat generated by friction in the cables. The longer the wires, more is the heat loss. Thicker the wire, more is the heat loss. Further material of the cable itself offers

some friction depending on how good a conductor it is. An engineer or contractor can demonstrate real savings as well as the advantages of lower heat generated and increased flexibility of the installation with a properly sized distribution system. In addition, when less heat is generated, the result is reduced energy requirements for fans and air conditioning systems.

The power cabling shall be sized so that the distribution losses do not exceed

- (a) 3% of the total power usage in ECBC Buildings
- (b) 2% of the total power usage in ECBC+ Buildings
- (c) 1% of total power usage in SuperECBC Buildings

Record of design calculation for the losses shall be maintained. Load calculation shall be calculated up to the panel level.

7.2.7 Uninterruptible Power Supply (UPS)

UPS provides backup power when utility power fails, either long enough for critical equipment to shut down properly so that no data is lost, or long enough to keep required loads operational until a generator comes online. Along with backup power, it conditions incoming power so that quality power reaches to the load. It is commonly used to dedicatedly serve critical loads such as computers, servers, routers and other IT loads.

These losses in the system occur due to internal circuitry of the UPS system. Generally, UPS has efficiency equal or greater than 90%. For some UPS, it could reach up to 97%. As per the Code,

In all buildings, UPS shall meet or exceed the energy efficiency requirements listed in Table 7-4. Any Standards and Labeling program by BEE

shall take precedence over requirements listed in this section.

Table 7-4 Energy Efficiency Requirements for UPS for ECBC, ECBC+, SuperECBC building

UPS Size	Energy Efficiency Requirements at 100% Load
kVA < 20	90.2%
20 ≤ kVA ≤ 100	91.9%
kVA > 100	93.8%

7.2.8 Renewable Energy Systems

Using fossil fuels like coal and oil for energy production has two primary issues - it is a finite natural resource and burning them causes greenhouse gas emissions that is responsible for climate change. Energy produced using natural sources like solar, wind, hydro, bioenergy and geothermal etc., are called as renewable energy systems. These sources are renewed in the natural process and since there is no burning involved, they are a clean source of energy. Moreover, reliable energy supply is the major factor for the socio-economic development of society. Further, using renewable energy promoted sustainable development.

The long term vision of the Code is to enable the building industry to achieve net-zero energy or near-zero energy goals by progressively increasing the energy efficiency over time. An integral aspect of net-zero buildings is on-site energy generation using renewable energy technologies system solar photovoltaic, solar thermal, wind, etc.

Different renewable energy systems suitable for installation in buildings are discussed below.

Solar energy systems

Solar energy is by far the most commonly used renewable source of energy. There are two primary methods in which solar energy can be utilised - to produce heat (solar thermal) and to

produce electricity (solar photovoltaic). Selection of the method depends on the application.

Solar photovoltaic (PV) systems

Solar PV is a semiconductor-based technology. Photovoltaic cells are nothing, but the P-N junctions made from semiconductor material like silicon, germanium etc. that convert sunlight into electrical energy.

An individual PV cell is small, typically producing about 0.5 volts. To get the higher output PV cells are connected in series to form larger units known as modules or panels. Modules can be used individually, or several can be connected to form arrays. One or more arrays are then connected to an inverter to feed the load as part of a complete PV system. Because of this modular structure, PV systems can be built to meet almost any electric power need, small or large.

Technological advancements have improved the efficiency of the solar panels over the years and it is becoming more and more economically feasible to implement these systems.

There are two modes to using energy generated by solar PV system.

1) Off-grid systems

In this method, the energy produced by the solar PV system installed on-site is used stored and used on site. This system is independent of the utility grid. For this system, it is necessary to have the complete infrastructure of the PV system in place including PV generator, battery for storage, charge controller and inverters. The building can still be connected to the grid to ensure continuous supply of power in case of non-availability of solar energy.

2) Grid connected system

This method is gaining popularity today where the local utility provides an option of net-

metering. Here, the on-site PV system is connected to the grid. the electricity produced by the solar system is supplied directly to the utility while the building continues to be powered through the grid.

A meter measures the units of energy produced and consumed and the net amount is calculated and charged to the consumer. There are many advantages of this model of operation. Firstly, the utility benefits from more energy production which eases the load on the power plant to meet the rising energy demand. Secondly, the consumer need not install the supporting infrastructure such as batteries, inverters and electrical wiring for the PV system since the energy is not used directly in the building. This saves space, easy to maintain and is economical as well. Thirdly, during seasonal changes such as summer when the production is likely to be higher than demand, the excess energy if sent to the grid to be utilised. This excess can be balanced against lower production during winter or monsoon season. Hence net metering is advantageous.

Solar Thermal system

Solar thermal systems are commonly used for water heating. This is discussed in detail in §5.2.7.

Micro Wind Turbines

Micro wind turbines are emerging as a promising renewable energy option for rooftop installations. Micro wind turbines of 5kW capacity can easily be installed in about two square meters area. These systems could be more appropriate for buildings that are very tall or have large open spaces which allows good wind speeds. Micro wind turbines can be combined with rooftop solar PV power plants.

The intent of the §7.2.8 requirements is to encourage thinking and planning for renewable systems during the design and construction stage

itself, so that the integration of the system is easier in the future. The mandatory requirements in §7.2.8 covers both physical space and technical requirements.

The Code mandates the “provision of space” for renewable system which is called as the Renewable Energy Generating Zone (REGZ). The REGZ is a dedicated area on the building rooftop where the renewable system can be installed in the future.

As per the Code,

7.2.8.1 Renewable Energy Generating Zone (REGZ)

- (a) A dedicated REGZ equivalent to at least 25 % of roof area or area required for generation of energy equivalent to 1% of total peak demand or connected load of the building,

whichever is less, shall be provided in all buildings.

Connected load will include all systems that use electricity such as lighting, comfort systems and receptacles.

- (b) The REGZ shall be free of any obstructions within its boundaries and from shadows cast by objects adjacent to the zone.

Obstruction free solar access is important for the solar-based renewable systems to work effectively. Any future additions should be planned to provide solar access.

- (c) ECBC+ and SuperECBC building shall fulfil the additional requirements listed in Table 7-5 and Table 7-6 respectively.

Exception to §7.2.8.1: Projects with solar hot water and/ or solar power generation systems.

Table 7-5 Minimum Solar Zone Area/Renewable Energy Generating Zone Requirement for ECBC+ Building

<i>Building Type</i>	<i>Minimum Electricity to be Generated in REGZ</i>
<i>All building types except below</i>	<i>Minimum 2% of total electrical load</i>
<i>Star Hotel > 20,000 m²</i>	<i>Minimum 3% of total electrical load</i>
<i>Resort > 12,500 m²</i>	
<i>University > 20,000 m²</i>	
<i>Business >20,000 m²</i>	

Table 7-6 Minimum Solar Zone Area/Renewable Energy Generating Zone Requirement for SuperECBC Building

<i>Building Type</i>	<i>Minimum Electricity to be Generated in REGZ</i>
<i>All Building types except below</i>	<i>Minimum 4% of total electrical load</i>
<i>Star Hotel > 20,000 m²</i>	<i>Minimum 6% of total electrical load</i>
<i>Resort > 12,500 m²</i>	
<i>University > 20,000 m²</i>	
<i>Business >20,000 m²</i>	

7.2.8.2 Main Electrical Panel

Integration of solar electric systems in the future requires planning at the main electrical panel as well. As per the Code,

Minimum rating shall be displayed on the main electrical service panel. Space shall be reserved for the installation of a double pole circuit breaker for a future solar electric installation.

7.2.8.3 Demarcation on Documents

The Code requires that the provision for renewable is clearly shown in the design and construction documents in terms of space, structure as well as supporting services like electrical and plumbing.

The following shall be indicated in design and construction documents:

- (a) Location for inverters and metering equipment,
- (b) Pathway for routing of conduit from the REGZ to the point of interconnection with the electrical service,
- (c) Routing of plumbing from the REGZ to the water-heating system and,
- (d) Structural design loads for roof dead and live load.

DRAFT

DEFINITIONS, ABBREVIATIONS, & ACRONYMS

8. DEFINITIONS, ABBREVIATIONS, AND ACRONYMS

8.1 General

Certain terms, abbreviations, and acronyms are defined in this section for the purposes of this code. These definitions are applicable to all sections of this code. Terms that are not defined shall have their ordinarily accepted meanings within the context in which they are used.

8.2 Definitions

A

Above grade area (AGA): AGA is the cumulative floor area of all the floor levels of a building that are above the ground level. Ground level shall be as defined in building site plan. A floor level is above grade if one-third of the total external surface area of only the said floor level is above the ground level.

Accredited independent laboratory: testing laboratory not affiliated with producer or consumer of goods or products tested at the laboratory and accredited by national or international organizations for technical competence

Addition: an extension or increase in floor area or height of a building outside of the existing building envelope.

Air conditioning and condensing units serving computer rooms: air conditioning equipment that provides cooling by maintaining space temperature and humidity within a narrow range. Major application is in data centers where dissipating heat generated by equipment takes precedence over comfort cooling for occupants.

Alteration: any change, rearrangement, replacement, or addition to a building or its systems and equipment; any modification in construction or building equipment.

Area weighted average (AWA) method: AWA method is based on the concept of weighted arithmetic mean where instead of each data point contributing equally to the final mean; each data point contributes more “weight” than others based on the size of the area the said data point is applicable to. To calculate the area weighted average mean, a summation of each data point multiplied with its respective area is divided with the total area.

$$AWA = \sum \frac{(\text{Data point } X \text{ area})}{\text{Total area}}$$

Astronomical time switch: an automatic time switch that makes an adjustment for the length of the day as it varies over the year.

Authority having jurisdiction: the agency or agent responsible for enforcing this Standard.

B

Balancing, air system: adjusting airflow rates through air distribution system devices, such as fans and diffusers, by manually adjusting the position of dampers, splitters vanes, extractors, etc., or by using automatic control devices, such as constant air volume or variable air volume boxes.

Balancing, hydronic system: adjusting water flow rates through hydronic distribution system devices, such as pumps and coils, by manually adjusting the position valves, or by using automatic control devices, such as automatic flow control valves.

Ballast: a device used in conjunction with an electric-discharge lamp to cause the lamp to start and operate under proper circuit conditions of voltage, current, waveform, electrode heat, etc.

Standard Design: a computer model of a hypothetical building, based on actual building design, that fulfils all the mandatory requirements and minimally complies with the prescriptive requirements of ECBC.

Boiler: a self-contained low-pressure appliance for supplying steam or hot water

Building or building complex or complex: a structure wholly or partially enclosed within exterior walls, or within exterior and party walls, and a roof, affording shelter to persons, animals, or property. Building complex means a building or group of buildings constructed in a contiguous area for business, commercial, institutional, healthcare, hospitality purposes or assembly buildings under the single ownership of individuals or group of individuals or under the name of a co-operative group society or on lease and sold as shops or office space or space for other commercial purposes, having a connected load of 100 kW or contract demand of 120 kVA and above.

Building, base: includes building structure, building envelope, common areas, circulation areas, parking, basements, services area, plant room and its supporting areas and, open project site area.

Building, core and shell: buildings where the developer or owner will only provide the base building and its services.

Building, existing: a building or portion thereof that was previously occupied or approved for occupancy by the authority having jurisdiction.

Building envelope: the exterior plus the semi-exterior portions of a building. For the purposes of determining building envelope requirements, the classifications are defined as follows:

- (a) Building envelope, exterior: the elements of a building that separate conditioned spaces from the exterior
- (b) Building envelope, semi-exterior: the elements of a building that separate conditioned space from unconditioned space or that enclose semi-heated spaces through which thermal energy may be transferred to or from the exterior, or to or

from unconditioned spaces, or to or from conditioned spaces

Building grounds lighting: lighting provided through a building's electrical service for parking lot, site, roadway, pedestrian pathway, loading dock, and security applications

Building material: any element of the building envelope through which heat flows and that heat is included in the component U-factor calculations other than air films and insulation

Built up area (BUA): sum of the covered areas of all floors of a building, other than the roof, and areas covered by external walls and parapet on these floors.

24-hour Business Building: Business building operated and occupied for more than 12 hours on each weekday. Intensity of occupancy may vary.

C

Cardinal direction: cardinal directions or cardinal points are the four main directional points of a compass: north, south, east, and west which are also known by the first letters: N,S,E, and W.

Carpet area: net area measured between external walls, from the inner faces of walls. Thickness of internal or partition walls is excluded.

Centralized control: single hardware/ software for observing and controlling operations of a group of equipment and devices with similar or different functions

Circuit breaker: a safety device that automatically stops flow of current in electrical circuits. It protects the circuit from current surge.

Class of construction: classification that determines the construction materials for the building envelope, roof, wall, floor, slab-on-grade floor, opaque door, vertical fenestration, skylight

Daylight window: fenestration 2.2 meter above floor level, with an interior light shelf at bottom of this fenestration

Coefficient of Performance (COP) – cooling: the ratio of the rate of heat removal to the rate of energy input, in consistent units, for a complete refrigerating system or some specific portion of that system under designated operating conditions

Coefficient of Performance (COP) – heating: the ratio of the rate of heat delivered to the rate of energy input, in consistent units, for a complete heat pump system, including the compressor and, if applicable, auxiliary heat, under designated operating conditions

Common area: areas within a building that are available for use by all tenants in a building (i.e. lobbies, corridors, restrooms, etc.)

Commercial building: a building or a part of building or building complex which are used or intended to be used for commercial purposes and classified as per the time of the day the building is operational and sub classified, as per the functional requirements of its design, construction, and use as per following details:

- a) Group I – 24 hours building covering Type A Hospitality, Type B Health Care and Type C Assembly and,
- b) Group II – Regular building covering Type D Business, Type E Educational and Type F Shopping Complexes.

Compliance documents: the forms specified in ECBC Rules and Regulations to record and check compliance with these rules. These include but are not limited to EPI Ratio Compliance Report, Building Envelope Compliance Form, Mechanical Systems Compliance Form and Permit Checklist, Lighting System Compliance Form and Permit Checklist and certificates from Certified Energy Auditor for existing or proposed buildings.

Connected load: the sum of the rated wattage of all equipment, appliances and devices to be installed in the building or part of building or building complexes, in terms of kilowatt (kW) that will be allocated to all applicants for electric power consumption in respect of the proposed building or building complexes on their completion.

Contract demand: the maximum demand in kilowatt (kW) or kilo Volt Ampere (kVA) (within a consumer's sanctioned load) agreed to be supplied by the electricity provider or utility in the agreement executed between the user and the utility or electricity provider.

Construction documents: drawings or documents, containing information pertaining to building construction processes and approvals, building materials and equipment specification, architectural details etc. required by the authority having jurisdiction.

Controls or control device: manually operated or automatic device or software to regulate the operation of building equipment

Cool roof: roof with top layer of material that has high solar reflectance and high thermal emittance properties. Cool roof surfaces are characterized by light colors so that heat can be rejected back to the environment.

Cumulative design EPI: energy performance index for a building having two or more different functional uses and calculated based on the area weighted average (AWA) method

D

Daylight area: the daylight illuminated floor area under horizontal fenestration (skylight) or adjacent to vertical fenestration (window), described as follows:

- (a) Horizontal Fenestration: the area under a skylight, monitor, or sawtooth configuration with an effective aperture greater than 0.001 (0.1%). The daylight area is calculated as the horizontal dimension in each direction equal to the top aperture dimension in that direction plus either the floor-to-ceiling height (H) for skylights, or 1.5 H for monitors, or H or 2H for the sawtooth configuration, or the distance to the nearest 1 meter or higher opaque partition, or one-half the distance to an adjacent skylight or vertical glazing, whichever is least, as shown in the plan and section figures below.

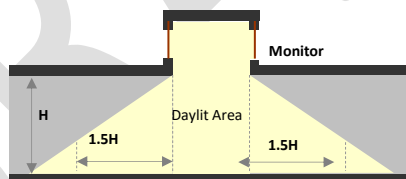
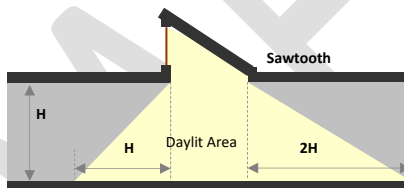
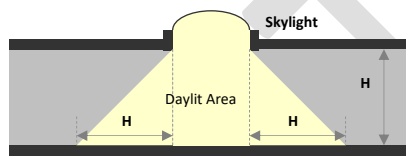
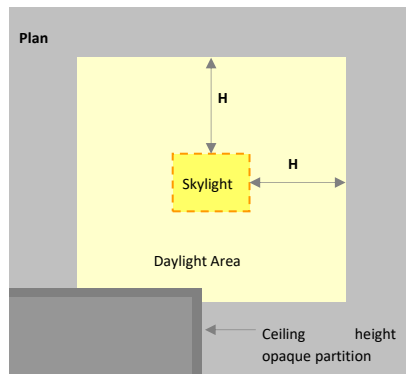

- (b) Vertical Fenestration: the floor area adjacent to side apertures (vertical fenestration in walls) with an effective aperture greater than 0.06 (6%). The daylight area extends into the space perpendicular to the side aperture a distance equal to daylight extension factor (DEF) multiplied by the head height of the side aperture or till higher opaque partition, whichever is less. In the direction parallel to the window, the daylight area extends a horizontal dimension equal to the width of the window plus either 1 meter on each side of the aperture, or the distance to an opaque partition, or one-half the distance to an adjacent skylight or window, whichever is least.

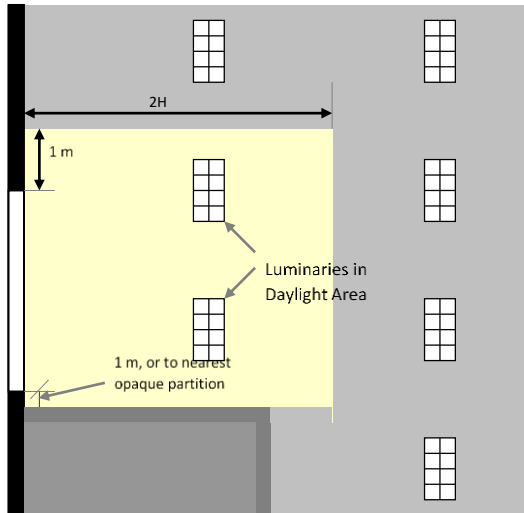

Daylight Extension Factor (DEF): factor to manually calculate the daylight area on floor plates. It is to be multiplied by the head height of windows. It is dependent on orientation and glazing VLT, shading devices adjacent to it and building location.

Daytime Business Building: Business building operated typically only during daytime on weekdays upto 12 hours each day.

Deadband: the range of values within which a sensed variable can vary without initiating a change in the controlled process.

Demand: maximum rate of electricity (kW) consumption recorded for a building or facility during a selected time frame.

Demand control ventilation (DCV): a ventilation system capability that provides automatic reduction of outdoor air intake below design rates when the actual occupancy of spaces served by the system is less than design occupancy

Design capacity: output capacity of a mechanical or electrical system or equipment at design conditions

Design conditions: specified indoor environmental conditions, such as temperature, humidity and light intensity, required to be produced and maintained by a system and under which the system must operate

Distribution system: network or system comprising controlling devices or equipment and distribution channels (cables, coils, ducts, pipes etc.) for delivery of electrical power or, cooled or heated water or air in buildings

Door: all operable opening areas, that are not more than one half glass, in the building envelope, including swinging and roll-up doors, fire doors, and access hatches. For the purposes of determining building envelope requirements, the door types are defined as follows:

- (a) Door, non-swinging: roll-up sliding, and all other doors that are not swinging doors.
- (b) Door, swinging: all operable opaque panels with hinges on one side and opaque revolving doors.

Door area: total area of the door measured using the rough opening and including the door slab and the frame.

E

Economizer, air: a duct and damper arrangement with automatic controls that allow a cooling system to supply outdoor air to reduce or eliminate the need for mechanical cooling during mild or cold weather

Economizer, water: a system by which the supply air of a cooling system is cooled indirectly with water that is itself cooled by heat or mass transfer to the environment without the use of mechanical cooling

ECBC Building: a building that complies with the mandatory requirements of §4 to §7 and also complies either with the prescriptive requirements stated under the ECBC Building categories of §4 to §7, or, with the whole building performance compliance method of §9.

ECBC+ Building: a building that complies with the mandatory requirements of §4 to §7 and also complies either with the prescriptive requirements stated under the ECBC+ Building categories of §4 to §7, or, with the whole building performance compliance method of §9. This is a voluntary level of compliance with ECBC.

Effective aperture: Visible Light Transmittance x window-to-wall Ratio. ($EA = VLT \times WWR$)

Effective aperture, horizontal fenestration: a measure of the amount of daylight that enters a space through horizontal fenestration (skylights). It is the ratio of the skylight area times the visible light transmission divided by the gross roof area above the daylight area. See also daylight area.

Effective aperture, vertical fenestration: a measure of the amount of daylight that enters a space through vertical fenestration. It is the ratio of the daylight window area times its visible light transmission plus half the vision glass area times its visible light transmission and the sum is divided by the gross wall area. Daylight window area is located 2.2 m or more above the floor and vision window area is located above 1 m but below 2.2 m. The window area, for the purposes of determining effective aperture shall not include windows located in light wells when the angle of obstruction (α) of objects obscuring the sky dome is greater than 70° , measured from the horizontal, nor shall it include window area located below a height of 1 m. See also daylight area.

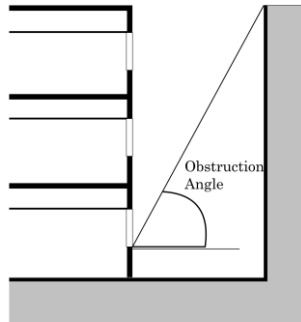

Efficacy: the lumens produced by a lamp plus ballast system divided by the total watts of input power (including the ballast), expressed in lumens per watt

Efficiency: performance at a specified rating condition

Efficiency, thermal: ratio of work output to heat input

Efficiency, combustion: efficiency with which fuel is burned during the combustion process in equipment

Emittance: the ratio of the radiant heat flux emitted by a specimen to that emitted by a blackbody at the same temperature and under the same conditions

Energy: power derived from renewable or non-renewable resources to provide heating, cooling and light to a building or operate any building equipment and appliances. It has various forms such as thermal (heat), mechanical (work), electrical, and chemical that may be transformed from one into another. Customary unit of measurement is watts (W)

Energy Conservation Building Code (ECBC): the Energy Conservation Building Code as updated from time to time by the Bureau and displayed on its website (www.beeindia.gov.in).

Energy Efficiency Ratio (EER): the ratio of net cooling capacity in kW to total rate of electric input in watts under design operating conditions

Energy recovery system: equipment to recover energy from building or space exhaust air and use it to treat (pre-heat or pre-cool) outdoor air taken inside the building or space by ventilation systems

Envelope Performance Factor (EPF): value for the building envelope performance compliance option calculated using the procedures specified in 4.3.5 and **Error! Reference source not found.** For the purposes of determining building envelope requirements the classifications are defined as follows:

- (a) Standard Building EPF: envelope performance factor calculated for the Standard Building using prescriptive requirements for walls, vertical fenestrations and roofs
- (b) Proposed Building EPF: the building envelope performance factor for the Proposed Building using proposed values for walls, vertical fenestrations and roofs

Energy Performance Index (EPI): of a building means its annual energy consumption in kilowatt-hours per square meter of the area of the building which shall be calculated in the existing or proposed building as per the formula below,

$$= \frac{\text{annual energy consumption in kWh}}{\text{total built – up area (excluding storage area \& parking in basement) in m}^2}$$

EPI Ratio: of a building means the ratio of the EPI of the Proposed Building to the EPI of the Standard Building.

Equipment: mechanical, electrical or static devices for operating a building, including but not limited to those required for providing cooling, heating, ventilation, lighting, service hot water, vertical circulation

Equipment, existing: equipment previously installed in an existing building

Equivalent SHGC: SHGC for a fenestration with a permanent external shading projection. It is calculated using the Projection Factor (PF) of the permanent external shading projection and Shading Equivalent Factor (SEF) listed in §4.3.1.

Exemption: any exception allowed to compliance with ECBC requirements

F

Fan system power: sum of the nominal power demand (nameplate W or HP) of motors of all fans that are required to operate at design conditions to supply air from the heating or cooling source to the conditioned space(s) and return it to the point where it can be exhausted to outside the building.

Fenestration: all areas (including the frames) in the building envelope that let in light, including windows, plastic panels, clerestories, skylights, glass doors that are more than one-half glass, and glass block walls.

- (a) **Skylight:** a fenestration surface having a slope of less than 60 degrees from the horizontal plane. Other fenestration, even if mounted on the roof of a building, is considered vertical fenestration.
- (b) **Vertical fenestration:** all fenestration other than skylights. Trombe wall assemblies, where glazing is installed within 300 mm of a mass wall, are considered walls, not fenestration.

Fenestration area: total area of the fenestration measured using the rough opening and including the glazing, sash, and frame. For doors where the glazed vision area is less than 50% of the door area, the fenestration area is the glazed vision area. For all other doors, the fenestration area is the door area.

Finished floor level: level of floor achieved after finishing materials have been added to the subfloor or rough floor or concrete floor slab.

Fossil fuel: fuel derived from a hydrocarbon deposit such as petroleum, coal, or natural gas derived from living matter of a previous geologic time

Fuel: a material that may be used to produce heat or generate power by combustion

Fuel utilization efficiency (FUE): a thermal efficiency measure of combustion equipment like furnaces, boilers, and water heaters

G

Gathering hall (Type of Assembly): any building, its lobbies, rooms and other spaces connected thereto, primarily intended for assembly of people, but which has no theatrical stage or permanent theatrical and/or cinematographic accessories and has gathering space for greater or equal to 100 persons, for example, stand-alone dance halls, stand-alone night clubs, halls for incidental picture shows, dramatic, theatrical or educational presentation, lectures or other similar purposes having no theatrical stage except a raised platform and used without permanent seating arrangement; art galleries, community halls, marriage halls, places of worship, museums, stand-alone lecture halls, passenger terminals and heritage and archeological monuments, pool and billiard parlors, bowling alleys, community halls, courtrooms, gymnasiums, indoor swimming pools, indoor tennis court, any indoor stadium for sports and culture, auditoriums

Grade: finished ground level adjoining a building at all exterior walls

Guest room: any room or rooms used or intended to be used by a guest for sleeping purposes

H

Habitable spaces: space in a building or structure intended or used for working, meeting, living, sleeping, eating, or cooking. Bathrooms, water closet compartments, closets, halls, storage or utility space, and similar areas are not considered habitable spaces.

Heat capacity: amount of heat necessary to raise the temperature of a given mass by 1°C. Numerically, the heat capacity per unit area of surface ($W/m^2.K$) is the sum of the products of the mass per unit area of each individual material in the roof, wall, or floor surface multiplied by its individual specific heat.

Hospitals and sanatoria (Healthcare): Any building or a group of buildings under single management, which is used for housing persons suffering from physical limitations because of health or age and those incapable of self-preservation, for example, any hospitals, infirmaries, sanatoria and nursing homes.

HVAC system: equipment, distribution systems, and terminal devices that provide, either collectively or individually, the processes of heating, ventilating, or air conditioning to a building or parts of a building.

Hyper Markets (Type F of Shopping Complex): large retail establishments that are a combination of supermarket and department stores. They are considered as a one-stop shop for all needs of the customer.

I

Infiltration: uncontrolled inward air leakage through cracks and crevices in external surfaces of buildings, around windows and doors due to pressure differences across these caused by factors such as wind or indoor and outside temperature differences (stack effect), and imbalance between supply and exhaust air systems

Installed interior lighting power: power in watts of all permanently installed general, task, and furniture lighting systems and luminaires

Integrated part-load value (IPLV): weighted average efficiency of chillers measured when they are operating at part load conditions (less than design or 100% conditions). It is more realistic measurement of chiller efficiency during its operational life.

K

Kilovolt-ampere (kVA): where the term “kilovolt-ampere” (kVA) is used in this Code, it is the product of the line current (amperes) times the nominal system voltage (kilovolts) times 1.732 for three-phase currents. For single-phase applications, kVA is the product of the line current (amperes) times the nominal system voltage (kilovolts).

Kilowatt (kW): the basic unit of electric power, equal to 1000 W.

L

Labeled: equipment or materials to which a symbol or other identifying mark has been attached by the manufacturer indicating compliance with specified standard or performance in a specified manner.

Lamp: a generic term for man-made light source often called bulb or tube

Lighted floor area, gross: gross area of lighted floor spaces

Lighting, emergency: battery backed lighting that provides illumination only when there is a power outage and general lighting luminaires are unable to function.

Lighting, general: lighting that provides a substantially uniform level of illumination throughout an area. General lighting shall not include decorative lighting or lighting that provides a dissimilar level of illumination to serve a specialized application or feature within such area.

Lighting system: a group of luminaires circuited or controlled to perform a specific function.

Lighting power allowance:

- (a) Interior lighting power allowance: the maximum lighting power in watts allowed for the interior of a building
- (b) Exterior lighting power allowance: the maximum lighting power in watts allowed for the exterior of a building

Lighting Power Density (LPD): maximum lighting power per unit area of a space as per its function or building as per its classification.

Low energy comfort systems: space conditioning or ventilation systems that are less energy intensive than vapor compression based space conditioning systems. These primarily employ alternate heat transfer methods or materials (adiabatic cooling, radiation, desiccant, etc.), or renewable sources of energy (solar energy, geo-thermal) so that minimal electrical energy input is required to deliver heating or cooling to spaces.

Luminaires: a complete lighting unit consisting of a lamp or lamps together with the housing designed to distribute the light, position and protect the lamps, and connect the lamps to the power supply.

Luminous Efficacy (LE): total luminous flux (visible light) emitted from a lamp or lamp/ballast combination divided by input power, expressed in lumens per Watt.

M

Man-made daylight obstruction: any permanent man-made object (equipment, adjacent building) that obstructs sunlight or solar radiation from falling on a portion or whole of a building's external surface at any point of time during a year is called as a man-made sunlight obstructer.

Manual (non-automatic): requiring personal intervention for control. Non-automatic does not necessarily imply a manual controller, only that personal intervention is necessary.

Manufacturing processes: processes through which raw material is converted into finished goods for commercial sale using machines, labor, chemical or biological processes, etc.

Manufacturer: company or person or group of persons who produce and assemble goods or purchases goods manufactured by a third party in accordance with their specifications.

Mean temperature: average of the minimum daily temperature and maximum daily temperature.

Mechanical cooling: reducing the temperature of a gas or liquid by using vapor compression, absorption, and desiccant dehumidification combined with evaporative cooling, or another energy-driven thermodynamic cycle. Indirect or direct evaporative cooling alone is not considered mechanical cooling.

Metering: practice of installing meters in buildings to acquire data for energy consumption and other operational characteristics of individual equipment or several equipment grouped on basis of their function (lighting, appliances, chillers, etc.). Metering is done in buildings to monitor their energy performance.

Mixed mode air-conditioned building: building in which natural ventilation is employed as the primary mode of ventilating the building, and air conditioning is deployed as and when required.

Mixed use development: a single building or a group of buildings used for a combination of residential, commercial, business, educational, hospitality and assembly purposes

N

National Building Code 2016 (NBC): model building code that provides guidelines for design and construction of buildings. In this code, National Building Code 2016 refers to the latest version by the Bureau of Indian Standards.

Natural daylight obstruction: any natural object, like tree, hill, etc., that obstructs sunlight from falling on part or whole of a building's external surface at any point of time during a year and casts a shadow on the building surface.

Naturally ventilated building: a building that does not use mechanical equipment to supply air to and exhaust air from indoor spaces. It is primarily ventilated by drawing and expelling air through operable openings in the building envelope.

Non-cardinal directions: any direction which is not a cardinal direction, i.e. perfect north, south, east, or west, is termed as non-cardinal direction.

No Star hotel (Type of Hospitality): any building or group of buildings under the same management, in which separate sleeping accommodation on commercial basis, with or without dining facilities or cooking facilities, is provided for individuals. This includes lodging rooms, inns, clubs, motels, no star hotel and guest houses and excludes residential apartments rented on a lease agreement of 4 months or more. These shall also include any building in which group sleeping accommodation is provided, with or without dining facilities for persons who are not members of the same family, in one room or a series of adjoining rooms under joint occupancy and single management, for example, school and college dormitories, students, and other hostels and military barracks.

O

Occupant sensor: a device that detects the presence or absence of people within an area and causes lighting, equipment, or appliances to be dimmed, or switched on or off accordingly.

Opaque assembly or opaque construction: surface of the building roof or walls other than fenestration and building service openings such as vents and grills.

Opaque external wall: external wall composed of materials which are not transparent or translucent, usually contains the structural part of the building, and supports the glazed façade. This type may be composed of one or more materials, and can accommodate various physical processes at a time, as the insulation and thermal inertia.

Open Gallery Mall (Type of Shopping Complex): a large retail complex containing a variety of stores and often restaurants and other business establishments housed in a series of connected or adjacent buildings or in a single large building. The circulation area and atrium of the open gallery mall is an unconditioned space and is open to sky.

Orientation: the direction a building facade faces, i.e., the direction of a vector perpendicular to and pointing away from the surface of the facade. For vertical fenestration, the two categories are north-oriented and all other.

Outdoor (outside) air: air taken from the outside the building and has not been previously circulated through the building.

Out-patient Healthcare (Type of Healthcare): any building or a group of buildings under single management, which is used only for treating persons requiring treatment or diagnosis of disease but not requiring overnight or longer accommodation in the building during treatment or diagnosis.

Overcurrent: any current in excess of the rated current of the equipment of the ampacity of the conductor. It may result from overload, short circuit, or ground fault.

Owner: a person, group of persons, company, trust, institute, Registered Body, state or central Government and its attached or sub-ordinate departments, undertakings and like agencies or organization in whose name the property stands registered in the revenue records for the construction of a building or building complex

P

Party wall: a firewall on an interior lot line used or adapted for joint service between two buildings.

Permanently installed: equipment that is fixed in place and is not portable or movable.

Plenum: a compartment or chamber to which one or more ducts are connected, that forms a part of the air distribution system, and that is not used for occupancy or storage.

Plug loads: energy used by products that are powered by means of an AC plug. This term excludes building energy that is attributed to major end uses specified in § Error! Reference source not found., § Error! Reference source not found., § 0 (like HVAC, lighting, water heating, etc.).

Pool: any structure, basin, or tank containing an artificial body of water for swimming, diving, or recreational bathing. The terms include, but no limited to, swimming pool, whirlpool, spa, hot tub.

Potential daylight time: amount of time in a day when there is daylight to light a space adequately without using artificial lighting. Potential daylight time is fixed for 8 hours per day i.e. from 09:00 AM to 5:00 PM local time, resulting 2920 hours in total for all building types except for Type E-1 - Educational, which shall be analyzed for 7 hours per day i.e. from 08:00 AM to 3:00 PM local time.

Primary inter-cardinal direction: any of the four points of the compass, midway between the cardinal points; northeast, southeast, southwest, or northwest are called primary inter-cardinal direction.

Process load: building loads resulting from the consumption or release of energy due to industrial processes or processes other than those for providing space conditioning, lighting, ventilation, or service hot water heating.

Projection factor, overhang: the ratio of the horizontal depth of the external shading projection to the sum of the height of the fenestration and the distance from the top of the fenestration to the bottom of the farthest point of the external shading projection, in consistent units.

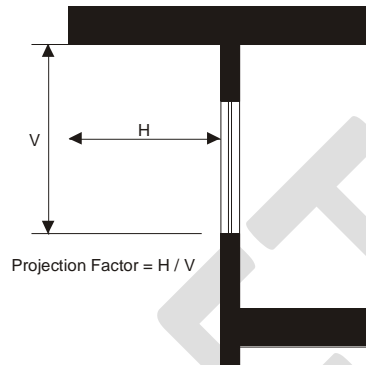

Projection factor, side fin: the ratio of the horizontal depth of the external shading projection to the distance from the window jamb to the farthest point of the external shading projection, in consistent units.

Projection Factor, overhang and side fin: average of ratio projection factor for overhang only and projection factor of side fin only.

Proposed Building: is consistent with the actual design of the building and complies with all the mandatory requirements of ECBC.

Proposed Design: a computer model of the proposed building, consistent with its actual design, which complies with all the mandatory requirements of ECBC.

R

R-value (thermal resistance): the reciprocal of the time rate of heat flow through a unit area induced by a unit temperature difference between two defined surfaces of material or construction under steady-state conditions. Units of R value are $m^2.K / W$.

Readily accessible: capable of being reached quickly for operation, renewal, or inspections without requiring those to whom ready access is requisite to climb over or remove obstacles or to resort to portable ladders, chairs, etc. In public facilities, accessibility may be limited to certified personnel through locking covers or by placing equipment in locked rooms.

Recirculating system: a domestic or service hot water distribution system that includes a close circulation circuit designed to maintain usage temperatures in hot water pipes near terminal devices (e.g., lavatory faucets, shower heads) in order to reduce the time required to obtain hot water when the terminal device valve is opened. The motive force for circulation is either natural (due to water density variations with temperature) or mechanical (recirculation pump).

Reflectance: ratio of the light or radiation reflected by a surface to the light or radiation incident upon it.

Renewable Energy Generating Zone: a contiguous or semi-contiguous area, either on rooftop or elsewhere within site boundary, dedicated for installation of renewable energy systems.

Resort (Type of Hospitality): commercial establishments that provide relaxation and recreation over and above the accommodation, meals and other basic amenities. The characteristics of resort are as below –

- i. Includes 1 or more recreation(s) facility like spa, swimming pool, or any sport;
- ii. Is located in the midst of natural and picturesque surroundings outside the city;
- iii. Comprises of 2 or more blocks of buildings within the same site less than or equal to 3 floors (including the ground floor).

Reset: automatic adjustment of the controller set point to a higher or lower value.

Roof: the upper portion of the building envelope, including opaque areas and fenestration, that is horizontal or tilted at an angle of less than 60° from horizontal. This includes podium roof as well which are exposed to direct sun rays.

Roof area, gross: the area of the roof measured from the exterior faces of walls or from the centerline of party walls

S

Selectivity ratio of a glass: ratio between light transmission and solar factor of glass.

Service: the equipment for delivering energy from the supply or distribution system to the premises served.

Service water heating equipment: equipment for heating water for domestic or commercial purposes other than space heating and process requirements.

Set point: the desired temperature (°C) of the heated or cooled space that must be maintained by mechanical heating or cooling equipment.

Shading Coefficient (SC): measure of thermal performance of glazing. It is the ratio of solar heat gain through glazing due to solar radiation at normal incidence to that occurring through 3 mm thick clear, double-strength glass. Shading coefficient, as used herein, does not include interior, exterior, or integral shading devices.

Shading Equivalent Factor: coefficient for calculating effective SHGC of fenestrations shaded by overhangs or side fins.

Shopping Mall (Shopping Complex): a large retail complex containing a variety of stores and often restaurants and other business establishments housed in a series of connected or adjacent buildings or in a single large building. The circulation area and atrium of the mall is an enclosed space covered completely by a permanent or temporary structure.

Simulation program: software in which virtual building models can be developed to simulate the energy performance of building systems.

Single-zone system: an HVAC system serving a single HVAC zone.

Site-recovered energy: waste energy recovered at the building site that is used to offset consumption of purchased fuel or electrical energy supplies.

Slab-on-grade floor: floor slab of the building that is in contact with ground and that is either above grade or is less than or equal to 300 mm below the final elevation of the nearest exterior grade.

Soft water: water that is free from dissolved salts of metals such as calcium, iron, or magnesium, which form insoluble deposits on surfaces. These deposits appear as scale in boilers or soap curds in bathtubs and laundry equipment.

Solar energy source: source of thermal, chemical, or electrical energy derived from direction conversion of incident solar radiation at the building site.

Solar Heat Gain Coefficient (SHGC): the ratio of the solar heat gain entering the space through the fenestration area to the incident solar radiation. Solar heat gain includes directly transmitted solar heat and absorbed solar radiation, which is then reradiated, conducted, or convected into the space.

Space: an enclosed area within a building. The classifications of spaces are as follows for purpose of determining building envelope requirements:

- (a) Conditioned space: a cooled space, heated space, or directly conditioned space.
- (b) Semi-heated space: an enclosed space within a building that is heated by a heating system whose output capacity is greater or equal to 10.7 W/m^2 but is not a conditioned space.
- (c) Non-conditioned space: an enclosed space within a building that is not conditioned space or a semi-heated space. Crawlspace, attics, and parking garages with natural or mechanical ventilation are not considered enclosed spaces.

Star Hotels/motels (Star Hotel): any building or group of buildings under single management and accredited as a starred hotel by the Hotel and Restaurant Approval and Classification Committee, Ministry of Tourism, in which sleeping accommodation, with or without dining facilities is provided.

Stand-alone Retail (Shopping Complex): a large retail store owned or sublet to a single management which may offer customers a variety of products under self-branding or products of different brands. The single management shall have a complete ownership of all the spaces of the building and no space within the building is further sold or sublet to a different management.

Standard Building: a building that minimally complies with all the mandatory and prescriptive requirements of Energy Conservation Building Code and has same floor area, gross wall area, and gross roof area of the Proposed Building.

Standard Design: a computer model of a hypothetical building, based on actual building design, that fulfills all the mandatory requirements and minimally complies with the prescriptive requirements of ECBC, as described in the Whole Building Performance method.

Story: portion of a building that is between one finished floor level and the next higher finished floor level or building roof. Basement and cellar shall not be considered a story.

Summer Solar Insolation: measure of solar radiation energy received on a given surface area from the month of March to October within the same calendar year. Units of measurement are watts per square meter (W/m^2) or kilowatt-hours per square meter per day ($kW \cdot h / (m^2 \cdot \text{day})$) (or hours/day).

SuperECBC Building: a building that complies with the mandatory requirements of §4 to §7 and also complies either with the prescriptive requirements stated under the SuperECBC Building categories of §4 to §7, or, with the whole building performance compliance method of §9. This is a voluntary level of compliance with ECBC.

Super Market (Shopping Complex): supermarkets are large self-service grocery stores that offer customers a variety of foods and household supplies. The merchandise is organized into an organized aisle format, where each aisle has only similar goods placed together.

System: a combination of equipment and auxiliary devices (e.g., controls, accessories, interconnecting means, and terminal elements) by which energy is transformed so it performs a specific function such as HVAC, service water heating, or lighting.

System Efficiency: the system efficiency is the ratio of annual kWh electricity consumption of equipment of water cooled chilled water plant (i.e. chillers, chilled and condenser water pumps, cooling tower) to chiller thermal kWh used in a building.

System, existing: a system or systems previously installed in an existing building.

T

Tenant lease agreement: The formal legal document entered into between a Landlord and a Tenant to reflect the terms of the negotiations between them; that is, the lease terms have been negotiated and agreed upon, and the agreement has been reduced to writing. It constitutes the entire agreement between the parties and sets forth their basic legal rights.

Tenant leased area: area of a building that is leased to tenant(s) as per the tenant lease agreement.

Terminal device: a device through which heated or cooled air is supplied to a space to maintain its temperature. It usually contains dampers and heating and cooling coils. Or a device by which energy from a system is finally delivered, e.g., registers, diffusers, lighting fixtures, faucets, etc.

Theater or motion picture hall (Type of Assembly): any building primarily meant for theatrical or operatic performances and which has a stage, proscenium curtain, fixed or portable scenery or scenery loft, lights, mechanical appliances or other theatrical accessories and equipment for

example, theaters, motion picture houses, auditoria, concert halls, television and radio studios admitting an audience and which are provided with fixed seats.

Thermal block: a collection of one or more HVAC zones grouped together for simulation purposes. Spaces need not be contiguous to be combined within a single thermal block.

Thermal comfort conditions: conditions that influence thermal comfort of occupants. Environmental conditions that influence thermal comfort air and radiant temperature, humidity, and air speed.

Thermostat: device containing a temperature sensor used to automatically maintain temperature at a desirable fixed or adjustable set point in a space.

Tinted: (as applied to fenestration) bronze, green, or grey coloring that is integral with the glazing material. Tinting does not include surface applied films such as reflective coatings, applied either in the field or during the manufacturing process.

Transformer: a piece of electrical equipment used to convert electric power from one voltage to another voltage.

Transformer losses: electrical losses in a transformer that reduces its efficiency.

Transport Buildings (Assembly): any building or structure used for the purpose of transportation and transit like airports, railway stations, bus stations, and underground and elevated mass rapid transit system example, underground or elevated railways.

U

Unconditioned buildings: building in which more than 90% of spaces are unconditioned spaces.

Unconditioned space: mechanically or naturally ventilated space that is not cooled or heated by mechanical equipment.

Universities and all others coaching/training institutions (Educational): a building or a group of buildings, under single management, used for imparting education to students numbering more than 100 or public or private training institution built to provide training/coaching etc.

Useful Daylight Illuminance: percentage of annual daytime hours that a given point on a work plane height of 0.8 m above finished floor level receives daylight between 100 lux to 2,000 lux.

U-factor (Thermal Transmittance): heat transmission in unit time through unit area of a material or construction and the boundary air films, induced by unit temperature difference between the environments on each side. Unit of U value is $W/m^2.K$.

V

Variable Air Volume (VAV) system: HVAC system that controls the dry-bulb temperature within a space by varying the volumetric flow of heated or cooled air supplied to the space

Vegetative roofs: also known as green roofs, they are thin layers of living vegetation installed on top of conventional flat or sloping roofs.

Ventilation: the process of supplying or removing air by natural or mechanical means to or from any space. Such air is not required to have been conditioned.

Vision Windows: windows or area of large windows that are primarily for both daylight and exterior views. Typically, their placement in the wall is between 1 meter and 2.2 meter above the floor level.

W

Wall: that portion of the building envelope, including opaque area and fenestration, that is vertical or tilted at an angle of 60° from horizontal or greater. This includes above- and below-grade walls, between floor spandrels, peripheral edges of floors, and foundation walls.

- (a) Wall, above grade: a wall that is not below grade
- (b) Wall, below grade: that portion of a wall in the building envelope that is entirely below the finish grade and in contact with the ground

Wall area, gross: the overall area off a wall including openings such as windows and doors measured horizontally from outside surface to outside service and measured vertically from the top of the floor to the top of the roof. If roof insulation is installed at the ceiling level rather than the roof, then the vertical measurement is made to the top of the ceiling. The gross wall area includes the area between the ceiling and the floor for multi-story buildings.

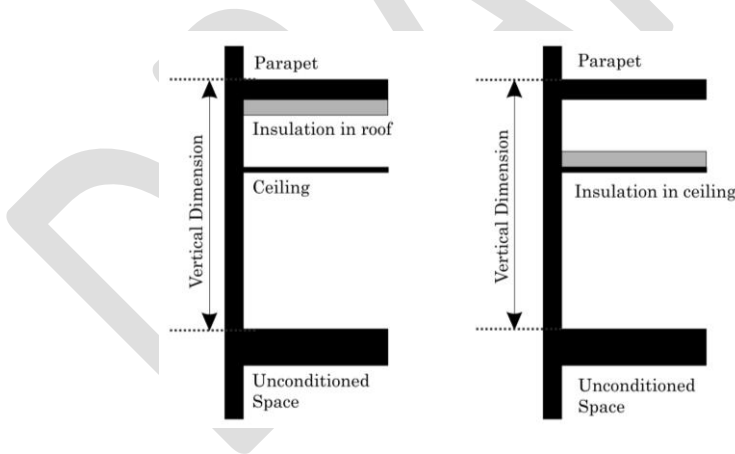

Water heater: vessel in which water is heated and withdrawn for use external to the system.

Z

Zone, HVAC: a space or group of spaces within a building with heating and cooling requirements that are sufficiently similar so that desired conditions (e.g., temperature) can be maintained throughout using a single sensor (e.g., thermostat or temperature sensor).

8.3 SI to IP Conversion Factors

SI Unit	IP Unit
1 cmh	1.7 cfm
1 Pa	0.0040 inch of water gauge
1m	3.28 ft
1m	39.37 in
1mm	0.039 in
1 l/s	2.12 cfm
1 m ²	10.76 ft ²
1 W/m ²	10.76 W/ ft ²
1 W/ lin m	3.28 W/ ft
1 W/m ² .K	5.678 Btu/ h-ft ² -°F
1 W/ l-s ⁻¹	0.063 W/ gpm
1 m ² .K/W	0.1761 ft ² -h-°F/ Btu
1 °C	((°C X 9/5) + 32) °F
1 kW _r	0.284 TR
1 kW	1.34 hp
1 kW	3412.142 Btu/hr

8.4 Abbreviations and Acronyms

AFUE	Annual fuel utilization efficiency
AHRI	Air-conditioning, Heating and Refrigeration Institute
ANSI	American National Standards Institute
ARI	Air-Conditioning and Refrigeration Institute
ASHRAE	American Society of Heating, Refrigerating and Air-Conditioning Engineers
ASTM	American Society for Testing and Materials
BIS	Bureau of Indian Standards
Btu	British thermal unit
Btu/h	British thermal units per hour
Btu/h-ft ² -°F	British thermal units per hour per square foot per degree Fahrenheit

BUA	Built up area
C	Celsius
cmh	cubic meter per hour
cm	centimeter
COP	coefficient of performance
DEF	daylight extent factor
EER	energy efficiency ratio
EPI	energy performance index
F	Fahrenheit
ft	foot
h	hour
h-ft ² -°F/Btu	hour per square foot per degree Fahrenheit per British thermal unit
h-m ² -°C/W	hour per square meter per degree Celsius per Watt
hp	horsepower
HVAC	heating, ventilation, and air conditioning
I-P	inch-pound
in.	inch
IPLV	integrated part-load value
IS	Indian Standard
ISO	International Organization for Standardization
kVA	kilovolt-ampere
kW	Kilowatt of electricity
kW _r	kilowatt of refrigeration
kWh	kilowatt-hour
l/s	liter per second
LE	luminous efficacy
lin	linear
lin ft	linear foot
lin m	linear meter
lm	lumens
Lm/W	lumens per watt
LPD	lighting power density
m	meter
mm	millimeter

m ²	square meter
m ² .K/W	square meter Kelvin per watt
NBC	National Building Code 2016
Pa	pascal
PF	projection factor
R	R-value (thermal resistance)
SC	shading coefficient
SEF	Shading equivalent factor
SHGC	solar heat gain coefficient
TR	tons of refrigeration
UPS	uninterruptible power supply
VAV	variable air volume
VLT	visible light transmission
W	watt
W/ l-s ⁻¹	watt per litre per second
W/m ²	watts per square meter
W/m ² .K	watts per square meter per Kelvin
W/m ²	watts per hour per square meter
W/m.K	watts per lineal meter per Kelvin
Wh	watthour

9 Whole Building Performance Method

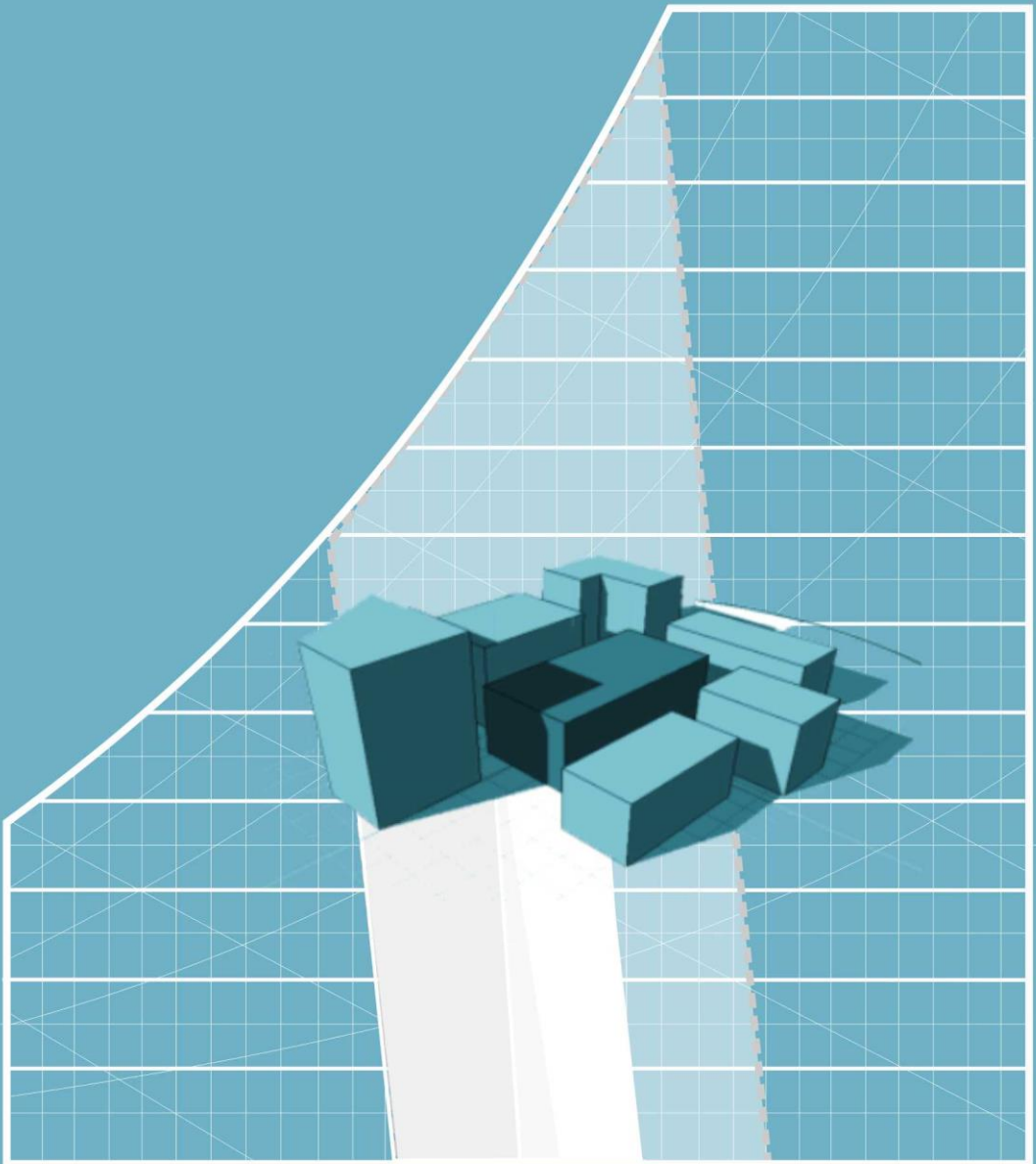

WHOLE BUILDING PERFORMANCE METHOD

INTENT

The Whole Building Performance (WBP) method overcomes the limitations of the prescriptive method of compliance. Specifically, WBP Method may be used when some individual components of the Proposed Building do not meet the prescriptive requirements of the Code, but the remaining components far exceed the Code requirements. The latter, then, 'compensate' for the lower performance of the former components, and the building may comply with the Code considering its overall energy use. The WBP method requires the use of computer simulations to show compliance. This chapter enumerates all the requirements with respect to creating the energy model for compliance.

SECTION ORGANIZATION

MANDATORY REQUIREMENTS

SIMULATION
REQUIREMENTS

CALCULATING ENERGY
CONSUMPTION OF PROPOSED
DESIGN AND STANDARD DESIGN

MAXIMUM ALLOWED EPI RATIOS

SCHEDULES

9. WHOLE BUILDING PERFORMANCE METHOD

9.1 General

The annual energy performance of a proposed (or existing) building can be predicted by using energy simulation software. To analyze a building using the Whole Building Performance (WBP) Method, a detailed computer model of the proposed building needs to be prepared using a building simulation software. The model must accurately (to the extent possible) represent the building location, occupancy, schedules, geometry, thermal properties, heating and cooling systems, and plants. The energy use of the Proposed Design is then calculated using a weather file that contains hourly weather data for the given location.

Methodology

In another iteration (called the Standard Design), parameters of the Proposed Design are modified according to the rules specified in Table 9-1. Unless specified in this table, all building systems and equipment are modeled identically in the Standard Design and Proposed Design. The Proposed Design and Standard are simulated for all 8,760 hours of a year using the hourly values of climatic data, such as temperature and humidity, from representative climatic data for the city in which the Proposed Design is to be located. For cities or urban regions with several climate data entries, and for locations where weather data are not available, weather data that best represents the climate at the construction site may be selected. EPIs for the Standard Design and Proposed Design are

obtained from the output file of the models (the equations are included below).

Benefits

The WBP Method provides a detailed and robust analysis of the thermal performance of building. Whole building energy simulation is currently the most sophisticated way of analyzing the impact of energy efficiency measures in an integrated manner. It is an alternative to the prescriptive requirements contained in §4 to §8 of ECBC. The impact of changing any one of the myriad parameters affecting energy performance of the building design being modeled can be predicted using this method. This is particularly useful for studying the impact of combinations of energy efficiency measures that may lead to non-linear building energy outcomes.

For example, electric lights produce light and heat inside a space. Calculating the electrical consumption for the electric lights is not very difficult, as long as one knows how many lights there are, what their heat output is, and how many hours they run. One does not need a simulation model to predict this outcome. However, the heat generated by electric lighting has to be removed by the HVAC systems in a warm or hot climate. Calculating the reduction in energy used by the HVAC systems due to the use of a more efficient electric lighting system is not recommended through manual calculations.

This computation becomes significantly more complex if the design team decides to employ a daylight linked electric lighting system. Such a system is designed to reduce light (and heat output) in a space when enough daylight is available. This non-linear relationship impacts the electric energy input to the lighting system, and the heat removed by the HVAC system.

$$EPI = \frac{\text{annual energy consumption in kWh}}{\text{total built – up area (excluding unconditioned basements)}}$$

(see 3.1.1 Energy Performance Index)

$$EPI \text{ Ratio} = \frac{EPI \text{ of Proposed Building}}{EPI \text{ of Standard Building}}$$

(see 3.1.2 Determining EPI Ratio)

At this time, predicting the integrated energy performance resulting from complex energy efficiency strategies cannot be studied reliably by any other means except the use of a whole building energy simulation analysis.

Once the model is completed and a base run is established, carrying out multiple runs to test alternate design options involves less effort on the part of the analyst, although there could still be substantial computer run time involved. Whole building energy simulation is increasingly being used for testing compliance with various building energy codes and sustainability rating tools such as LEED and GRIHA. Technically reliable and verifiable energy simulation programs satisfying the minimum modeling capabilities (specified in §9.3 below) should be used for compliance using this verification method.

9.1.1 Scope

The Whole Building Performance Method is an alternative to the Prescriptive Method compliance path contained in §4 through §7 of this Code. It applies to all building types covered by the Code as mentioned in §2.5.

In general, the WBP Method may be used to show compliance with the ECBC for any project at the designer’s discretion, subject to the following caveats and exceptions. Specifically, WBP Method may be used when some individual components of the Proposed Building do not meet the prescriptive requirements of the Code,

but the remaining components far exceed the Code requirements. The latter, then, ‘compensate’ for the lower performance of the former components, and the building may comply with the Code considering its overall energy use.

It must be noted here that mandatory provisions of the Code must be met at all times, while using the WBP Method as well. For example, if the WWR of the Proposed Building exceeds 40%, compliance cannot be demonstrated using the prescriptive requirements. The WBP Method may be used, wherein other more efficient components of the building may make up for increased WWR.

WHILE USING THE WBP METHOD,
MANDATORY PROVISIONS OF THE CODE
MUST BE MET AT ALL TIMES

No HVAC System

Use of the WBP method requires knowledge of the proposed HVAC system in order to create the Standard Design. Buildings with no HVAC system cannot use the WBP Method. In the case of a shell building, which might become conditioned in the future, trade-offs may still be made within the envelope system.

Alterations to Existing Buildings

When the WBP method is used for an alteration of an existing building, some special rules apply. The WBP method is optional for this purpose;

designers may use the calculation acceptable to the Authority Having Jurisdiction. Unless a building component is being altered, the Proposed Design and the Standard Design are identical for that component. Portions of the building that are being replaced shall be treated as new systems and these systems in the Standard Design shall be representative of the requirements in the ECBC.

Alterations and Additions

The basic rules for alterations and additions are discussed in §3.3 of the ECBC User Guide. There are some more rules that apply to cases where it is undesirable either to treat the addition as a stand-alone building or to fully model the entire existing building. It is often necessary with additions or alterations to model at least part of the existing building. For instance, if the existing building's HVAC system is being extended to serve the new construction, then that system needs to be fully modeled in order to account for its energy performance. If, however, this system only serves a portion of the existing building and only part of that building is affected by the new work, then it is not necessary to model the entire existing building.

Parts of Existing Buildings

The rules for excluding parts of the existing building are as follows:

- If there is new construction that comes under the ECBC scope and it is part of the existing building but will be excluded from the Proposed Design, then those parts must comply with the Code's applicable prescriptive requirements.
- The excluded parts of the existing building must be served by HVAC systems that are completely independent of the systems or building components being modeled for the Proposed Building.
- There should not be any significant energy flows between the excluded parts of the

building and the modeled parts. Rephrasing, the design space temperature, HVAC system operating set points, and operating and occupancy schedules on both sides of the boundary between the included and excluded parts must be the same. If the excluded portion of the building is a refrigerated warehouse and the included portion is an office, this condition would not be met, because there would be significant energy flows between them.

9.1.2 Compliance

[A building complies with the Code using the Whole Building Performance \(WBP\) Method, when the estimated EPI Ratio is equal to or less than 1, even though it may not comply with the specific provisions of the prescriptive requirements in §4 through §7. The mandatory requirements of §4 through §7 \(§4.2, §5.2, §6.2 and §7.2\) shall be met when using the WBP Method](#)

Compliance of the Proposed Design with the requirements of the ECBC Whole Building Performance Method consists of the following steps:

- 1) Developing a Standard Design simulation model
- 2) Carrying out a valid energy simulation run using the Standard Design to predict its annual energy use
- 3) Developing the Proposed Design simulation model for which compliance is being sought
- 4) Carrying out a valid energy simulation run for the Proposed Design model and ensuring that the predicted annual energy use is less than or equal to the energy use in Standard Design

The major consideration for generating the Standard Design simulation model is that it complies with the minimum performance requirements specified in the ECBC.

Much of the remainder of this chapter is addressed towards the development of the Standard and Proposed Designs. The following sections describe how decisions are to be taken for each of the two designs, and how these two simulation runs are to be done, but the following rules always apply:

- Mandatory provisions of the Code mentioned in §4 through section §8 are met
- Both simulation runs must use the same simulation program
- Both simulation runs must use the same climate data
- Both simulation runs must use the same schedules of operation

These rules ensure a fair comparison between the two runs, without introducing extraneous differences. For instance, if the runs used different simulation programs, then some portion of the differences between the resulting energy consumption would be due to differences in algorithms or calculation methodologies making it difficult to evaluate the impact of the two designs on energy use.

The WBP method provides the building owner and design team with the flexibility to try out different design options, provided the end result is a building that does not have higher annual energy consumption than if it would have met all the prescriptive requirements. For example, the owner may decide to invest in a more efficient lighting system in place of larger glazing areas or invest in high performance glazing to avoid the cost of installing an economizer and get the benefits of daylighting.

9.1.3 Annual Energy Use

Annual energy use for the purposes of the WBP Method shall be calculated in kilowatt-hours (kWh) of electricity use per year per unit area. Energy sources other than electricity that are used in the building shall be converted to kWh of

electric energy at the rate of 0.75 kWh per megajoule.

Note: The annual energy use calculation as per the Whole Building Performance Method is not a prediction of the actual energy use of the building once it gets operational. Actual energy performance of a building depends on a number of factors like weather, occupant behaviour, equipment performance and maintenance, among others, which are not covered by this Code.

9.1.4 Trade-offs Limited to Building Permit

The WBP Method may be used for building permit applications that include less than the whole building; however, any design parameters that are not part of the building permit application shall be identical for both the Proposed Design and the Standard Design. Future improvements to the building shall comply with both the mandatory and prescriptive requirements of concurrent code.

9.1.5 Documentation Requirements

Compliance shall be documented, and compliance forms shall be submitted to the authority having jurisdiction. The information submitted shall include, at a minimum, the following:

- a) Summary describing the results of the analysis, including the annual energy use for the Proposed Design and the Standard Design, and software used.
- b) Brief description of the project with location, number of stories, space types, conditioned and unconditioned areas, hours of operation.
- c) List of the energy-related building features of the Proposed Design. This list shall also

document features different from the Standard Design.

- d) List showing compliance with the mandatory requirements of this code.
- e) The input and output report(s) from the simulation program including a breakdown of energy usage by at least the following components: lights, internal equipment loads, service water heating equipment, space heating equipment, space cooling and heat rejection equipment, fans, and other HVAC equipment (such as pumps). The output reports shall also show the number of hours any loads are not met by the HVAC system for both the Proposed Design and Standard Design.
- f) Explanation of any significant modelling assumptions made.
- g) Explanation of any error messages noted in the simulation program output.
- h) Building floor plans, building elevations, and site plan.

9.2 Mandatory Requirements

All requirements of §Error! Reference source not found., §Error! Reference source not found., §Error! Reference source not found., and §Error! Reference source not found. shall be met. These sections contain the mandatory provisions of the Code and are prerequisites for demonstrating compliance using the WBP Method.

9.3 Simulation Requirements

9.3.1 Energy Simulation Program

The simulation software shall be a computer-based program for the analysis of energy consumption in buildings and be approved by the authority having jurisdiction. The simulation

program shall, at a minimum, have the ability to model the following:

- a) Energy flows on an hourly basis for all 8,760 hours of the year,
- b) Hourly variations in occupancy, lighting power, miscellaneous equipment power, thermostat set points, and HVAC system operation, defined separately for each day of the week and holidays,
- c) Thermal mass effects,
- d) Ten or more thermal zones,
- e) Part-load and temperature dependent performance of heating and cooling equipment,
- f) Air-side and water-side economizers with integrated control.

In addition to the above, the simulation tool shall be able to produce hourly reports of energy use by energy source and shall have the capability to performing design load calculations to determine required HVAC equipment capacities, air, and water flow rates in accordance with §Error! Reference source not found. for both the proposed and Standard building designs

The simulation program shall be tested according to ASHRAE Standard 140 Method of Test for the Evaluation of Building Energy Analysis Computer Programs (ANSI approved) and the results shall be furnished by the software provider.

WBP Method uses the output of a simulation program to demonstrate that the Proposed Design complies with the ECBC. In order to make sure that these calculations are sufficiently accurate for the purposes of the Code, a series of requirements have been set. The most basic requirement is that the simulation program be a computer-based program designed to analyze energy consumption in buildings, and that it has the capability to model the features of the

Proposed Design. A building energy simulation model comprises of a detailed description of the building geometry and materials of construction.

Building Model

Much of the effort in developing the model for an energy simulation analysis is in describing building geometry. This includes

- Describing the overall building envelope and geometry, ie., number of floors, orientation
- Describing physical and thermal properties for the construction of each building element
- Describing the location, size and the thermal, optical and solar properties of windows
- Describing permanent shading devices attached to the building, automatic window blinds and details of their operation
- Describing objects that might cast shadow on the building being simulated, e.g., surrounding buildings
- Describing spaces or “thermal zones” and their relative location, and relationship with the HVAC system design for the building

Minimum Modeling Capabilities

This defines the minimum set of capabilities for WBP method simulation programs. These have been broadly defined to allow all complying programs to be considered for approval by the Authority Having Jurisdiction, while eliminating programs that would not be able to adequately account for the energy performance of building features important under the Code. These minimum capabilities are:

- **Approved Simulation Program:** The simulation program should be subjected to the International Energy Agency BESTEST (Building Energy Simulation Test and

Diagnostic Method) or the ANSI/ ASHRAE Standard 140-2004, Standard Method of Test for the Evaluation of Building Energy Analysis Computer Programs.

- **Minimum Hours per Year:** Programs must be able to model energy flows on an hourly basis for the entire year (8,760 hours).
- **Hourly Variations:** Building loads and system operations vary hour-by-hour, and their interactions have a great influence on building energy performance. Approved programs must have the capability to model hourly variations – and to establish separately designed schedules of operation for each day of the week and for holidays – for occupancy, lighting power, miscellaneous equipment power, thermostat set points, and HVAC system operation.
- **Thermal Mass Effects:** A building’s ability to absorb and hold heat varies with the type of construction and with the system and ventilation characteristics. This affects the timing and magnitude of loads handled by the HVAC system. Simulation programs must be able to model these thermal mass effects.
- **Number of Thermal Zones:** There are multiple thermal zones in all but the simplest buildings, and they experience different load patterns. Approved programs must be able to model at least 10 thermal zones; many simulation programs can handle far greater number of zones.
- **Part-Load Performance:** Mechanical equipment seldom experiences full-load operating conditions, so the performance of this equipment under part-load conditions is important. Approved programs must incorporate part-load performance curves in their calculations.
- **Correction Curves:** The efficiency of the mechanical equipment varies depending on temperature and humidity conditions. Approved programs must incorporate

efficiency correction curves for mechanical heating and cooling equipment.

- Economizers: Economizer cooling is an important efficiency measure under the Standard. Approved programs must have the capability to model both airside and waterside economizers with integrated control.
- Design Load Calculations: Approved programs must be capable of performing design load calculations to determine required HVAC equipment capacities and air and water flow rates for both the Proposed Design and the Standard Design. This is to ensure that the systems in both design simulations are properly sized, which avoids the problem of differing part-load performance characteristics between the two designs.

Modeling Exceptions

All the energy systems of the Proposed Design must be modeled. The Standard Design, however, does have some exceptions that may be applied only in rare, special cases. It is allowable to exclude some components or systems of the Proposed Design provided they do not affect the energy usage of the other systems being modeled for trade-off purposes. For example, if the service hot water heating system is not located in the conditioned space, and if it is not generating significant heat gains that affect the HVAC system, then it may be ignored in the model. All systems that are excluded on this basis, however, must still meet the prescriptive requirements that apply to them. This exception can help to simplify the modeling somewhat, but only in ways that will not affect the accuracy of the WBP method calculations.

Limitations of the Simulation Program

There may also be cases where the simulation program lacks modeling capabilities needed to fully model a component or system of the

Proposed Design. If this means that a reasonable calculation of the proposed building cannot be made, then the best solution is to seek a different program that has the needed capabilities.

One alternative is to ignore the system in the model, provided this does not affect the modeling of energy consumption measures, described in the previous section. A second alternative is to apply engineering judgment and to model the component or system using a thermodynamically similar model that is within the capabilities of the program being used. This requires a thorough understanding of the algorithms of the simulation program and the thermodynamic characteristics of the component being modeled, but in many cases, it can be accomplished without compromising accuracy. It makes little sense, though, to use an alternate program for a component if it means losing the interactive capabilities of the hourly modeling tool. Consequently, this is generally not recommended.

A third alternative is to simply model the system or component as if it were the base case system defined for the Standard Design. Of course, this alternative is only allowable when the system or component meets the prescriptive requirements of the ECBC. Also, this alternative is not preferred, as the intent is to model the actual Proposed Design. The general rule, therefore, is if a simulation program can't model a component, then the component must not be given any energy saving benefits.

9.3.2 Climate Data

The simulation program shall use hourly values of climatic data, such as temperature and humidity, from representative climatic data for the city in which the Proposed Design is to be located. For cities or urban regions with several climate data entries, and for locations where weather data are not available, the designer shall

select available weather data that best represent the climate at the construction site.

9.3.3 Compliance Calculations

The Proposed Design and Standard Design shall be calculated using the following:

- a) Same simulation program,
- b) Same weather data, and
- c) Identical building operation assumptions (thermostat set points, schedules, equipment and occupant loads, etc.) unless an exception is allowed by this Code or the authority having jurisdiction for a given category.

Exceptional Calculation Method

As newer technologies become available, there may be cases where none of the existing simulation programs can adequately model the energy performance of these technologies. The WBP Method allows users to use exceptional calculations, provided the nature of the exceptional method is open-ended; however, the burden is on the applicant to demonstrate that the method is reasonable, accurate, well founded, and not in contradiction with the rules of the WBP Method. The applicant must describe the theoretical basis for the exceptional method and must provide empirical evidence that the method accurately represents the energy performance of the design, material, or device. The decision to accept or reject the proposed exceptional calculation method will ultimately lie with the authority having jurisdiction. From time to time, the technical committee BEE will compile and release a list of approved exceptional calculation methods.

Intent and Limitations of WBP Method

It is important for users of the WBP Method, as well as the owners of the proposed buildings, to understand the intent and limitations of the WBP

Method. It is intended to provide a fair method of comparison between the estimated annual energy consumption of the Proposed Design and the Standard Design for purposes of compliance with the Code. The WBP Method is not intended to provide the most accurate prediction of actual energy consumption for the building as it is actually built. Although the designer is expected to model the future use of the building as closely as possible, there are many reasons why the actual building performance may differ from the design energy consumption. These include:

- **Variations in Operation and Occupancy:** The actual schedules of operation and occupancy may differ from those assumed in the WBP analysis.
- **Variations in Control and Maintenance:** The building's energy systems may be controlled differently than assumed; the equipment may not be set up or maintained properly.
- **Variations in Weather:** The simulation runs use weather data that may not match the actual weather conditions; further, there is variability in weather conditions from year-to-year.
- **Energy Uses not Included:** The WBP method under certain conditions, may not require all building energy uses to be included in calculating the design energy consumption. Sometimes, there is additional energy-using equipment that is added to a building after it is built.
- **Precision of the Simulation Program:** Even the most sophisticated simulation programs approximate the actual energy flows and consumption in a building; further, the energy analyst will usually make simplifying assumptions. Both can be sources of error in the predictions of energy consumption.

9.4 Calculating Energy Consumption of Proposed Design and Standard Design

9.4.1 Energy Simulation Model

The simulation model for calculating the Proposed Design and the Standard Design shall be developed in accordance with the requirements in **Error! Reference source not found.** The Standard Design is based on the mandatory and prescriptive requirements of the ECBC compliant building. The Standard Design will be the same for all compliance levels (ECBC, ECBC+, Super ECBC).

9.4.2 HVAC Systems

The HVAC system type and related performance parameters for the Standard Design shall be determined from Table 9-2 and the following rules:

- a) Other components: Components and parameters not listed in Table 9-2 or otherwise specifically addressed in this subsection shall be identical to those in the Proposed Design.
- b) Exception to §0(a): Where there are specific requirements in §5.2.2, the component efficiency in the Standard Design shall be adjusted to the lowest efficiency level allowed by the requirement for that component type.
- c) All HVAC and service water heating equipment in the Standard Design shall be modeled at the minimum efficiency levels, both part load and full load, in accordance with §5.2.2.
- d) Where efficiency ratings, such as EER and COP, include fan energy, the descriptor shall be broken down into its components so that supply fan energy can be modeled separately.
- e) Minimum outdoor air ventilation rates shall be the same for both the Standard Design and the Proposed Design except for conditions specified in §9.4.2.1.
- f) The equipment capacities for the Standard Design shall be sized proportionally to the capacities in the Proposed Design based on sizing runs; i.e., the ratio between the capacities used in the annual simulations and the capacities determined by the sizing runs shall be the same for both the Proposed Design and Standard Design.
- g) Unmet load hours for the Proposed Design shall not differ from unmet load hours for the Standard Design by more than 50 hours. Maximum number of unmet hours shall not exceed 300 for either case.

Table 9-1 Modelling Requirements for Calculating Proposed and Standard Design

Case	Proposed Design	Standard Design
<p>1. Design Model</p>	<p>(a) The simulation model of the Proposed Design shall be consistent with the design documents, including proper accounting of fenestration and opaque envelope types and area; interior lighting power and controls; HVAC system types, sizes, and controls; and service water heating systems and controls.</p> <p>(b) When the whole building performance method is applied to buildings in which energy-related features have not been designed yet (e.g., a lighting system), those yet-to-be-designed features shall be described in the Proposed Design so that they minimally comply with applicable mandatory and prescriptive requirements of §Error! Reference source not found., §Error! Reference source not found., §Error! Reference source not found., and §Error! Reference source not found. and §Error! Reference source not found., §5.3, and §Error! Reference source not found. respectively.</p>	<p>The Standard Design shall be developed by modifying the Proposed Design as described in this table. Unless specified in this table, all building systems and equipment shall be modeled identically in the Standard Design and Proposed Design.</p>
<p>2. Space Use Classification</p>	<p>The building type or space type classifications shall be chosen in accordance with §2.5. More than one building type category may be used in a building if it is a mixed-use facility.</p>	<p>Same as Proposed Design.</p>
<p>3. Schedules</p>	<p>Operational schedules (hourly variations in occupancy, lighting power, equipment power, HVAC equipment operation, etc.) suitable for the building and/or space type shall be modeled for showing compliance. Schedules must be modeled as per §9.6. In case a schedule for an occupancy type is missing in §9.6, appropriate schedule may be used. Temperature and humidity schedules and set points shall be identical in the Standard and Proposed Designs. Temperature control/thermostat throttling ranges shall also be modeled identically in both the Designs.</p>	<p>Same as Proposed Design. Exception: Schedules may be allowed to differ between the Standard and Proposed models wherever it is necessary to model nonstandard efficiency measures and/or measures which can be best approximated by a change in schedule. Measures that may warrant a change in operating schedules include but are not limited to automatic controls for lighting, natural ventilation, demand controlled ventilation systems, controls for service water heating load reduction. Schedule change is not allowed for manual controls under any category. This is subject to approval by the authority having jurisdiction.</p>

4. Building Envelope

All components of the building envelope in the Proposed Design shall be modeled as shown on architectural drawings or as installed for existing building envelopes. Exceptions: The following building elements are permitted to differ from architectural drawings.

(a) Any envelope assembly that covers less than 5% of the total area of that assembly type (e.g., exterior walls) need not be separately described. If not separately described, the area of an envelope assembly must be added to the area of the adjacent assembly of that same type.

(b) Exterior surfaces whose azimuth orientation and tilt differ by no more than 45 degrees and are otherwise the same may be described as either a single surface or by using multipliers.

(c) For exterior roofs, other than roofs with ventilated attics, the reflectance and emittance of the roof surface shall be modeled in accordance with §4.3.1.1.

(d) Manually operated fenestration shading devices such as blinds or shades shall not be modeled. Permanent shading devices such as fins, overhangs, and light shelves shall be modeled.

(e) The exterior roof surface shall be modeled using the solar reflectance in accordance with ASTM E903-96 and thermal emittance determined in accordance with ASTM E408-71. Where cool roof is proposed, emittance and reflectance shall be modeled as per ASTM E408-71 and ASTM E903-96 respectively. Where cool roof is not proposed, the exterior roof surface shall be modeled with a reflectance of 0.3 and a thermal emittance of 0.9.

The Standard Design shall have identical conditioned floor area and identical exterior dimensions and orientations as the Proposed Design, except as noted in (a), (b), (c), and (d) below.

(a) Orientation. The Standard Design performance shall be generated by simulating the building with its actual orientation and again after rotating the entire building 90, 180, 270 degrees, then averaging the results. The building shall be modeled so that it does not shade itself.

(b) Opaque assemblies such as roof, floors, doors, and walls shall be modeled as having the same heat capacity as the Proposed Design but with the maximum U-factor allowed in §4.3.1 and §4.3.1.1. **Error! Reference source not found.**

(c) Fenestration. Fenestration areas shall equal that in the Proposed Design or 40% of gross above grade wall area, whichever is smaller, and shall be distributed on each face in the same proportions as in the Proposed Design. No shading projections are to be modeled; fenestration shall be assumed to be flush with the exterior wall or roof. Manually operated fenestration shading devices such as blinds or shades shall not be modeled. Fenestration U-factor shall be the maximum allowed for the climate, and the solar heat gain coefficient shall be the maximum allowed for the climate and orientation.

(d) Roof Solar Reflectance and Thermal Emittance: The exterior roof surfaces shall be modeled using a solar reflectance of 0.6 and a thermal emittance of 0.9.

5. Lighting

Lighting power in the Proposed Design shall be determined as follows:

Where a complete lighting system exists, the actual lighting power shall be used in the model.

Where a lighting system has been designed, lighting power shall be determined in accordance with §6.3.4.

Where no lighting exists, or is specified, lighting power shall be determined in accordance with the §6.3.2. **Error! Reference s**

Lighting power in the Standard Design shall be determined using the same categorization procedure (building area or space function) and categories as the Proposed Design with lighting power set equal to the maximum allowed for the corresponding method and category in either §6.3.2. **Error! Reference source not found.** or §6.3.3. Power for fixtures not included in the lighting power density calculation shall be modeled identically in the Proposed Design and Standard

source not found. or §6.3.3 for the appropriate building type.

Lighting system power shall include all lighting system components shown or provided for on plans (including lamps, ballasts, task fixtures, and furniture-mounted fixtures).

Lighting power for parking garages and building facades shall be modeled.

Minimum Lighting controls, as per the ECBC requirements of §6.2.1, shall be modeled in the Proposed case.

Automatic daylighting controls shall be modeled directly in the software or through schedule adjustments determined by a separate daylight analysis approved by the authority having jurisdiction.

Other automatic lighting controls shall be modeled directly in the software by adjusting the lighting power as per Table 9-4.

Design. Lighting controls shall be as per the ECBC requirements of §6.2.1.

HVAC Zones Designed: Where HVAC zones are defined on design drawings, each HVAC zone shall be modeled as a separate thermal block.

Same as Proposed Design

Exception: Identical zones (similar occupancy and usage, similar internal loads, similar set points and type of HVAC system, glazed exterior walls face the same orientation or vary by less than 45°) may be combined for simplicity.

HVAC Zones Not Designed: Where HVAC zones are not defined on design drawings, HVAC zones shall be defined based on similar occupancy and usage, similar internal loads, similar set points and type of HVAC system, glazed exterior walls that face the same orientation or vary by less than 45° in combination with the following rules:

Perimeter Core Zoning: Separate thermal block shall be modeled for perimeter and core spaces. Perimeter spaces are defined as spaces located within 5 meters of an exterior or semi exterior wall. Core spaces are defined as spaces located greater than 5 meters of an exterior or semi exterior wall. Separate thermal blocks shall be modeled for floors in contact with ground and for floors which have a ceiling/roof exposure to the ambient.

6.

HVAC Thermal Zones

7.
HVAC Systems

The HVAC system type and all related performance parameters, such as equipment capacities and efficiencies, in the Proposed Design shall be determined as follows:

(a) Where a complete HVAC system exists, the model shall reflect the actual system type using actual component capacities and efficiencies.

(b) Where an HVAC system has been designed, the HVAC model shall be consistent with design documents.

Mechanical equipment efficiencies shall be adjusted from actual design conditions to the rating conditions specified in §5, if required by the simulation model.

(c) Where no heating system has been specified, the heating system shall be assumed to be electric. The system characteristics shall be identical to the system modeled in the Standard Design.

(d) Where no cooling system has been specified, the cooling system and its characteristics shall be identical to the system modeled in the Standard Design.

The HVAC system type shall be as per Table 9-2 and related performance parameters for the Standard Design shall be determined from requirements of §9.4.2. Equipment performance shall meet the requirements of §5 for code compliant building.

8.
Service Hot Water

The service hot water system type and all related performance parameters, such as equipment capacities and efficiencies, in the Proposed Design shall be determined as follows:

(a) Where a complete service hot water system exists, the model shall reflect the actual system type using actual component capacities and efficiencies.

(b) Where a service hot water system has been designed, the service hot water model shall be consistent with design documents.

(c) Where no service hot water system exists, or is specified, no service hot water heating shall be modeled.

The service water heating system shall be of the same type as the Proposed Design.

For residential facilities, hotels and hospitals the Standard Design shall have a solar hot water system capable of meeting 20% of the hot water demand. Systems shall meet the efficiency requirements of §5.2.7.2, the pipe insulation requirements of §5.2.7.4 and incorporate heat traps in accordance with §5.2.7.5.

9.
Miscellaneous Loads

Receptacle, motor, and process loads shall be modeled and estimated based on the building type or space type category. These loads shall be included in simulations of the building and shall be included when calculating the Standard Design and Proposed Design. All end-use load components within and associated with the building shall be modeled, unless specifically excluded by this Table, but not limited to, exhaust fans, parking garage ventilation fans, exterior building lighting, swimming pool heaters and pumps, elevators and

Receptacle, motor and process loads shall be modeled the same as the Proposed Design.

escalators, refrigeration equipment, and cooking equipment.

10.
*Modelling
Limitations to
the Simulation
Program*

If the simulation program cannot model a component or system included in the Proposed Design, one of the following methods shall be used with the approval of the authority having jurisdiction:

Same as Proposed Design.

one of the following methods shall be used with the approval of the authority having jurisdiction:

(a) Ignore the component if the energy impact on the trade-offs being considered is not significant.

(b) Model the component substituting a thermodynamically similar component model.

(c) Model the HVAC system components or systems using the HVAC system of the Standard Design in accordance with Section 6 of this table.

Whichever method is selected, the component shall be modeled identically for both the Proposed Design and Standard Design models.

DRAFT

Table 9-2 HVAC Systems Map for Standard Design

	<i>Hotel/Motel, Hospital Patient Rooms, Hotel Guest Rooms, Resorts, Villas, Sleeping Quarters in Mixed-use Buildings, Schools, Classrooms/Lecture Rooms1</i>	<i>Buildings with Less than or Equal to 12,500 m² of Conditioned Area</i>	<i>Buildings with More than 12,500 m² of Conditioned Area</i>	<i>Data Centre/ Server/Computer Rooms</i>
Name	System A	System B	System C	System D
System Type2	<i>Split AC</i>	<i>VRF : Variable Refrigerant Flow</i>	<i>VAV: Central cooling plant with variable volume AHU for each zone</i>	<i>Computer Room air conditioners</i>
Fan Control	<i>Constant Volume</i>	<i>Constant volume</i>	<i>Variable volume</i>	<i>Constant volume</i>
Cooling Type	<i>Direct expansion with air cooled condenser</i>	<i>Direct expansion with air cooled condenser</i>	<i>Chilled Water with water cooled condenser</i>	<i>Direct expansion with air cooled condenser</i>
Heating Type	<i>1. Heat Pump: Where no heating system has been specified or where an electric heating system has been specified in the Proposed Design 2. Fossil Fuel Boiler: Where a heating system exists and a fossil fuel hot water boiler has been specified in the Proposed Design</i>	<i>1. Heat Pump: Where no heating system has been specified or where an electric heating system has been specified in the Proposed Design 2. Fossil Fuel Boiler: Where a heating system exists and a fossil fuel hot water boiler has been specified in the Proposed Design</i>	<i>1. Electric resistance: Where no heating system has been specified or where an electric heating system has been specified in the Proposed Design 2. Fossil Fuel Boiler: Where a heating system exists and a fossil fuel hot water boiler has been specified in the Proposed Design</i>	<i>NA</i>

Notes:

- Buildings of the listed occupancy types or spaces in Mixed-use Buildings with the listed occupancy types.*
 - Where attributes make a building eligible for more than one system type; use the predominant condition to determine the Standard Design system type provided the non-predominant conditions apply to less than 1,000 m² of conditioned floor area. Use additional system type for non-predominant conditions if those conditions apply to more than 1,000 m² of conditioned floor area.*
- Use additional system type for any space which has a substantial difference in peak loads and/or operational hours compared to the predominant space type. Such spaces may include but are not limited to computer/server rooms, retail areas in residential, or office buildings.*

Design Model

The Proposed Design and the corresponding Standard Design shall be consistent with information contained on the plans and

specifications. Some buildings, such as retail malls and speculative office buildings typically are built in phases. For example, the core mechanical system may be installed with the base building, while the ductwork and terminal

units are installed later as part of tenant improvements.

For the purpose of calculating the Proposed Building, the rule is simple: the features that are not yet designed or documented in the construction documents are assumed to minimally comply with the applicable prescriptive requirements of the ECBC, as specified in Sections 4 through 8. In cases where the space use classification is not known, the default assumption is to classify it as office space using the Building Area Method.

The WBP Method is based on the assumption that non-residential buildings are both heated and cooled. Even if not installed initially, it is common for buildings lacking a heating or cooling system to have one retrofitted by future occupants. Accordingly, there is a special rule for calculating energy use in the Proposed Design when a building's HVAC system is heating-only or cooling-only: the building must be modeled as if it is going to have both heating and cooling. The missing system is modeled as the default heating or cooling system that just meets the prescriptive requirements of the ECBC. The same system is modeled for both Standard and Proposed Designs.

Space Use Classifications

A key task in modeling the Proposed Design is assigning space use classifications to different areas of the building. These classifications are used to assign lighting power density assumptions and to differentiate areas within the building that may have different operating schedules and characteristics (thermostat settings, ventilation rates, etc.). The choice of space use classifications is taken from one of the two lighting tables in the ECBC: either Table 6-1 Interior Lighting Power for ECBC Buildings – Building Area Method or Table 6-4 Interior Lighting Power for ECBC Buildings – Space Function Method. The designer may choose

either classification scheme but may not mix the schemes by using one for part of the building and the other for the rest of the building. “Building,” in this context, refers to the space encompassed by a single building permit application, which may be less than the complete building.

The secondary support areas associated with each of the major building types would be included in each building type. For example, if a building included both office and retail areas, the corridors and restrooms associated with the office occupancy would be included in the office area and the storage or/and dressing room areas associated with the sales floor would be included in the retail area.

Schedules

Schedules are used to describe the percentage of a maximum design value of an internal load that is applicable during a particular time period, usually one hour, i.e., lighting power density, miscellaneous equipment (plug load) power density, occupant load or any other significant load thermostat set point (s) applicable in this time period, or the availability (on/off), and control operation of a system or system component, e.g., cooling systems, fans, chillers, or pumps. Schedules have a large impact on the overall energy consumption. Designers are required to specify Weekday, Saturday, Sunday, and Holiday operation in each schedule. An example for Weekday schedules in an office building is shown below.

The ECBC allows designers to select reasonable or typical schedules for the building. In all cases, the schedules for the Proposed Design and the Standard Design shall be identical. This means that the Proposed Design may not take advantage of scheduling changes. It further means that any equipment in the Proposed Design that saves energy by altering operating patterns or profiles must be modeled explicitly; it is not sufficient simply to assume a schedule

change and use that to account for the electricity savings.

An example is daylighting controls, which reduce lighting power when daylight is available in a space. The Proposed Design must simulate the actual performance of the daylighting control in response to daylight availability, rather than the simulator simply assuming some schedule change that arbitrarily reduces lighting power during daylight hours. Another example of equipment that must not be modeled by reducing operating hours in the Proposed Design are occupancy-sensing controls that turn off equipment when not needed. While this type of equipment might well be installed because of the owner's conviction that it is a good investment, there is no credit for it under the WBP method.

In selecting the schedules, it is prudent to consider the likely long-term operation of the building. For example, if a new school will initially operate on a traditional schedule, but the school district has a policy of shifting its schools over to year-round operation, then it would be prudent to apply a year-round schedule in the WBP method modeling. The selected schedules should likewise not intentionally misrepresent the operation of the building. If a grocery store chain keeps its stores open 24 hours a day, it would be inappropriate to use a 12-hour-a-day operating schedule in the modeling.

Building Envelope

The building footprint and overall geometry must be identical for both the Standard and Proposed Designs, and must use the design shown on the final architectural drawings, including building shape, dimensions, surface orientations, opaque construction assemblies, glazing assemblies, etc. That is, they must have the identical plan, conditioned floor area, number of floors, floor-to-floor distances, wall and roof areas, surface tilts and orientation.

In some cases, the building envelope may already exist, as in the case of newly conditioned space or a tenant build-out of a shell building; in these cases, the existing building envelope is modeled.

The Standard Design will have the maximum allowable window-to-wall-ratio (WWR) in each orientation, but the Proposed Design may exceed this limit, provided compliance is achieved. Opaque assemblies like walls, roofs and floors must be described by material layer as per the architectural drawings. For the Standard Design, the characteristics (U-factor) of these envelope components are set to the prescriptive values specified in ECBC §4.3.

The heat capacities for each assembly type must match the heat capacities of the Proposed Design. This is because heat capacities may have a significant effect on the performance of envelope components, which shows up in the simulation runs but they are not a requirement of the ECBC. Heat capacity is modeled to be the same in both the Proposed Design and the Standard Design simulation runs, and so is energy neutral under the WBP method.

For the Standard Design, exterior roof surfaces, other than those with ventilated attics, must be modeled assuming a surface reflectance value of 0.6. If a Proposed Design calls for a reflective roof surface, however, the model may assume a long-term average reflectance of 0.45, which results in the lower heat absorption of the reflective surface and makes a conservative allowance for degradation of the reflectivity over its lifetime. For this exception to be allowed, the specified reflectance of the roof in the Proposed Design must exceed 0.70 and its emittance must exceed 0.75. (As per ASHRAE 90.1, 2004)

Windows / Fenestration

The solar, thermal, and optical performance of windows systems are defined by the combination of four main parameters, i.e., the area as defined by the window-to-wall ratio,

thermal transmittance (U-factor), Solar Heat Gain Coefficient (SHGC), and Visible Light Transmission (VLT).

Fenestration Area

Fenestration areas and performance are strong drivers of energy use in buildings. Therefore, the ECBC places great emphasis in how these values are calculated and applied for compliance.

ECBC §4.3.3 and §4.3.4 sets the prescriptive upper limits on vertical fenestration area and skylight area. If the fenestration areas for the Proposed Design are less than these limits, the Standard Design shall have the same areas and orientations as the Proposed Design.

If the fenestration areas in the Proposed Design exceed these limits, then the corresponding areas in the Standard Design must be adjusted down to these limits and corresponding increases made to opaque areas so that the gross wall area is no longer the same for the Proposed Design and the Standard Design.

The prescriptive envelope requirements of the Code do not provide an exception for street-level, street-side vertical fenestration (e.g., store display windows). Thus, such fenestration must be modeled identically for the Proposed Design and the Standard Design simulation runs so that the representation of these types of fenestration is energy neutral.

U-Factors

The U-factor for the Standard Design is set to the minimum required for the climate, as specified in ECBC Table 4-10. The minimum U-factor is a function of the percentage of glazing (WWR) in a wall or roof, as described above.

Solar Heat Gain Coefficient

The solar heat gain coefficient value for the fenestration applied in the Standard Design is set to the maximum required for the climate and for

each orientation, as specified in ECBC Table 4-10. The maximum SHGC is a function of the glazing percentage of wall or roof, which is based on the Proposed Design as described above.

If the vertical fenestration to be used is unrated, then the SHGC values in ECBC Table 10-1 must be used.

Shading of Fenestration

Glazing installed in the Standard Design must be modeled as being flush with its wall or roof surface, and without any external shading devices. This ruling allows the Proposed Design to use to its advantage shading from window recesses, overhangs, side fins, or other permanent shading devices that reduce solar gains on the glazing.

Interior shading devices, if not automatic, should not be modeled in the Proposed Design. In Standard Design, no shading should be modeled.

Exceptions for Envelope

Any simulation program necessarily relies on a somewhat simplified description of the building envelope. It is usually time-consuming and difficult to explicitly detail every minor variation in the envelope design, and if good engineering judgment is applied, these simplifications won't result in a significant decline in accuracy. Three exceptions, where more substantial simplifications may be made, are:

Minor Assemblies:

Frequently, there will be small areas on the building envelope with unique thermal characteristics. The ECBC exempts any envelope assembly that covers less than 5% of the total area of a given assembly type (e.g., exterior walls or roofs) from being treated as a separate envelope component. Instead, that area may be added to an adjacent assembly of the same type. For example, if there is an exterior wall constructed of load-bearing masonry, but there

are small wood-framed infill areas, the infill areas may be treated as if the entire wall is of masonry. Note that the gross wall area is unchanged, and no areas are left out of the model.

Different Tilt or Azimuth

This exception, primarily intended to address curved surfaces, specifies the minimum number of orientations into which these surfaces must be split up. The Standard allows similarly oriented surfaces to be grouped under a single tilt or azimuth, provided they are of similar construction and provided the tilt or azimuth of the surfaces are within 45 degree of each other. They may be grouped as a single surface or a multiplier may be used.

Fenestration: Interior and/or exterior shading devices in the Proposed Design shall not be modeled unless they are automatically controlled. In the Standard Design, shades of any kind are not modeled. When the window area in the Proposed Design exceeds the prescriptive maximum, the window area in the Standard Design is set to the prescriptive maximum area and representative opaque wall area replaces any excess window area. Thus the overall wall area (opaque wall + window area) is the same for both standard and proposed buildings. The window area in Standard Design is decreased uniformly in each orientation so that the fraction of total window area in each direction is the same in both Standard Design and Proposed Design simulation models.

Lighting Systems

Under the WBP method, lighting systems are a very important part of overall building performance for most non-residential building types. Any lighting system efficiency improvements or reductions are reflected as energy savings in the WBP method. The description of lighting systems in building energy simulation models must incorporate the following two characteristics:

- Application of a lighting power density (LPD) for each space or thermal zone of the building model. This may be determined using one of the two methods defined in §6.3.2 (building area method) or §6.3.3 (space function method).
- An operational schedule for the lighting system which describes the percentage of the maximum LPD value that is energized during a particular hour.

There are further requirements if the electric lighting system is to be controlled in response to the amount of daylight in perimeter zones of the building. In such cases, the building simulation program must be able to explicitly model daylight levels in each perimeter space that has daylight linking. Light sensors must be modeled in these zones, and a control strategy must be applied that modulates electrical energy output from the electric lighting system. Typically there are at least three daylight linked control schemes to modulate electrical energy output:

- **Stepped control:** in this control scheme, the electrical lighting system can respond to the presence of daylight in defined steps
- **Linear control:** the lighting system modulates it's output in a linear function to a prescribed minimum level, and
- **Linear/off:** the lighting system modulates it's output in a linear function and will switch off (use zero electrical energy) when there is sufficient daylight in the space

Either the building area or space function method may be used, but the categorization of spaces must be identical between the Standard Design and the Proposed Design.

The LPD for the Proposed Design is taken from the design documents for the building. If a lighting system already exists, then the lighting system design for Proposed Design will be based on the actual lighting power density of the

existing system. In the special case where no lighting system or design exists, as in a shell building where the lighting will be installed by a future tenant, then a default lighting power density must be assumed, based on the building area method for the appropriate building type. If no building type is known, then an office building is assumed.

Exterior lighting systems as defined in ECBC §6.2.1.4 shall contain lamps having a minimum efficacy of 80 lm/W unless, the luminaire is controlled by a motion sensor or is an emergency lighting

HVAC

Incorporating HVAC systems into whole building energy simulation models is a complex process. It requires knowledge of how buildings respond to climate, in addition to knowledge of the configuration of HVAC systems and appropriate control strategies. For the purpose of building energy simulation it is useful to think of the building model as having three HVAC type components - ZONES, SYSTEMS and PLANT.

HVAC Zoning

A key task in developing both of the simulation models is to divide the Proposed Design into a series of spaces or “thermal zones” to be input to the energy simulation program. Due care and consideration needs to be taken to divide the building into an appropriate number of thermal zones. There are several considerations for this division, and some of these considerations can be conflicting. The following are some of the considerations that need to be thought through when dividing the building for simulation analysis.

Building areas that are thermodynamically similar spaces and whose heating and cooling loads can be satisfied through use of a single thermostat (or other type of temperature control) can be combined in a single thermal

zone. Since this requires mapping of the HVAC system design into the simulation model, the simulator needs to work interactively with the services consultant.

Building areas that perform a similar function in the building design may be combined to form a thermal zone – for example, some open plan office areas, or retail shop areas that have similar loads and operate similar hours may be combined. These areas would have identical schedules applied for operation of internal loads and HVAC systems.

Building areas that have the same lighting power density may be combined, i.e. the use of “space use classifications.” The choice of space use classifications is taken from one of the two lighting tables in the ECBC, either Table 7.1 (Interior Lighting Power-Building area method) or Table 7.2 (Interior Lighting Power-Space Function method). The designer may choose either classification scheme but may not mix the schemes by using one for part of the building and the other for the rest of the building.

“Building” in this context refers to the space encompassed by a single building permit application, which may be less than the complete building. The secondary support areas associated with each of the major building types would be included in each building type. For example, if a building included both office and retail areas, the corridors and restrooms associated with the office occupancy would be included in the office area and the storage or/and dressing room areas associated with the sales floor would be included in the retail area.

HVAC Zones are identical to the thermal zones or spaces discussed earlier. An HVAC designer will consider the internal and external loads on each zone to calculate a “design day” cooling and heating load, and the maximum outside air ventilation required. He or she may combine two or more thermal zones into a “thermal block”

designed to be conditioned by a single HVAC SYSTEM, for example, an Air Handling Unit (AHU) or an DX system. If the building uses central air-conditioning systems (as opposed to DX systems, see Chapter 5), then a series of HVAC SYSTEMS may be served by one or more HVAC PLANT component (chillers, pumps, cooling towers etc).

For the WBP Method using building energy simulation analysis, HVAC ZONES must be described to be identical in both the Standard Design and the Proposed Design Models. This rule ensures consistency with the requirement that the shape and area of the building envelope for the Standard Design be the same as for the Proposed Design, and that the space use classifications be the same.

HVAC Zoning Based On HVAC Design

As noted earlier, building areas that are thermodynamically similar spaces and whose heating and cooling loads can be satisfied through use of a single thermostat (or other type of temperature control) can be combined in a single thermal zone. The outside air flow quantities, and control strategies applicable to the duct outlets or other terminal units controlled by this single thermostats may be part of the HVAC ZONE description. Clearly, this process requires mapping of the HVAC SYSTEM design into the simulation model, and the simulator needs to work interactively with the services consultant.

Use of HVAC Zone Multiplier

In some simulation programs, the interior HVAC ZONES of a multi-story building, which may be physically separate zones on each floor can be reasonably combined and treated as a single thermal zone with a multiplier. Use of a multiplier allows simplification of the calculation of electricity consumption for the whole building without having to repeatedly describe many similar or identical zones in the simulation model, thus saving time and effort without

significant loss of accuracy. However, a cafeteria or computer room in an office building would need to be modeled separately, as would lower-floor retail uses.

The following conditions must be met to be able to use the multiplier option:

- All of the space use classifications must be the same throughout the thermal zone. This ensures that they have the same load and schedule characteristics.
- For exterior (or perimeter) HVAC ZONES with glazing, the glazing for all zones included in the thermal block must have the same orientation or at least their orientations must be within 45 degrees of each other. This ensures that they have the same solar heat gain characteristics. This is not to say that the zones may not have two or more glazing orientations – a corner office could easily have two – but that the zones must have similar orientations. It would be acceptable, for example, to group all of the northeast corner offices on the intermediate floors of an office tower into a single thermal block.
- All of the HVAC ZONES in different floors must be served either by the same HVAC SYSTEM or by the same kind of HVAC SYSTEM. This is so that the simulation program can accurately model the performance of the system (s) serving the zones.

HVAC Zoning When No HVAC Design Exists

In a situation where an HVAC ZONING plan has not been designed, then a configuration of thermal blocks must be assumed for the WBP method. This situation is quite common in commercial buildings where the future tenants will determine the zoning of spaces in the building. In this case, the building must be divided into thermal zones based on similar internal load densities and lighting power

densities, operational schedules, occupancy patterns, space temperature schedules, etc. There are several guidelines that should be followed in this situation, as described below.

Zoning Based on Perimeter and Interior Spaces

In situations when no HVAC design has been developed, divide the floor plate into perimeter spaces than are within 5 meters of an exterior wall, and interior spaces that are more than 5 meters from an exterior wall.

Zoning Based on Glazing Orientation

Glazed exterior walls should be assigned to different perimeter thermal zones for each major orientation. Orientations within 45 degrees of each other may be combined. Spaces with two or more glazed orientations, such as corner offices, should be divided proportionately between zones having the different orientations.

Zoning Based on Floor Levels

Spaces exposed to ambient conditions, such as the top floor or an overhanging floor, and spaces in contact with the ground, such as the ground floor, must be zoned separately from zones that are not exposed to ambient conditions, such as intermediate floors in a multi-story building. Therefore, a multi-storey tower office building could be divided into a top floor, a typical middle floor with the appropriate floor multiplier, and a bottom floor.

HVAC Systems

Defining HVAC systems for use with whole building simulation programs is complex, and there are many interrelated rules. Some of the rules that govern the description of HVAC SYSTEMS for the ECBC whole building performance method are:

- The HVAC System described in the Standard Design should just meet the prescriptive requirements of the ECBC. These requirements are deemed representative of

current standard practice that meets the ECBC.

- Where possible, the HVAC System is to be conceptualized as completely as possible on the actual system designed for the Proposed Design. This includes the system type, equipment capacities and efficiencies, controls, ancillary features (such as economizers), etc. The equipment efficiencies may need to be adjusted to meet the needs of the simulation program. While efficiencies may be most accurately specified at the building's design conditions, most simulation programs require efficiencies to be specified at standard rating conditions, such as those given in ECBC §5.2.2.
- Where the entire HVAC System design is not known, as in the case of a shell-and-core design, the unknown parts of the system are assumed to just meet the prescriptive requirements of the ECBC and to be energy neutral. This strategy prevents gamesmanship with the undefined system components. Gamesmanship is the practice of artificially reducing the efficiency of the Standard Design in order to increase the apparent relative efficiency of the Proposed Design4.
- Where the complete HVAC System exists, the Proposed Design and Standard Design are based on the existing HVAC system – for example, fit out of an existing speculative building for a tenant. The subject of the building permit is primarily the interior construction and lighting system and does not include the HVAC system because it has already been built and permitted. Both simulation models would also include the existing building envelope.
- Where no heating system exists, a default heating system must be assumed and modeled. It should be a simple heating system that burns fossil fuel, sized with sufficient capacity to meet the design

heating loads for the Proposed Design. An identical system (with sizing adjustments) must be assumed for the Standard Design.

The WBP Method is more vulnerable to this sort of misuse, which is why the rules for constructing the Standard Design must be so specific. The WBP modeling rules for part-load efficiency and system sizing are intended to minimize these effects on the trade-off calculations for the other measures in the building. For example, electricity consumption differences cannot be gained for a difference between a properly sized HVAC system in the Proposed Design and an improperly sized HVAC system for the Standard Design. The modeling rules are discussed individually in the following sections:

- Where no cooling system exists, a default cooling system must be assumed and modeled for both the Standard Design and Proposed Design.

Minimum Efficiencies

The minimum efficiencies for HVAC equipment (§5.2.2) and for service hot water heating equipment (§5.2.7) must be used for the applicable equipment in the Standard Design. This includes any part-load efficiencies, if these are specified. These efficiency requirements set the baseline for equipment trade-offs under the WBP method. The actual equipment efficiency of the Proposed Design is then used to calculate the Standard Design.

Since mechanical and service hot-water heating equipment efficiency is a prescriptive requirement, if the equipment is covered by these equipment requirements, the equipment efficiency in the Proposed Design must be equal to or greater than the prescriptive equipment efficiency. If mechanical or service hot water heating equipment falls outside of those listed in the efficiency tables, the standard equipment efficiency shall be equal to the efficiency of the equipment in the Proposed Design. Thus the only

trade-off available for equipment efficiency is to specify higher efficiencies than those called for in the ECBC, which would give electricity consumption savings for the design.

9.4.2.1 Minimum Outdoor Air Rates:

Minimum outdoor air rates shall be identical for both the Standard Design and Proposed Design, except

- a) when modeling demand controlled ventilation (DCV) in the Proposed Design (DCV is not required in the Standard Design as per §5.2.1.3)
- b) when the Proposed Design has a minimum ventilation flow higher than the minimum required by the applicable code, the Standard Design shall be modeled as per the minimum ventilation rate required by the applicable code and the Proposed Design shall be modeled as per actual design (higher than Standard Design)

9.4.2.2 Fan Schedules

Supply and return fans shall operate continuously whenever the spaces are occupied and shall be cycled to meet heating and cooling loads during unoccupied hours.

9.4.2.3 Fan Power

- a) For Systems Types A, B and D,

$$P_{fan} = cmh \times .51$$

Where P_{fan} = Standard Design fan power in watts

cmh = Standard Design supply airflow rate auto-sized by the simulation software

- b) For System Type C

Fan power shall be modeled as per power and efficiency limits specified in

Table 5-11 using a static pressure of 622 Pa or the design static pressure, whichever is higher. The simulation software shall automatically calculate the Standard Design fan power based on the above inputs.

9.4.2.4 Design Airflow Rates

Design airflow rates for the Standard Design shall be sized based on a supply air to room air temperature difference of 11 °C. The Proposed Design airflow rates shall be as per design.

9.4.2.5 Economizers (airside and waterside)

Airside economizers shall be modeled in the Standard Design as per the requirements of §5.3.4.

Exception to §9.4.2.5: Airside economizer shall not be modeled for Standard Design HVAC System Type A.

Table 9-3 Modeling Requirements for Calculating Proposed and Standard Design

Peak Building Cooling Load (kW _r)	Chiller Type
< 1,055	1 Water Cooled Screw Chiller
1,055 to 2,110	2 Water Cooled Screw Chillers
> 2,110	2 Water Cooled Centrifugal Chillers minimum, equally sized such that no Chiller is greater than 2,813 kW _r

Exception to above: Air cooled chillers are allowed to be modeled in the Standard Design if the Proposed Design has air cooled chillers. If the proposed building has a mix of air and water cooled chillers, then the Standard Design shall be modeled with a mix of air and water cooled chillers in the same proportion as in the Proposed Design. However, this exception applies only for minimum ECBC compliance. Air cooled chillers shall not be modeled in the Standard Design when demonstrating compliance with ECBC+ and SuperECBC Building requirements.

9.4.2.9 Chilled Water Pumps

Chilled and condenser water pumps for the Standard Design shall be modeled as per power and efficiency limits specified in Table 5-16.

Standard Design chilled water pumps shall be modeled as primary-secondary with variable secondary flow.

9.4.2.6 Energy Recovery

Energy recovery shall be modeled in the Standard Design as per the requirements of §5.3.7.

9.4.2.7 Chilled Water Design Supply Temperatures

Chilled water design supply temperature shall be modeled at 6.7° C and return temperature at 13.3° C.

9.4.2.8 Chillers

Only electric chillers shall be modeled in the Standard Design for System C. Chillers shall meet the minimum efficiency requirements indicated in Table 5-1 and Table 5-2. Chillers in the Standard Design shall be selected as per Table 9-3 below:

9.4.2.10 Cooling Tower

Standard Design cooling tower shall be modeled as an open circuit axial flow tower with power and efficiency as per Table 5-19. The fans shall be modeled as two speed.

Condenser water design supply temperature shall be 29.4°C or 5.6°C approach to wet bulb

temperature, whichever is lower, with a design temperature rise of 5.6°C.

9.4.2.11 Boiler

Standard Design boilers shall be modeled as natural draft boilers and shall use the same fuel as the Proposed Design. Boiler efficiency shall be modeled as per **Error! Reference source not found.**

9.4.2.12 Hot Water Design Supply Temperatures

Hot water design supply temperature shall be modeled at 82°C and return temperature at 54°C.

9.4.2.13 Hot Water Pumps

The Standard Design hot water pumps shall be modeled with a minimum efficiency of 70% and a pump power of 300 W/l-s⁻¹.

Standard Design hot water pumps shall be modeled as primary-secondary with variable secondary flow.

9.4.2.14 Campus/District Cooling Systems

All district cooling plants shall be assumed to be on grid electricity, unless otherwise specified and supported through pertinent documents. New district plants shall comply with the mandatory requirements of ECBC irrespective of who owns and/or operates the district plant.

Projects may choose either option A or option B given below for modelling campus/district cooling systems.

Option A

The cooling source shall be modeled as purchased chilled water in both the Standard Design and Proposed Design. For the Standard Design, Table 9-2, shall be modified as follows:

- a) For System Type C; purchased chilled water shall be modeled as the cooling source.
- b) System Types A and B shall be replaced with a two-pipe fan coil system with purchased chilled water as the cooling source.

The chilled water/thermal energy consumption simulated by the software shall be converted to units of kWh and added to the overall building energy consumption. The following conversion factors shall be used to convert chilled water/thermal energy consumption to units of kWh.

$$1 \text{ ton hour} = 0.85 \text{ kWh}$$

$$1 \text{ MBtu} = 1,000,000 \text{ Btu} = 293 \text{ kWh}$$

Option B

The Standard Design shall be modeled as per Table 9-2 HVAC Systems Map for Standard Design.

For the Proposed Design, model a virtual onsite chilled water plant with Chiller, Pumps and cooling towers modeled at minimum efficiency levels as per §9.4.2.7 to §9.4.2.10. Airside/low side capacities shall be modeled as per design and the plant capacities shall be auto-sized by the software.

Table 9-4 Power Adjustment Factors for Automatic Lighting Controls

<i>Automatic Control Device</i>	<i>Daytime occupancy and area <300 m²</i>	<i>All Others</i>
<i>Programmable Timing Control</i>	10%	0%
<i>Occupancy Sensor</i>	10%	10%
<i>Occupancy Sensor and Programmable Timing Control</i>	15%	10%

9.4.3 Compliance Thresholds for ECBC compliant, ECBC+ and SuperECBC Buildings

For buildings to qualify as ECBC+ and SuperECBC Buildings, the WBP Method shall be followed for the Standard Design as detailed above. The

Proposed Design for ECBC+ and SuperECBC Buildings shall meet the mandatory provisions of §4.2, §5.2, §6.2 and §7.2.

The EPI Ratio for ECBC+ and SuperECBC Buildings shall be equal to or less than the EPI Ratios listed under the applicable climate zone in Table 9-5 through Table 9-9 of §9.5.

9.5 Maximum Allowed EPI Ratios

Table 9-5 Maximum Allowed EPI Ratios for Building in Composite Climate

<i>Building Type</i>	<i>Composite</i>		
	<i>ECBC</i>	<i>ECBC+</i>	<i>SuperECBC</i>
<i>Hotel (No Star and Star)</i>	1	0.91	0.81
<i>Resort</i>	1	0.88	0.76
<i>Hospital</i>	1	0.85	0.77
<i>Outpatient</i>	1	0.85	0.75
<i>Assembly</i>	1	0.86	0.77
<i>Office (Regular Use)</i>	1	0.86	0.78
<i>Office (24Hours)</i>	1	0.88	0.76
<i>Schools and University</i>	1	0.77	0.66
<i>Open Gallery Mall</i>	1	0.85	0.76
<i>Shopping Mall</i>	1	0.86	0.74
<i>Supermarket</i>	1	0.81	0.70
<i>Strip retail</i>	1	0.82	0.68

Table 9-6 Maximum Allowed EPI Ratios for Buildings in Hot and Dry Climate

<i>Building Type</i>	<i>Hot and Dry</i>		
	<i>ECBC</i>	<i>ECBC+</i>	<i>SuperECBC</i>
<i>Hotel (No Star and Star)</i>	<i>1</i>	<i>0.90</i>	<i>0.81</i>
<i>Resort</i>	<i>1</i>	<i>0.88</i>	<i>0.76</i>
<i>Hospital</i>	<i>1</i>	<i>0.84</i>	<i>0.76</i>
<i>Outpatient</i>	<i>1</i>	<i>0.85</i>	<i>0.75</i>
<i>Assembly</i>	<i>1</i>	<i>0.86</i>	<i>0.78</i>
<i>Office (Regular Use)</i>	<i>1</i>	<i>0.86</i>	<i>0.78</i>
<i>Office (24Hours)</i>	<i>1</i>	<i>0.88</i>	<i>0.76</i>
<i>Schools and University</i>	<i>1</i>	<i>0.77</i>	<i>0.66</i>
<i>Open Gallery Mall</i>	<i>1</i>	<i>0.85</i>	<i>0.77</i>
<i>Shopping Mall</i>	<i>1</i>	<i>0.84</i>	<i>0.72</i>
<i>Supermarket</i>	<i>1</i>	<i>0.73</i>	<i>0.69</i>
<i>Strip retail</i>	<i>1</i>	<i>0.82</i>	<i>0.68</i>

Table 9-7 Maximum Allowed EPI Ratios for Buildings in Temperate Climate

<i>Building Type</i>	<i>Temperate</i>		
	<i>ECBC</i>	<i>ECBC+</i>	<i>SuperECBC</i>
<i>Hotel (No Star and Star)</i>	<i>1</i>	<i>0.90</i>	<i>0.80</i>
<i>Resort</i>	<i>1</i>	<i>0.88</i>	<i>0.75</i>
<i>Hospital</i>	<i>1</i>	<i>0.82</i>	<i>0.73</i>
<i>Outpatient</i>	<i>1</i>	<i>0.85</i>	<i>0.75</i>
<i>Assembly</i>	<i>1</i>	<i>0.85</i>	<i>0.76</i>
<i>Office (Regular Use)</i>	<i>1</i>	<i>0.85</i>	<i>0.75</i>
<i>Office (24Hours)</i>	<i>1</i>	<i>0.87</i>	<i>0.74</i>
<i>Schools and University</i>	<i>1</i>	<i>0.77</i>	<i>0.66</i>
<i>Open Gallery Mall</i>	<i>1</i>	<i>0.83</i>	<i>0.74</i>
<i>Shopping Mall</i>	<i>1</i>	<i>0.84</i>	<i>0.71</i>
<i>Supermarket</i>	<i>1</i>	<i>0.81</i>	<i>0.69</i>
<i>Strip retail</i>	<i>1</i>	<i>0.81</i>	<i>0.67</i>

Table 9-8 Maximum Allowed EPI Ratios for Buildings in Warm and Humid Climate

Building Type	Warm and Humid		
	ECBC	ECBC+	SuperECBC
Hotel (No Star and Star)	1	0.91	0.81
Resort	1	0.88	0.75
Hospital	1	0.86	0.77
Outpatient	1	0.86	0.76
Assembly	1	0.88	0.80
Office (Regular Use)	1	0.86	0.76
Office (24Hours)	1	0.88	0.76
Schools and University	1	0.77	0.66
Open Gallery Mall	1	0.86	0.77
Shopping Mall	1	0.85	0.72
Supermarket	1	0.82	0.70
Strip retail	1	0.83	0.68

Table 9-9 Maximum Allowed EPI Ratios for Buildings in Cold Climate

Building Type	Cold		
	ECBC	ECBC+	SuperECBC
Hotel (No Star and Star)	1	0.91	0.82
Resort	1	0.88	0.75
Hospital	1	0.88	0.80
Outpatient	1	0.85	0.75
Assembly	1	0.87	0.81
Office (Regular Use)	1	0.88	0.80
Office (24Hours)	1	0.87	0.75
Schools and University	1	0.85	0.73
Open Gallery Mall	1	0.82	0.73
Shopping Mall	1	0.96	0.93
Supermarket	1	0.80	0.68
Strip retail	1	0.80	0.66

9.6 Schedules

Table 9 10 Schedules for Business Buildings

<i>Business</i>								
<i>Time Period</i>	<i>Occupancy Schedule</i>		<i>Lighting Schedule</i>		<i>Equipment Schedule</i>		<i>Elevator Schedule</i>	
	<i>Daytime Business</i>	<i>24 Hour Business</i>	<i>Daytime Business</i>	<i>24 Hour Business</i>	<i>Daytime Business</i>	<i>24 Hour Business</i>	<i>Daytime Business</i>	<i>24 Hour Business</i>
00:00-01:00	0.00	0.90	0.05	0.90	0.00	0.95	0.05	0.55
01:00-02:00	0.00	0.90	0.05	0.90	0.00	0.95	0.05	0.25
02:00-03:00	0.00	0.90	0.05	0.90	0.00	0.95	0.05	0.25
03:00-04:00	0.00	0.90	0.05	0.90	0.00	0.95	0.05	0.15
04:00-05:00	0.00	0.50	0.05	0.50	0.00	0.00	0.05	0.35
05:00-06:00	0.00	0.20	0.05	0.05	0.00	0.00	0.05	0.50
06:00-07:00	0.00	0.10	0.10	0.05	0.00	0.00	0.20	0.20
07:00-08:00	0.10	0.10	0.30	0.90	0.00	0.95	0.40	0.40
08:00-09:00	0.20	0.90	0.90	0.90	0.10	0.95	0.80	0.80
09:00-10:00	0.95	0.90	0.90	0.90	0.90	0.95	0.80	0.80
10:00-11:00	0.95	0.90	0.90	0.90	0.90	0.95	0.55	0.55
11:00-12:00	0.95	0.90	0.90	0.90	0.90	0.95	0.35	0.35
12:00-13:00	0.95	0.90	0.90	0.90	0.90	0.95	0.25	0.25
13:00-14:00	0.50	0.20	0.50	0.50	0.80	0.20	0.95	0.95
14:00-15:00	0.95	0.90	0.90	0.90	0.90	0.95	0.95	0.95
15:00-16:00	0.95	0.90	0.90	0.90	0.90	0.95	0.35	0.35
16:00-17:00	0.95	0.90	0.90	0.90	0.90	0.95	0.15	0.35
17:00-18:00	0.95	0.90	0.95	0.90	0.90	0.95	0.75	0.70
18:00-19:00	0.30	0.90	0.50	0.90	0.50	0.20	0.95	0.95
19:00-20:00	0.10	0.20	0.30	0.90	0.10	0.95	0.50	0.50
20:00-21:00	0.10	0.90	0.30	0.90	0.10	0.95	0.30	0.35
21:00-22:00	0.10	0.90	0.20	0.90	0.00	0.95	0.20	0.25
22:00-23:00	0.00	0.90	0.10	0.90	0.00	0.95	0.05	0.25
23:00-24:00	0.00	0.90	0.05	0.90	0.00	0.20	0.05	0.55

Table 9-10 Schedules for Assembly Buildings

Assembly								
Time Period	Occupancy Schedule	Lighting Schedule	Equipment Schedule	Elevator Schedule	Fan HVAC Schedule (On/Off)	External Lighting Schedule	Basement Ventilation	Basement Lighting
00:00-01:00	0.00	0.00	0.00	0.00	0	0.80	0.00	0.80
01:00-02:00	0.00	0.00	0.00	0.00	0	0.80	0.00	0.10
02:00-03:00	0.00	0.00	0.00	0.00	0	0.80	0.00	0.10
03:00-04:00	0.00	0.00	0.00	0.00	0	0.80	0.00	0.10
04:00-05:00	0.00	0.00	0.00	0.00	0	0.80	0.00	0.10
05:00-06:00	0.00	0.00	0.00	0.00	0	0.80	0.00	0.10
06:00-07:00	0.00	0.00	0.00	0.00	0	0.00	0.00	0.10
07:00-08:00	0.00	0.00	0.00	0.00	0	0.00	0.00	0.10
08:00-09:00	0.20	0.40	0.30	0.20	0	0.00	1.00	0.80
09:00-10:00	0.20	0.75	0.50	0.50	1	0.00	1.00	0.80
10:00-11:00	0.20	0.95	0.95	0.50	1	0.00	1.00	0.80
11:00-12:00	0.80	0.95	0.95	0.50	1	0.00	1.00	0.80
12:00-13:00	0.80	0.95	0.95	0.50	1	0.00	1.00	0.80
13:00-14:00	0.80	0.95	0.95	0.50	1	0.00	1.00	0.80
14:00-15:00	0.80	0.95	0.95	0.50	1	0.00	1.00	0.80
15:00-16:00	0.80	0.95	0.95	0.50	1	0.00	1.00	0.80
16:00-17:00	0.80	0.95	0.95	0.50	1	0.00	1.00	0.80
17:00-18:00	0.80	0.95	0.95	0.50	1	0.00	1.00	0.80
18:00-19:00	0.50	0.95	0.50	0.50	1	0.80	1.00	0.80
19:00-20:00	0.20	0.40	0.30	0.40	1	0.80	1.00	0.80
20:00-21:00	0.20	0.40	0.30	0.20	0	0.80	1.00	0.80
21:00-22:00	0.20	0.40	0.30	0.20	0	0.80	1.00	0.80
22:00-23:00	0.10	0.10	0.00	0.00	0	0.80	1.00	0.80
23:00-24:00	0.10	0.10	0.00	0.00	0	0.80	0.00	0.80

Table 9-11 Schedules for Business - Office Buildings

<i>Business - Office</i>							
<i>Time Period</i>	<i>HVAC Fan Schedule (On/Off)</i>		<i>External Lighting Schedule</i>	<i>Basement Ventilation</i>		<i>Basement Lighting</i>	
	<i>Daytime Business</i>	<i>24 Hours Business</i>	<i>7 Days/week</i>	<i>Daytime Business</i>	<i>24 Hours Business</i>	<i>Daytime Business</i>	<i>24 Hours Business</i>
00:00-01:00	0	1	0.80	0.00	1.00	0.05	1.00
01:00-02:00	0	1	0.80	0.00	1.00	0.05	1.00
02:00-03:00	0	1	0.80	0.00	1.00	0.05	1.00
03:00-04:00	0	1	0.80	0.00	1.00	0.05	1.00
04:00-05:00	0	1	0.80	0.00	1.00	0.05	1.00
05:00-06:00	0	1	0.80	0.00	1.00	0.05	1.00
06:00-07:00	0	1	0.00	0.00	1.00	0.05	1.00
07:00-08:00	1	1	0.00	0.00	1.00	0.05	1.00
08:00-09:00	1	1	0.00	1.00	1.00	1.00	1.00
09:00-10:00	1	1	0.00	1.00	1.00	1.00	1.00
10:00-11:00	1	1	0.00	1.00	1.00	1.00	1.00
11:00-12:00	1	1	0.00	1.00	1.00	1.00	1.00
12:00-13:00	1	1	0.00	1.00	1.00	1.00	1.00
13:00-14:00	1	1	0.00	1.00	1.00	1.00	1.00
14:00-15:00	1	1	0.00	1.00	1.00	1.00	1.00
15:00-16:00	1	1	0.00	1.00	1.00	1.00	1.00
16:00-17:00	1	1	0.00	1.00	1.00	1.00	1.00
17:00-18:00	1	1	0.00	1.00	1.00	1.00	1.00
18:00-19:00	1	1	0.80	1.00	1.00	1.00	1.00
19:00-20:00	1	1	0.80	1.00	1.00	1.00	1.00
20:00-21:00	1	1	0.80	1.00	1.00	1.00	1.00
21:00-22:00	1	1	0.80	0.00	1.00	0.05	1.00
22:00-23:00	0	1	0.80	0.00	1.00	0.05	1.00
23:00-24:00	0	1	0.80	0.00	1.00	0.05	1.00

Table 9-12 Schedules for Educational - School Buildings (A)

<i>Educational - School</i>						
<i>Time Period</i>	<i>Occupancy Schedule</i>		<i>Lighting Schedule</i>		<i>Equipment Schedule</i>	
	<i>Student Zone</i>	<i>Back Office</i>	<i>Student Zone</i>	<i>Back Office</i>	<i>Student Zone</i>	<i>Back Office</i>
	<i>5 Days/ week</i>	<i>5 Days/ week</i>	<i>5 Days/ week</i>	<i>5 Days/ week</i>	<i>5 Days/ week</i>	<i>5 Days/ week</i>
<i>00:00-01:00</i>	<i>0.00</i>	<i>0.00</i>	<i>0.00</i>	<i>0.00</i>	<i>0.00</i>	<i>0.00</i>
<i>01:00-02:00</i>	<i>0.00</i>	<i>0.00</i>	<i>0.00</i>	<i>0.00</i>	<i>0.00</i>	<i>0.00</i>
<i>02:00-03:00</i>	<i>0.00</i>	<i>0.00</i>	<i>0.00</i>	<i>0.00</i>	<i>0.00</i>	<i>0.00</i>
<i>03:00-04:00</i>	<i>0.00</i>	<i>0.00</i>	<i>0.00</i>	<i>0.00</i>	<i>0.00</i>	<i>0.00</i>
<i>04:00-05:00</i>	<i>0.00</i>	<i>0.00</i>	<i>0.00</i>	<i>0.00</i>	<i>0.00</i>	<i>0.00</i>
<i>05:00-06:00</i>	<i>0.00</i>	<i>0.00</i>	<i>0.00</i>	<i>0.00</i>	<i>0.00</i>	<i>0.00</i>
<i>06:00-07:00</i>	<i>0.00</i>	<i>0.00</i>	<i>0.00</i>	<i>0.20</i>	<i>0.00</i>	<i>0.00</i>
<i>07:00-08:00</i>	<i>0.70</i>	<i>0.00</i>	<i>0.90</i>	<i>0.70</i>	<i>0.35</i>	<i>0.35</i>
<i>08:00-09:00</i>	<i>0.90</i>	<i>0.90</i>	<i>0.90</i>	<i>0.90</i>	<i>0.95</i>	<i>0.95</i>
<i>09:00-10:00</i>	<i>0.90</i>	<i>0.90</i>	<i>0.90</i>	<i>0.90</i>	<i>0.95</i>	<i>0.95</i>
<i>10:00-11:00</i>	<i>0.90</i>	<i>0.90</i>	<i>0.90</i>	<i>0.90</i>	<i>0.95</i>	<i>0.95</i>
<i>11:00-12:00</i>	<i>0.20</i>	<i>0.90</i>	<i>0.20</i>	<i>0.90</i>	<i>0.20</i>	<i>0.95</i>
<i>12:00-13:00</i>	<i>0.90</i>	<i>0.90</i>	<i>0.90</i>	<i>0.90</i>	<i>0.95</i>	<i>0.95</i>
<i>13:00-14:00</i>	<i>0.90</i>	<i>0.20</i>	<i>0.90</i>	<i>0.30</i>	<i>0.95</i>	<i>0.40</i>
<i>14:00-15:00</i>	<i>0.00</i>	<i>0.90</i>	<i>0.00</i>	<i>0.90</i>	<i>0.00</i>	<i>0.95</i>
<i>15:00-16:00</i>	<i>0.00</i>	<i>0.90</i>	<i>0.00</i>	<i>0.90</i>	<i>0.00</i>	<i>0.95</i>
<i>16:00-17:00</i>	<i>0.00</i>	<i>0.90</i>	<i>0.00</i>	<i>0.90</i>	<i>0.00</i>	<i>0.95</i>
<i>17:00-18:00</i>	<i>0.00</i>	<i>0.50</i>	<i>0.00</i>	<i>0.30</i>	<i>0.00</i>	<i>0.25</i>
<i>18:00-19:00</i>	<i>0.00</i>	<i>0.00</i>	<i>0.00</i>	<i>0.10</i>	<i>0.00</i>	<i>0.00</i>
<i>19:00-20:00</i>	<i>0.00</i>	<i>0.00</i>	<i>0.00</i>	<i>0.00</i>	<i>0.00</i>	<i>0.00</i>
<i>20:00-21:00</i>	<i>0.00</i>	<i>0.00</i>	<i>0.00</i>	<i>0.00</i>	<i>0.00</i>	<i>0.00</i>
<i>21:00-22:00</i>	<i>0.00</i>	<i>0.00</i>	<i>0.00</i>	<i>0.00</i>	<i>0.00</i>	<i>0.00</i>
<i>22:00-23:00</i>	<i>0.00</i>	<i>0.00</i>	<i>0.00</i>	<i>0.00</i>	<i>0.00</i>	<i>0.00</i>
<i>23:00-24:00</i>	<i>0.00</i>	<i>0.00</i>	<i>0.00</i>	<i>0.00</i>	<i>0.00</i>	<i>0.00</i>

Schedules for Educational - School Buildings (B)

<i>Educational - School</i>						
<i>Time Period</i>	<i>Elevator Schedule</i>	<i>HVAC Fan Schedule (On/Off)</i>		<i>External Lighting Schedule</i>	<i>Basement Ventilation</i>	<i>Basement Lighting</i>
		<i>Student Area</i>	<i>Back Office</i>			
	<i>7 Days/week</i>	<i>5 Days/week</i>	<i>5 Days/week</i>	<i>7 Days/week</i>	<i>7 Days/week</i>	<i>7 Days/week</i>
<i>00:00-01:00</i>	<i>0.00</i>	<i>0</i>	<i>0</i>	<i>0.80</i>	<i>0.00</i>	<i>0.05</i>
<i>01:00-02:00</i>	<i>0.00</i>	<i>0</i>	<i>0</i>	<i>0.80</i>	<i>0.00</i>	<i>0.05</i>
<i>02:00-03:00</i>	<i>0.00</i>	<i>0</i>	<i>0</i>	<i>0.80</i>	<i>0.00</i>	<i>0.05</i>
<i>03:00-04:00</i>	<i>0.00</i>	<i>0</i>	<i>0</i>	<i>0.80</i>	<i>0.00</i>	<i>0.05</i>
<i>04:00-05:00</i>	<i>0.00</i>	<i>0</i>	<i>0</i>	<i>0.80</i>	<i>0.00</i>	<i>0.05</i>
<i>05:00-06:00</i>	<i>0.00</i>	<i>0</i>	<i>0</i>	<i>0.80</i>	<i>0.00</i>	<i>0.05</i>
<i>06:00-07:00</i>	<i>0.05</i>	<i>0</i>	<i>0</i>	<i>0.00</i>	<i>0.00</i>	<i>0.05</i>
<i>07:00-08:00</i>	<i>0.80</i>	<i>1</i>	<i>1</i>	<i>0.00</i>	<i>0.00</i>	<i>0.05</i>
<i>08:00-09:00</i>	<i>0.80</i>	<i>1</i>	<i>1</i>	<i>0.00</i>	<i>1.00</i>	<i>1.00</i>
<i>09:00-10:00</i>	<i>0.25</i>	<i>1</i>	<i>1</i>	<i>0.00</i>	<i>1.00</i>	<i>1.00</i>
<i>10:00-11:00</i>	<i>0.25</i>	<i>1</i>	<i>1</i>	<i>0.00</i>	<i>1.00</i>	<i>1.00</i>
<i>11:00-12:00</i>	<i>0.25</i>	<i>1</i>	<i>1</i>	<i>0.00</i>	<i>1.00</i>	<i>1.00</i>
<i>12:00-13:00</i>	<i>0.25</i>	<i>1</i>	<i>1</i>	<i>0.00</i>	<i>1.00</i>	<i>1.00</i>
<i>13:00-14:00</i>	<i>0.90</i>	<i>1</i>	<i>1</i>	<i>0.00</i>	<i>1.00</i>	<i>1.00</i>
<i>14:00-15:00</i>	<i>0.60</i>	<i>0</i>	<i>1</i>	<i>0.00</i>	<i>1.00</i>	<i>1.00</i>
<i>15:00-16:00</i>	<i>0.20</i>	<i>0</i>	<i>1</i>	<i>0.00</i>	<i>1.00</i>	<i>1.00</i>
<i>16:00-17:00</i>	<i>0.30</i>	<i>0</i>	<i>1</i>	<i>0.00</i>	<i>1.00</i>	<i>1.00</i>
<i>17:00-18:00</i>	<i>0.40</i>	<i>0</i>	<i>0</i>	<i>0.00</i>	<i>1.00</i>	<i>0.50</i>
<i>18:00-19:00</i>	<i>0.00</i>	<i>0</i>	<i>0</i>	<i>0.80</i>	<i>0.00</i>	<i>0.05</i>
<i>19:00-20:00</i>	<i>0.00</i>	<i>0</i>	<i>0</i>	<i>0.80</i>	<i>0.00</i>	<i>0.05</i>
<i>20:00-21:00</i>	<i>0.00</i>	<i>0</i>	<i>0</i>	<i>0.80</i>	<i>0.00</i>	<i>0.05</i>
<i>21:00-22:00</i>	<i>0.00</i>	<i>0</i>	<i>0</i>	<i>0.80</i>	<i>0.00</i>	<i>0.05</i>
<i>22:00-23:00</i>	<i>0.00</i>	<i>0</i>	<i>0</i>	<i>0.80</i>	<i>0.00</i>	<i>0.05</i>
<i>23:00-24:00</i>	<i>0.00</i>	<i>0</i>	<i>0</i>	<i>0.80</i>	<i>0.00</i>	<i>0.05</i>

Table 9-13 Schedules for Educational - University Buildings (A)

Educational - University									
Time Period	Occupancy Schedule			Lighting Schedule			Equipment Schedule		
	Student Zone	Back Office	& Library Computer Centre	Student Zone	Back Office	& Library Computer Centre	Student Zone	Back Office	Library & Computer Center
	5 Days/ week	5 Days/ week	7 Days/ week	5 Days/ week	5 Days/ week	7 Days/ week	5 Days/ week	5 Days/ week	7 Days/ week
00:00-01:00	0.00	0.00	0.00	0.00	0.00	0.00	0.00	0.10	0.10
01:00-02:00	0.00	0.00	0.00	0.00	0.00	0.00	0.00	0.10	0.10
02:00-03:00	0.00	0.00	0.00	0.00	0.00	0.00	0.00	0.10	0.10
03:00-04:00	0.00	0.00	0.00	0.00	0.00	0.00	0.00	0.10	0.10
04:00-05:00	0.00	0.00	0.00	0.00	0.00	0.00	0.00	0.10	0.10
05:00-06:00	0.00	0.00	0.00	0.00	0.00	0.00	0.00	0.10	0.10
06:00-07:00	0.00	0.00	0.00	0.00	0.00	0.00	0.00	0.10	0.10
07:00-08:00	0.40	0.00	0.00	0.90	0.00	0.00	0.35	0.35	0.10
08:00-09:00	0.90	0.90	0.30	0.90	0.90	0.90	0.95	0.95	0.70
09:00-10:00	0.90	0.90	0.40	0.90	0.90	0.90	0.95	0.95	0.70
10:00-11:00	0.90	0.90	0.50	0.90	0.90	0.90	0.95	0.95	0.70
11:00-12:00	0.90	0.90	0.50	0.90	0.90	0.90	0.95	0.95	0.70
12:00-13:00	0.90	0.90	0.50	0.90	0.90	0.90	0.95	0.95	0.70
13:00-14:00	0.10	0.20	0.20	0.60	0.30	0.20	0.20	0.40	0.70
14:00-15:00	0.90	0.90	0.50	0.90	0.90	0.90	0.95	0.95	0.70
15:00-16:00	0.90	0.90	0.50	0.90	0.90	0.90	0.95	0.95	0.70
16:00-17:00	0.90	0.90	0.50	0.90	0.90	0.90	0.95	0.95	0.70
17:00-18:00	0.40	0.00	0.50	0.90	0.50	0.90	0.95	0.10	0.80
18:00-19:00	0.00	0.00	0.60	0.00	0.00	0.90	0.00	0.10	0.80
19:00-20:00	0.00	0.00	0.60	0.00	0.00	0.90	0.00	0.10	0.80
20:00-21:00	0.00	0.00	0.60	0.00	0.00	0.90	0.00	0.10	0.80
21:00-22:00	0.00	0.00	0.60	0.00	0.00	0.90	0.00	0.10	0.80
22:00-23:00	0.00	0.00	0.60	0.00	0.00	0.90	0.00	0.10	0.80
23:00-24:00	0.00	0.00	0.00	0.00	0.00	0.00	0.00	0.10	0.00

Schedules for Educational - University Buildings (B)

University								
Time Period	Elevator Schedule		HVAC Fan Schedule (On/Off)			External Lighting Schedule	Basement Ventilation	Basement Lighting
	Library & Comp. Centre	Student and Back office	Student Area	Back Office	Library & Comp. Centre			
	7 days/ week	7 days/ week	5 days/ week	5 days/ week	7 days/ week			
00:00-01:00	0.00	0.00	0	0	0	0.80	0.00	0.05
01:00-02:00	0.00	0.00	0	0	0	0.80	0.00	0.05
02:00-03:00	0.00	0.00	0	0	0	0.80	0.00	0.05
03:00-04:00	0.00	0.00	0	0	0	0.80	0.00	0.05
04:00-05:00	0.00	0.00	0	0	0	0.80	0.00	0.05
05:00-06:00	0.00	0.00	0	0	0	0.80	0.00	0.05
06:00-07:00	0.00	0.05	0	0	0	0.00	0.00	0.05
07:00-08:00	0.00	0.25	1	1	1	0.00	0.00	0.05
08:00-09:00	0.50	0.85	1	1	1	0.00	1.00	1.00
09:00-10:00	0.50	0.25	1	1	1	0.00	1.00	1.00
10:00-11:00	0.30	0.25	1	1	1	0.00	1.00	1.00
11:00-12:00	0.20	0.25	1	1	1	0.00	1.00	1.00
12:00-13:00	0.20	0.25	1	1	1	0.00	1.00	1.00
13:00-14:00	0.40	0.90	1	1	1	0.00	1.00	1.00
14:00-15:00	0.30	0.60	1	1	1	0.00	1.00	1.00
15:00-16:00	0.30	0.25	1	1	1	0.00	1.00	1.00
16:00-17:00	0.30	0.25	1	1	1	0.00	1.00	1.00
17:00-18:00	0.50	0.90	1	0	1	0.00	1.00	1.00
18:00-19:00	0.50	0.15	0	0	1	0.80	1.00	1.00
19:00-20:00	0.50	0.05	0	0	1	0.80	1.00	1.00
20:00-21:00	0.50	0.00	0	0	1	0.80	0.00	0.50
21:00-22:00	0.50	0.00	0	0	1	0.80	0.00	0.05
22:00-23:00	0.50	0.00	0	0	1	0.80	0.00	0.05
23:00-24:00	0.00	0.00	0	0	0	0.80	0.00	0.05

Table 9-14 Schedules for Healthcare - Hospital Buildings (A)

Healthcare - Hospital								
Time Period	Occupancy Schedule				Lighting Schedule			
	In Patient & ICU	Public Spaces	OPD & Offices	Diagnostic, emergency & OT	Public Spaces	In Patient & ICU	Diagnostic, emergency, & OT	OPD & Offices
	7 days/ week	7 days/ week	6 days/ week	7 days/ week	7 days/ week	7 days/ week	7 days/ week	6 days/ week
00:00-01:00	0.90	0.00	0.00	0.50	0.10	0.10	0.50	0.05
01:00-02:00	0.90	0.00	0.00	0.40	0.10	0.10	0.50	0.05
02:00-03:00	0.90	0.00	0.00	0.40	0.10	0.10	0.50	0.05
03:00-04:00	0.90	0.00	0.00	0.40	0.10	0.10	0.50	0.05
04:00-05:00	0.90	0.00	0.00	0.40	0.10	0.10	0.50	0.05
05:00-06:00	0.90	0.00	0.00	0.40	0.10	0.10	0.50	0.05
06:00-07:00	0.90	0.00	0.00	0.50	0.10	0.10	0.50	0.10
07:00-08:00	0.90	0.10	0.10	0.70	0.50	0.20	0.50	0.30
08:00-09:00	0.90	0.50	0.30	0.70	0.90	0.20	0.90	0.90
09:00-10:00	0.90	0.95	0.90	0.95	0.90	0.20	0.90	0.90
10:00-11:00	0.90	0.95	0.90	0.95	0.90	0.20	0.90	0.90
11:00-12:00	0.90	0.95	0.50	0.95	0.90	0.20	0.90	0.90
12:00-13:00	0.90	0.95	0.20	0.95	0.90	0.20	0.90	0.90
13:00-14:00	0.90	0.95	0.50	0.95	0.90	0.20	0.90	0.50
14:00-15:00	0.90	0.95	0.90	0.95	0.90	0.20	0.90	0.90
15:00-16:00	0.90	0.95	0.90	0.95	0.90	0.20	0.90	0.90
16:00-17:00	0.90	0.95	0.90	0.95	0.30	0.20	0.90	0.90
17:00-18:00	0.90	0.70	0.90	0.95	0.30	0.70	0.90	0.90
18:00-19:00	0.90	0.50	0.50	0.95	0.30	0.90	0.90	0.50
19:00-20:00	0.90	0.30	0.50	0.95	0.30	0.90	0.90	0.50
20:00-21:00	0.90	0.10	0.50	0.70	0.30	0.90	0.50	0.30
21:00-22:00	0.90	0.00	0.10	0.70	0.30	0.90	0.50	0.20
22:00-23:00	0.90	0.00	0.00	0.50	0.30	0.70	0.50	0.10
23:00-24:00	0.90	0.00	0.00	0.50	0.10	0.10	0.50	0.05

Schedules for Healthcare - Hospital Buildings (B)

<i>Healthcare - Hospital</i>							
<i>Time Period</i>	<i>Equipment Schedule</i>					<i>Elevator Schedule</i>	
	<i>In Patient & ICU</i>	<i>Diagnostic, emergency, & OT</i>	<i>OPD Offices &</i>			<i>Elevator</i>	
	<i>7 days/ week</i>	<i>7 days/ week</i>	<i>7 days/ week</i>			<i>7 days/ week</i>	
<i>00-01 Hrs</i>	<i>0.40</i>	<i>0.00</i>	<i>0.00</i>			<i>0.20</i>	
<i>01-02 Hrs</i>	<i>0.40</i>	<i>0.00</i>	<i>0.00</i>			<i>0.20</i>	
<i>02-03 Hrs</i>	<i>0.40</i>	<i>0.00</i>	<i>0.00</i>			<i>0.20</i>	
<i>03-04 Hrs</i>	<i>0.40</i>	<i>0.00</i>	<i>0.00</i>			<i>0.20</i>	
<i>04-05 Hrs</i>	<i>0.40</i>	<i>0.00</i>	<i>0.00</i>			<i>0.20</i>	
<i>05-06 Hrs</i>	<i>0.40</i>	<i>0.00</i>	<i>0.00</i>			<i>0.20</i>	
<i>06-07 Hrs</i>	<i>0.40</i>	<i>0.00</i>	<i>0.00</i>			<i>0.20</i>	
<i>07-08 Hrs</i>	<i>0.70</i>	<i>0.70</i>	<i>0.70</i>			<i>0.50</i>	
<i>08-09 Hrs</i>	<i>0.90</i>	<i>0.90</i>	<i>0.90</i>			<i>0.75</i>	
<i>09-10 Hrs</i>	<i>0.90</i>	<i>0.90</i>	<i>0.90</i>			<i>1.00</i>	
<i>10-11 Hrs</i>	<i>0.90</i>	<i>0.90</i>	<i>0.90</i>			<i>1.00</i>	
<i>11-12 Hrs</i>	<i>0.90</i>	<i>0.90</i>	<i>0.90</i>			<i>1.00</i>	
<i>12-13 Hrs</i>	<i>0.90</i>	<i>0.90</i>	<i>0.90</i>			<i>0.75</i>	
<i>13-14 Hrs</i>	<i>0.90</i>	<i>0.90</i>	<i>0.90</i>			<i>1.00</i>	
<i>14-15 Hrs</i>	<i>0.90</i>	<i>0.90</i>	<i>0.90</i>			<i>1.00</i>	
<i>15-16 Hrs</i>	<i>0.90</i>	<i>0.90</i>	<i>0.90</i>			<i>1.00</i>	
<i>16-17 Hrs</i>	<i>0.60</i>	<i>0.60</i>	<i>0.90</i>			<i>1.00</i>	
<i>17-18 Hrs</i>	<i>0.60</i>	<i>0.60</i>	<i>0.90</i>			<i>1.00</i>	
<i>18-19 Hrs</i>	<i>0.60</i>	<i>0.60</i>	<i>0.60</i>			<i>0.50</i>	
<i>19-20 Hrs</i>	<i>0.60</i>	<i>0.60</i>	<i>0.60</i>			<i>0.50</i>	
<i>20-21 Hrs</i>	<i>0.60</i>	<i>0.60</i>	<i>0.60</i>			<i>0.50</i>	
<i>21-22 Hrs</i>	<i>0.60</i>	<i>0.00</i>	<i>0.00</i>			<i>0.30</i>	
<i>22-23 Hrs</i>	<i>0.60</i>	<i>0.00</i>	<i>0.00</i>			<i>0.20</i>	
<i>23-00 Hrs</i>	<i>0.40</i>	<i>0.00</i>	<i>0.00</i>			<i>0.20</i>	

Schedules for Healthcare - Hospital Buildings (C)

Healthcare - Hospital									
Time Period	HVAC Fan Schedule (On/Off)				External Lighting Schedule	Service Hot Water		Basement Ventilation	Basement Lighting
	Public Spaces	Beds & ICU	Diagn, emerg, & OT	OPD & Offices		Building Summer	Building Winters		
	7 days/ week	7 days/ week	7 days/ week	7 days/ week		7 days/ week	7 days/ week		
00:00-01:00	0	1	1	0	1.00	0.00	0.30	0.50	0.50
01:00-02:00	0	1	1	0	1.00	0.00	0.30	0.50	0.50
02:00-03:00	0	1	1	0	1.00	0.00	0.30	0.50	0.50
03:00-04:00	0	1	1	0	1.00	0.00	0.30	0.50	0.50
04:00-05:00	0	1	1	0	1.00	0.00	0.30	0.50	0.50
05:00-06:00	0	1	1	0	1.00	0.00	0.30	0.50	0.50
06:00-07:00	0	1	1	0	0.00	0.00	0.30	0.50	0.50
07:00-08:00	1	1	1	0	0.00	0.00	0.20	0.50	0.50
08:00-09:00	1	1	1	1	0.00	0.20	0.60	1.00	1.00
09:00-10:00	1	1	1	1	0.00	0.30	0.60	1.00	1.00
10:00-11:00	1	1	1	1	0.00	0.30	0.80	1.00	1.00
11:00-12:00	1	1	1	1	0.00	0.30	0.80	1.00	1.00
12:00-13:00	1	1	1	1	0.00	0.25	0.70	1.00	1.00
13:00-14:00	1	1	1	1	0.00	0.25	0.80	1.00	1.00
14:00-15:00	1	1	1	1	0.00	0.25	0.80	1.00	1.00
15:00-16:00	1	1	1	1	0.00	0.25	0.70	1.00	1.00
16:00-17:00	1	1	1	1	0.00	0.25	0.70	1.00	1.00
17:00-18:00	1	1	1	1	0.00	0.10	0.50	1.00	1.00
18:00-19:00	1	1	1	1	1.00	0.00	0.35	1.00	1.00
19:00-20:00	1	1	1	1	1.00	0.00	0.35	1.00	1.00
20:00-21:00	1	1	1	1	1.00	0.00	0.35	1.00	1.00
21:00-22:00	1	1	1	0	1.00	0.00	0.30	0.50	0.50
22:00-23:00	0	1	1	0	1.00	0.00	0.30	0.50	0.50
23:00-24:00	0	1	1	0	1.00	0.00	0.30	0.50	0.50

Table 9-15 Schedules for Healthcare – Out-patient Healthcare Buildings (A)

<i>Healthcare – Out-patient Healthcare</i>							
<i>Time Period</i>	<i>Occupancy Schedule</i>			<i>Lighting Schedule</i>		<i>Equipment Schedule</i>	
	<i>Lobby</i>	<i>Diagnostic & Emergency</i>	<i>OPD & Back Office</i>	<i>Diagnostic & Emergency</i>	<i>OPD & Back Office</i>	<i>Diagnostic & Emergency</i>	<i>OPD & Back Office</i>
	<i>6 days/ week</i>	<i>6 days/ week</i>	<i>6 days/ week</i>	<i>6 days/ week</i>	<i>6 days/ week</i>	<i>6 days/ week</i>	<i>6 days/ week</i>
<i>00:00-01:00</i>	<i>0.00</i>	<i>0.00</i>	<i>0.00</i>	<i>0.10</i>	<i>0.00</i>	<i>0.00</i>	<i>0.00</i>
<i>01:00-02:00</i>	<i>0.00</i>	<i>0.00</i>	<i>0.00</i>	<i>0.10</i>	<i>0.00</i>	<i>0.00</i>	<i>0.00</i>
<i>02:00-03:00</i>	<i>0.00</i>	<i>0.00</i>	<i>0.00</i>	<i>0.10</i>	<i>0.00</i>	<i>0.00</i>	<i>0.00</i>
<i>03:00-04:00</i>	<i>0.00</i>	<i>0.00</i>	<i>0.00</i>	<i>0.10</i>	<i>0.00</i>	<i>0.00</i>	<i>0.00</i>
<i>04:00-05:00</i>	<i>0.00</i>	<i>0.00</i>	<i>0.00</i>	<i>0.10</i>	<i>0.00</i>	<i>0.00</i>	<i>0.00</i>
<i>05:00-06:00</i>	<i>0.00</i>	<i>0.00</i>	<i>0.00</i>	<i>0.10</i>	<i>0.00</i>	<i>0.00</i>	<i>0.00</i>
<i>06:00-07:00</i>	<i>0.00</i>	<i>0.20</i>	<i>0.20</i>	<i>0.10</i>	<i>0.10</i>	<i>0.00</i>	<i>0.00</i>
<i>07:00-08:00</i>	<i>0.10</i>	<i>0.20</i>	<i>0.20</i>	<i>0.50</i>	<i>0.30</i>	<i>0.50</i>	<i>0.00</i>
<i>08:00-09:00</i>	<i>0.50</i>	<i>0.30</i>	<i>0.20</i>	<i>0.90</i>	<i>0.90</i>	<i>0.95</i>	<i>0.95</i>
<i>09:00-10:00</i>	<i>0.80</i>	<i>0.90</i>	<i>0.90</i>	<i>0.90</i>	<i>0.90</i>	<i>0.95</i>	<i>0.95</i>
<i>10:00-11:00</i>	<i>0.80</i>	<i>0.90</i>	<i>0.90</i>	<i>0.90</i>	<i>0.90</i>	<i>0.95</i>	<i>0.95</i>
<i>11:00-12:00</i>	<i>0.80</i>	<i>0.90</i>	<i>0.90</i>	<i>0.90</i>	<i>0.90</i>	<i>0.95</i>	<i>0.95</i>
<i>12:00-13:00</i>	<i>0.80</i>	<i>0.90</i>	<i>0.50</i>	<i>0.90</i>	<i>0.90</i>	<i>0.95</i>	<i>0.95</i>
<i>13:00-14:00</i>	<i>0.80</i>	<i>0.90</i>	<i>0.20</i>	<i>0.90</i>	<i>0.50</i>	<i>0.95</i>	<i>0.95</i>
<i>14:00-15:00</i>	<i>0.80</i>	<i>0.90</i>	<i>0.50</i>	<i>0.90</i>	<i>0.90</i>	<i>0.95</i>	<i>0.95</i>
<i>15:00-16:00</i>	<i>0.80</i>	<i>0.90</i>	<i>0.90</i>	<i>0.90</i>	<i>0.90</i>	<i>0.95</i>	<i>0.95</i>
<i>16:00-17:00</i>	<i>0.80</i>	<i>0.90</i>	<i>0.90</i>	<i>0.90</i>	<i>0.90</i>	<i>0.95</i>	<i>0.95</i>
<i>17:00-18:00</i>	<i>0.80</i>	<i>0.90</i>	<i>0.90</i>	<i>0.90</i>	<i>0.95</i>	<i>0.95</i>	<i>0.95</i>
<i>18:00-19:00</i>	<i>0.80</i>	<i>0.90</i>	<i>0.50</i>	<i>0.90</i>	<i>0.95</i>	<i>0.95</i>	<i>0.95</i>
<i>19:00-20:00</i>	<i>0.80</i>	<i>0.90</i>	<i>0.50</i>	<i>0.90</i>	<i>0.30</i>	<i>0.95</i>	<i>0.95</i>
<i>20:00-21:00</i>	<i>0.20</i>	<i>0.65</i>	<i>0.20</i>	<i>0.90</i>	<i>0.30</i>	<i>0.80</i>	<i>0.80</i>
<i>21:00-22:00</i>	<i>0.20</i>	<i>0.20</i>	<i>0.20</i>	<i>0.50</i>	<i>0.20</i>	<i>0.00</i>	<i>0.00</i>
<i>22:00-23:00</i>	<i>0.00</i>	<i>0.00</i>	<i>0.00</i>	<i>0.30</i>	<i>0.00</i>	<i>0.00</i>	<i>0.00</i>
<i>23:00-24:00</i>	<i>0.00</i>	<i>0.00</i>	<i>0.00</i>	<i>0.10</i>	<i>0.00</i>	<i>0.00</i>	<i>0.00</i>

Schedules for Healthcare – Out-patient Healthcare Buildings (B)

<i>Healthcare - Out-patient Healthcare</i>							
<i>Time Period</i>	<i>Elevator Schedule</i>	<i>HVAC Fan Schedule (On/Off)</i>	<i>External Lighting Schedule</i>	<i>Service Hot Water (SHW)</i>		<i>Basement Ventilation</i>	<i>Basement Lighting</i>
		<i>All Spaces</i>		<i>Building Summer</i>	<i>Building Winters</i>		
	<i>6 days/ week</i>	<i>6 days/ week</i>	<i>7 Days/ week</i>	<i>6 days/ week</i>	<i>6 days/ week</i>	<i>6 days/ week</i>	<i>6 days/ week</i>
<i>00:00-01:00</i>	<i>0.05</i>	<i>0</i>	<i>0.20</i>	<i>0.00</i>	<i>0.00</i>	<i>0.00</i>	<i>0.00</i>
<i>01:00-02:00</i>	<i>0.05</i>	<i>0</i>	<i>0.20</i>	<i>0.00</i>	<i>0.00</i>	<i>0.00</i>	<i>0.00</i>
<i>02:00-03:00</i>	<i>0.05</i>	<i>0</i>	<i>0.20</i>	<i>0.00</i>	<i>0.00</i>	<i>0.00</i>	<i>0.00</i>
<i>03:00-04:00</i>	<i>0.05</i>	<i>0</i>	<i>0.20</i>	<i>0.00</i>	<i>0.00</i>	<i>0.00</i>	<i>0.00</i>
<i>04:00-05:00</i>	<i>0.05</i>	<i>0</i>	<i>0.20</i>	<i>0.00</i>	<i>0.00</i>	<i>0.00</i>	<i>0.00</i>
<i>05:00-06:00</i>	<i>0.05</i>	<i>0</i>	<i>0.20</i>	<i>0.00</i>	<i>0.00</i>	<i>0.00</i>	<i>0.00</i>
<i>06:00-07:00</i>	<i>0.05</i>	<i>0</i>	<i>0.00</i>	<i>0.00</i>	<i>0.00</i>	<i>0.00</i>	<i>0.00</i>
<i>07:00-08:00</i>	<i>0.50</i>	<i>0</i>	<i>0.00</i>	<i>0.00</i>	<i>0.20</i>	<i>0.00</i>	<i>0.00</i>
<i>08:00-09:00</i>	<i>0.75</i>	<i>1</i>	<i>0.00</i>	<i>0.20</i>	<i>0.60</i>	<i>1.00</i>	<i>1.00</i>
<i>09:00-10:00</i>	<i>1.00</i>	<i>1</i>	<i>0.00</i>	<i>0.30</i>	<i>0.60</i>	<i>1.00</i>	<i>1.00</i>
<i>10:00-11:00</i>	<i>1.00</i>	<i>1</i>	<i>0.00</i>	<i>0.30</i>	<i>0.80</i>	<i>1.00</i>	<i>1.00</i>
<i>11:00-12:00</i>	<i>1.00</i>	<i>1</i>	<i>0.00</i>	<i>0.30</i>	<i>0.80</i>	<i>1.00</i>	<i>1.00</i>
<i>12:00-13:00</i>	<i>0.75</i>	<i>1</i>	<i>0.00</i>	<i>0.25</i>	<i>0.70</i>	<i>1.00</i>	<i>1.00</i>
<i>13:00-14:00</i>	<i>1.00</i>	<i>1</i>	<i>0.00</i>	<i>0.25</i>	<i>0.80</i>	<i>1.00</i>	<i>1.00</i>
<i>14:00-15:00</i>	<i>1.00</i>	<i>1</i>	<i>0.00</i>	<i>0.25</i>	<i>0.80</i>	<i>1.00</i>	<i>1.00</i>
<i>15:00-16:00</i>	<i>1.00</i>	<i>1</i>	<i>0.00</i>	<i>0.25</i>	<i>0.70</i>	<i>1.00</i>	<i>1.00</i>
<i>16:00-17:00</i>	<i>1.00</i>	<i>1</i>	<i>0.00</i>	<i>0.25</i>	<i>0.70</i>	<i>1.00</i>	<i>1.00</i>
<i>17:00-18:00</i>	<i>1.00</i>	<i>1</i>	<i>0.00</i>	<i>0.10</i>	<i>0.50</i>	<i>1.00</i>	<i>1.00</i>
<i>18:00-19:00</i>	<i>0.50</i>	<i>1</i>	<i>0.50</i>	<i>0.01</i>	<i>0.20</i>	<i>1.00</i>	<i>1.00</i>
<i>19:00-20:00</i>	<i>0.50</i>	<i>1</i>	<i>0.50</i>	<i>0.01</i>	<i>0.20</i>	<i>1.00</i>	<i>1.00</i>
<i>20:00-21:00</i>	<i>0.50</i>	<i>1</i>	<i>0.50</i>	<i>0.01</i>	<i>0.20</i>	<i>1.00</i>	<i>1.00</i>
<i>21:00-22:00</i>	<i>0.30</i>	<i>0</i>	<i>0.50</i>	<i>0.01</i>	<i>0.10</i>	<i>1.00</i>	<i>1.00</i>
<i>22:00-23:00</i>	<i>0.05</i>	<i>0</i>	<i>0.20</i>	<i>0.01</i>	<i>0.01</i>	<i>0.00</i>	<i>0.00</i>
<i>23:00-24:00</i>	<i>0.05</i>	<i>0</i>	<i>0.20</i>	<i>0.01</i>	<i>0.01</i>	<i>0.00</i>	<i>0.00</i>

Table 9-16 Schedules for Hospitality Buildings (A)

<i>Hospitality</i>								
<i>Time Period</i>	<i>Occupancy Schedule</i>							
	<i>Guest Room</i>		<i>Lobby</i>		<i>Special Zones</i>		<i>Restaurant</i>	
	<i>Week Days</i>	<i>Weekends</i>	<i>Week Days</i>	<i>Weekends</i>	<i>Week Days</i>	<i>Weekends</i>	<i>Week Days</i>	<i>Weekends</i>
00:00-01:00	0.65	0.90	0.10	0.10	0.00	0.00	0.00	0.00
01:00-02:00	0.65	0.90	0.10	0.10	0.00	0.00	0.00	0.00
02:00-03:00	0.65	0.90	0.10	0.10	0.00	0.00	0.00	0.00
03:00-04:00	0.65	0.90	0.10	0.10	0.00	0.00	0.00	0.00
04:00-05:00	0.65	0.90	0.10	0.10	0.00	0.00	0.00	0.00
05:00-06:00	0.65	0.90	0.10	0.10	0.20	0.50	0.00	0.00
06:00-07:00	0.50	0.70	0.20	0.20	0.40	0.70	0.30	0.50
07:00-08:00	0.50	0.70	0.30	0.40	0.40	0.70	0.50	0.80
08:00-09:00	0.30	0.50	0.40	0.70	0.40	0.70	0.50	0.80
09:00-10:00	0.15	0.30	0.40	0.70	0.40	0.70	0.50	0.80
10:00-11:00	0.15	0.20	0.40	0.70	0.40	0.70	0.50	0.80
11:00-12:00	0.15	0.20	0.40	0.70	0.20	0.30	0.00	0.00
12:00-13:00	0.15	0.20	0.40	0.70	0.20	0.30	0.00	0.00
13:00-14:00	0.15	0.20	0.20	0.20	0.20	0.30	0.50	0.50
14:00-15:00	0.15	0.20	0.20	0.20	0.20	0.30	0.50	0.80
15:00-16:00	0.15	0.20	0.20	0.20	0.40	0.70	0.00	0.80
16:00-17:00	0.15	0.20	0.20	0.20	0.40	0.70	0.30	0.30
17:00-18:00	0.30	0.30	0.40	0.40	0.40	0.70	0.30	0.30
18:00-19:00	0.50	0.50	0.40	0.40	0.40	0.70	0.00	0.00
19:00-20:00	0.50	0.70	0.40	0.40	0.40	0.70	0.30	0.50
20:00-21:00	0.65	0.70	0.30	0.30	0.00	0.00	0.50	0.90
21:00-22:00	0.65	0.90	0.20	0.20	0.00	0.00	0.50	0.90
22:00-23:00	0.65	0.90	0.10	0.10	0.00	0.00	0.50	0.90
23:00-24:00	0.65	0.90	0.10	0.10	0.00	0.00	0.50	0.90

Schedules for Hospitality Buildings (B)

Hospitality								
Time Period	Occupancy Schedule				Lighting Schedule			
	Back office		Conference/ Banquet Rooms	Kitchen	Public Spaces		Guest Rooms	
	Week Days	Weekends	7 Days/ week	7 Days/ week	Week Days	Weekends	Week Days	Weekends
00:00-01:00	0.20	0.20	0.00	0.00	0.20	0.20	0.20	0.30
01:00-02:00	0.20	0.20	0.00	0.00	0.15	0.20	0.20	0.25
02:00-03:00	0.20	0.20	0.00	0.00	0.10	0.10	0.10	0.10
03:00-04:00	0.20	0.20	0.00	0.00	0.10	0.10	0.10	0.10
04:00-05:00	0.20	0.20	0.00	0.00	0.10	0.10	0.10	0.10
05:00-06:00	0.20	0.20	0.00	0.00	0.20	0.10	0.20	0.10
06:00-07:00	0.20	0.20	0.00	0.50	0.40	0.30	0.45	0.40
07:00-08:00	0.20	0.20	0.00	0.80	0.50	0.30	0.55	0.40
08:00-09:00	0.20	0.20	0.20	0.80	0.40	0.40	0.45	0.55
09:00-10:00	0.95	0.50	0.50	0.50	0.20	0.40	0.20	0.20
10:00-11:00	0.95	0.50	0.90	0.50	0.20	0.40	0.20	0.20
11:00-12:00	0.95	0.50	0.90	0.80	0.20	0.40	0.20	0.20
12:00-13:00	0.95	0.50	0.90	0.80	0.20	0.40	0.20	0.20
13:00-14:00	0.50	0.30	0.90	0.80	0.20	0.40	0.20	0.20
14:00-15:00	0.95	0.50	0.90	0.50	0.20	0.40	0.20	0.20
15:00-16:00	0.95	0.50	0.90	0.50	0.20	0.40	0.20	0.20
16:00-17:00	0.95	0.50	0.90	0.50	0.20	0.40	0.20	0.20
17:00-18:00	0.95	0.50	0.50	0.80	0.25	0.40	0.30	0.30
18:00-19:00	0.30	0.30	0.20	0.80	0.60	0.60	0.70	0.85
19:00-20:00	0.20	0.20	0.20	0.80	0.80	0.70	0.90	1.00
20:00-21:00	0.20	0.20	0.00	0.80	0.90	0.70	1.00	1.00
21:00-22:00	0.20	0.20	0.00	0.80	0.80	0.70	0.90	1.00
22:00-23:00	0.20	0.20	0.00	0.50	0.60	0.60	0.70	0.85
23:00-24:00	0.20	0.20	0.00	0.50	0.30	0.30	0.30	0.40

Schedules for Hospitality Buildings (C)

<i>Hospitality</i>									
<i>Time Period</i>	<i>Lighting Schedule</i>			<i>Equipment Schedule</i>					
	<i>Back Office</i>		<i>Kitchen</i>	<i>Public Spaces</i>	<i>Guest Rooms</i>		<i>Back Office</i>		<i>Kitchen</i>
	<i>Week Days</i>	<i>Weekends</i>	<i>7 Days/ week</i>	<i>7 Days/ week</i>	<i>Week Days</i>	<i>Weekends</i>	<i>Week Days</i>	<i>Weekends</i>	<i>7 Days/ week</i>
00:00-01:00	0.05	0.05	0.50	0.30	0.20	0.20	0.05	0.05	0.30
01:00-02:00	0.05	0.05	0.05	0.20	0.20	0.20	0.05	0.05	0.10
02:00-03:00	0.05	0.05	0.05	0.20	0.20	0.20	0.05	0.05	0.10
03:00-04:00	0.05	0.05	0.05	0.20	0.20	0.20	0.05	0.05	0.10
04:00-05:00	0.05	0.05	0.05	0.20	0.20	0.20	0.05	0.05	0.10
05:00-06:00	0.05	0.05	0.05	0.30	0.20	0.20	0.05	0.05	0.10
06:00-07:00	0.10	0.10	0.10	0.50	0.30	0.30	0.05	0.05	0.30
07:00-08:00	0.30	0.30	0.30	0.50	0.40	0.60	0.10	0.10	0.30
08:00-09:00	0.90	0.60	0.90	0.50	0.70	0.90	0.30	0.30	0.30
09:00-10:00	0.90	0.60	0.90	0.50	0.20	0.20	0.95	0.70	0.30
10:00-11:00	0.90	0.60	0.90	0.35	0.20	0.20	0.95	0.70	0.30
11:00-12:00	0.90	0.60	0.90	0.35	0.20	0.20	0.95	0.70	0.30
12:00-13:00	0.90	0.60	0.90	0.35	0.20	0.20	0.95	0.70	0.30
13:00-14:00	0.50	0.50	0.50	0.35	0.20	0.20	0.50	0.70	0.30
14:00-15:00	0.90	0.60	0.90	0.35	0.20	0.20	0.95	0.70	0.30
15:00-16:00	0.90	0.60	0.90	0.35	0.20	0.20	0.95	0.70	0.30
16:00-17:00	0.90	0.60	0.90	0.35	0.20	0.20	0.95	0.70	0.30
17:00-18:00	0.95	0.60	0.95	0.35	0.30	0.30	0.95	0.70	0.30
18:00-19:00	0.50	0.50	0.95	0.70	0.50	0.50	0.30	0.30	0.30
19:00-20:00	0.30	0.30	0.95	0.90	0.50	0.50	0.10	0.10	0.30
20:00-21:00	0.30	0.30	0.95	0.90	0.50	0.70	0.10	0.10	0.30
21:00-22:00	0.20	0.20	0.95	0.90	0.70	0.70	0.10	0.10	0.30
22:00-23:00	0.10	0.10	0.95	0.70	0.40	0.40	0.05	0.05	0.30
23:00-24:00	0.05	0.05	0.95	0.40	0.20	0.20	0.05	0.05	0.30

Schedules for Hospitality Buildings (D)

<i>Hospitality</i>						
<i>Time Period</i>	<i>Elevator Schedule</i>		<i>HVAC Fan Schedule (On/Off)</i>			
			<i>Public Spaces</i>	<i>Guest Room</i>		<i>Back office</i>
	<i>Week Days</i>	<i>Weekends</i>	<i>7 Days/ week</i>	<i>Week Days</i>	<i>Weekends</i>	<i>7 Days/ week</i>
<i>00:00-01:00</i>	<i>0.10</i>	<i>0.10</i>	<i>0</i>	<i>1</i>	<i>1</i>	<i>0</i>
<i>01:00-02:00</i>	<i>0.10</i>	<i>0.10</i>	<i>0</i>	<i>1</i>	<i>1</i>	<i>0</i>
<i>02:00-03:00</i>	<i>0.10</i>	<i>0.10</i>	<i>0</i>	<i>1</i>	<i>1</i>	<i>0</i>
<i>03:00-04:00</i>	<i>0.10</i>	<i>0.10</i>	<i>0</i>	<i>1</i>	<i>1</i>	<i>0</i>
<i>04:00-05:00</i>	<i>0.10</i>	<i>0.10</i>	<i>0</i>	<i>1</i>	<i>1</i>	<i>0</i>
<i>05:00-06:00</i>	<i>0.20</i>	<i>0.20</i>	<i>0</i>	<i>1</i>	<i>1</i>	<i>0</i>
<i>06:00-07:00</i>	<i>0.40</i>	<i>0.50</i>	<i>0</i>	<i>1</i>	<i>1</i>	<i>0</i>
<i>07:00-08:00</i>	<i>0.50</i>	<i>0.60</i>	<i>1</i>	<i>1</i>	<i>1</i>	<i>0</i>
<i>08:00-09:00</i>	<i>0.50</i>	<i>0.60</i>	<i>1</i>	<i>1</i>	<i>1</i>	<i>1</i>
<i>09:00-10:00</i>	<i>0.35</i>	<i>0.40</i>	<i>1</i>	<i>1</i>	<i>1</i>	<i>1</i>
<i>10:00-11:00</i>	<i>0.15</i>	<i>0.20</i>	<i>1</i>	<i>1</i>	<i>1</i>	<i>1</i>
<i>11:00-12:00</i>	<i>0.15</i>	<i>0.20</i>	<i>1</i>	<i>1</i>	<i>1</i>	<i>1</i>
<i>12:00-13:00</i>	<i>0.15</i>	<i>0.20</i>	<i>1</i>	<i>1</i>	<i>1</i>	<i>1</i>
<i>13:00-14:00</i>	<i>0.15</i>	<i>0.20</i>	<i>1</i>	<i>1</i>	<i>1</i>	<i>1</i>
<i>14:00-15:00</i>	<i>0.15</i>	<i>0.20</i>	<i>1</i>	<i>1</i>	<i>1</i>	<i>1</i>
<i>15:00-16:00</i>	<i>0.15</i>	<i>0.20</i>	<i>1</i>	<i>1</i>	<i>1</i>	<i>1</i>
<i>16:00-17:00</i>	<i>0.35</i>	<i>0.40</i>	<i>1</i>	<i>1</i>	<i>1</i>	<i>1</i>
<i>17:00-18:00</i>	<i>0.50</i>	<i>0.60</i>	<i>1</i>	<i>1</i>	<i>1</i>	<i>1</i>
<i>18:00-19:00</i>	<i>0.50</i>	<i>0.60</i>	<i>1</i>	<i>1</i>	<i>1</i>	<i>1</i>
<i>19:00-20:00</i>	<i>0.50</i>	<i>0.60</i>	<i>1</i>	<i>1</i>	<i>1</i>	<i>0</i>
<i>20:00-21:00</i>	<i>0.50</i>	<i>0.60</i>	<i>1</i>	<i>1</i>	<i>1</i>	<i>0</i>
<i>21:00-22:00</i>	<i>0.30</i>	<i>0.40</i>	<i>1</i>	<i>1</i>	<i>1</i>	<i>0</i>
<i>22:00-23:00</i>	<i>0.20</i>	<i>0.30</i>	<i>1</i>	<i>1</i>	<i>1</i>	<i>0</i>
<i>23:00-24:00</i>	<i>0.10</i>	<i>0.10</i>	<i>1</i>	<i>1</i>	<i>1</i>	<i>0</i>

Schedules for Hospitality Buildings (E)

<i>Hospitality</i>						
<i>Time Period</i>	<i>External Lighting Schedule</i>	<i>Service Hot Water (SHW)</i>			<i>Basement Ventilation</i>	<i>Basement Lighting</i>
		<i>Guest rooms</i>		<i>Laundry</i>		
	<i>7 Days/ week</i>	<i>Week Days</i>	<i>Weekends</i>	<i>7 Days/ week</i>	<i>7 Days/ week</i>	<i>7 Days/ week</i>
<i>00:00-01:00</i>	<i>1.00</i>	<i>0.01</i>	<i>0.01</i>	<i>0.00</i>	<i>0.50</i>	<i>0.50</i>
<i>01:00-02:00</i>	<i>1.00</i>	<i>0.01</i>	<i>0.01</i>	<i>0.00</i>	<i>0.50</i>	<i>0.50</i>
<i>02:00-03:00</i>	<i>1.00</i>	<i>0.01</i>	<i>0.01</i>	<i>0.00</i>	<i>0.50</i>	<i>0.50</i>
<i>03:00-04:00</i>	<i>1.00</i>	<i>0.01</i>	<i>0.01</i>	<i>0.00</i>	<i>0.50</i>	<i>0.50</i>
<i>04:00-05:00</i>	<i>1.00</i>	<i>0.01</i>	<i>0.01</i>	<i>0.00</i>	<i>0.50</i>	<i>0.50</i>
<i>05:00-06:00</i>	<i>1.00</i>	<i>0.01</i>	<i>0.01</i>	<i>0.00</i>	<i>0.50</i>	<i>0.50</i>
<i>06:00-07:00</i>	<i>0.00</i>	<i>0.50</i>	<i>0.70</i>	<i>0.00</i>	<i>0.50</i>	<i>0.50</i>
<i>07:00-08:00</i>	<i>0.00</i>	<i>0.50</i>	<i>0.70</i>	<i>0.00</i>	<i>0.50</i>	<i>0.50</i>
<i>08:00-09:00</i>	<i>0.00</i>	<i>0.30</i>	<i>0.50</i>	<i>1.00</i>	<i>1.00</i>	<i>1.00</i>
<i>09:00-10:00</i>	<i>0.00</i>	<i>0.15</i>	<i>0.30</i>	<i>1.00</i>	<i>1.00</i>	<i>1.00</i>
<i>10:00-11:00</i>	<i>0.00</i>	<i>0.15</i>	<i>0.20</i>	<i>1.00</i>	<i>1.00</i>	<i>1.00</i>
<i>11:00-12:00</i>	<i>0.00</i>	<i>0.15</i>	<i>0.20</i>	<i>1.00</i>	<i>1.00</i>	<i>1.00</i>
<i>12:00-13:00</i>	<i>0.00</i>	<i>0.15</i>	<i>0.20</i>	<i>1.00</i>	<i>1.00</i>	<i>1.00</i>
<i>13:00-14:00</i>	<i>0.00</i>	<i>0.15</i>	<i>0.20</i>	<i>1.00</i>	<i>1.00</i>	<i>1.00</i>
<i>14:00-15:00</i>	<i>0.00</i>	<i>0.15</i>	<i>0.20</i>	<i>1.00</i>	<i>1.00</i>	<i>1.00</i>
<i>15:00-16:00</i>	<i>0.00</i>	<i>0.15</i>	<i>0.20</i>	<i>1.00</i>	<i>1.00</i>	<i>1.00</i>
<i>16:00-17:00</i>	<i>0.00</i>	<i>0.15</i>	<i>0.20</i>	<i>0.00</i>	<i>1.00</i>	<i>1.00</i>
<i>17:00-18:00</i>	<i>0.00</i>	<i>0.30</i>	<i>0.30</i>	<i>0.00</i>	<i>1.00</i>	<i>1.00</i>
<i>18:00-19:00</i>	<i>1.00</i>	<i>0.50</i>	<i>0.50</i>	<i>0.00</i>	<i>1.00</i>	<i>1.00</i>
<i>19:00-20:00</i>	<i>1.00</i>	<i>0.50</i>	<i>0.70</i>	<i>0.00</i>	<i>1.00</i>	<i>1.00</i>
<i>20:00-21:00</i>	<i>1.00</i>	<i>0.65</i>	<i>0.70</i>	<i>0.00</i>	<i>1.00</i>	<i>1.00</i>
<i>21:00-22:00</i>	<i>1.00</i>	<i>0.65</i>	<i>0.90</i>	<i>0.00</i>	<i>0.50</i>	<i>0.50</i>
<i>22:00-23:00</i>	<i>1.00</i>	<i>0.01</i>	<i>0.01</i>	<i>0.00</i>	<i>0.50</i>	<i>0.50</i>
<i>23:00-24:00</i>	<i>1.00</i>	<i>0.01</i>	<i>0.01</i>	<i>0.00</i>	<i>0.50</i>	<i>0.50</i>

Table 9-17 Schedules for Shopping Complexes Buildings (A)

Shopping Complex									
Time Period	Occupancy Schedule						Lighting Schedule		
	Retail		Corridors & Atrium		Special Zone		Retail	Corridors & Atrium	Special Zone
	Weekday	Weekend	Weekday	Weekend	Weekday	Weekend	7 Days/week	7 Days/week	7 Days/week
00:00-01:00	0.00	0.00	0.00	0.10	0.00	0.00	0.05	0.05	0.05
01:00-02:00	0.00	0.00	0.00	0.00	0.00	0.00	0.05	0.05	0.05
02:00-03:00	0.00	0.00	0.00	0.00	0.00	0.00	0.05	0.05	0.05
03:00-04:00	0.00	0.00	0.00	0.00	0.00	0.00	0.05	0.05	0.05
04:00-05:00	0.00	0.00	0.00	0.00	0.00	0.00	0.05	0.05	0.05
05:00-06:00	0.00	0.00	0.00	0.00	0.00	0.00	0.05	0.05	0.05
06:00-07:00	0.00	0.00	0.00	0.00	0.00	0.00	0.05	0.05	0.05
07:00-08:00	0.00	0.00	0.00	0.00	0.00	0.00	0.05	0.05	0.05
08:00-09:00	0.00	0.00	0.00	0.00	0.00	0.00	0.05	0.05	0.05
09:00-10:00	0.20	0.20	0.20	0.20	0.20	0.20	0.20	0.20	0.20
10:00-11:00	0.40	0.40	0.40	0.40	0.20	0.20	0.50	0.50	0.40
11:00-12:00	0.60	0.60	0.60	0.60	0.30	0.50	0.95	0.50	0.60
12:00-13:00	0.60	0.70	0.60	0.70	0.50	0.70	0.95	0.50	0.60
13:00-14:00	0.60	0.90	0.60	0.90	0.50	0.70	0.95	0.50	0.60
14:00-15:00	0.70	0.90	0.70	0.90	0.50	0.70	0.95	0.50	0.60
15:00-16:00	0.70	0.90	0.70	0.90	0.50	0.80	0.95	0.50	0.40
16:00-17:00	0.70	0.90	0.70	0.90	0.50	0.80	0.95	0.70	0.40
17:00-18:00	0.70	0.90	0.70	0.90	0.50	0.80	0.95	0.95	0.40
18:00-19:00	0.90	0.95	0.90	0.95	0.60	0.95	0.95	0.95	0.80
19:00-20:00	0.90	0.95	0.90	0.95	0.60	0.95	0.95	0.95	0.80
20:00-21:00	0.90	0.95	0.90	0.95	0.60	0.95	0.95	0.95	0.80
21:00-22:00	0.00	0.00	0.40	0.40	0.60	0.95	0.05	0.50	0.80
22:00-23:00	0.00	0.00	0.30	0.30	0.60	0.95	0.05	0.30	0.80
23:00-24:00	0.00	0.00	0.10	0.10	0.30	0.95	0.05	0.30	0.80

Schedules for Shopping Complexes Buildings (B)

<i>Shopping Complex</i>				
<i>Time Period</i>	<i>Equipment Schedule</i>		<i>Elevator Schedule</i>	
	<i>Retail</i>	<i>Special Zone</i>		
	<i>7 Days/ week</i>	<i>7 Days/ week</i>	<i>Weekdays</i>	<i>Weekends</i>
<i>00:00-01:00</i>	<i>0.05</i>	<i>0.05</i>	<i>0.20</i>	<i>0.20</i>
<i>01:00-02:00</i>	<i>0.05</i>	<i>0.05</i>	<i>0.05</i>	<i>0.20</i>
<i>02:00-03:00</i>	<i>0.05</i>	<i>0.05</i>	<i>0.05</i>	<i>0.05</i>
<i>03:00-04:00</i>	<i>0.05</i>	<i>0.05</i>	<i>0.05</i>	<i>0.05</i>
<i>04:00-05:00</i>	<i>0.05</i>	<i>0.05</i>	<i>0.05</i>	<i>0.05</i>
<i>05:00-06:00</i>	<i>0.05</i>	<i>0.05</i>	<i>0.05</i>	<i>0.05</i>
<i>06:00-07:00</i>	<i>0.05</i>	<i>0.05</i>	<i>0.05</i>	<i>0.05</i>
<i>07:00-08:00</i>	<i>0.05</i>	<i>0.05</i>	<i>0.10</i>	<i>0.10</i>
<i>08:00-09:00</i>	<i>0.05</i>	<i>0.50</i>	<i>0.10</i>	<i>0.10</i>
<i>09:00-10:00</i>	<i>0.05</i>	<i>0.50</i>	<i>0.20</i>	<i>0.20</i>
<i>10:00-11:00</i>	<i>0.90</i>	<i>0.90</i>	<i>0.40</i>	<i>0.40</i>
<i>11:00-12:00</i>	<i>0.90</i>	<i>0.90</i>	<i>0.70</i>	<i>0.70</i>
<i>12:00-13:00</i>	<i>0.90</i>	<i>0.90</i>	<i>0.70</i>	<i>0.80</i>
<i>13:00-14:00</i>	<i>0.90</i>	<i>0.90</i>	<i>0.70</i>	<i>0.95</i>
<i>14:00-15:00</i>	<i>0.90</i>	<i>0.90</i>	<i>0.70</i>	<i>0.95</i>
<i>15:00-16:00</i>	<i>0.90</i>	<i>0.90</i>	<i>0.70</i>	<i>0.95</i>
<i>16:00-17:00</i>	<i>0.90</i>	<i>0.90</i>	<i>0.70</i>	<i>0.95</i>
<i>17:00-18:00</i>	<i>0.90</i>	<i>0.90</i>	<i>0.80</i>	<i>0.95</i>
<i>18:00-19:00</i>	<i>0.90</i>	<i>0.90</i>	<i>0.80</i>	<i>0.95</i>
<i>19:00-20:00</i>	<i>0.90</i>	<i>0.90</i>	<i>0.80</i>	<i>0.95</i>
<i>20:00-21:00</i>	<i>0.50</i>	<i>0.90</i>	<i>0.80</i>	<i>0.95</i>
<i>21:00-22:00</i>	<i>0.05</i>	<i>0.90</i>	<i>0.80</i>	<i>0.80</i>
<i>22:00-23:00</i>	<i>0.05</i>	<i>0.90</i>	<i>0.50</i>	<i>0.60</i>
<i>23:00-24:00</i>	<i>0.05</i>	<i>0.90</i>	<i>0.30</i>	<i>0.40</i>

Schedules for Shopping Complexes Buildings (C)

<i>Shopping Complex</i>						
<i>Time Period</i>	<i>HVAC Fan Schedule (On/Off)</i>			<i>External Lighting Schedule</i>	<i>Basement Ventilation</i>	<i>Basement Lighting</i>
	<i>Retail</i>	<i>Corridors & Atrium</i>	<i>Special Zones</i>			
	<i>7 Days/ week</i>	<i>7 Days/ week</i>	<i>7 Days/ week</i>			
<i>00:00-01:00</i>	<i>0</i>	<i>0</i>	<i>0</i>	<i>1.00</i>	<i>1.00</i>	<i>1.00</i>
<i>01:00-02:00</i>	<i>0</i>	<i>0</i>	<i>0</i>	<i>0.50</i>	<i>0.00</i>	<i>0.05</i>
<i>02:00-03:00</i>	<i>0</i>	<i>0</i>	<i>0</i>	<i>0.50</i>	<i>0.00</i>	<i>0.05</i>
<i>03:00-04:00</i>	<i>0</i>	<i>0</i>	<i>0</i>	<i>0.50</i>	<i>0.00</i>	<i>0.05</i>
<i>04:00-05:00</i>	<i>0</i>	<i>0</i>	<i>0</i>	<i>0.50</i>	<i>0.00</i>	<i>0.05</i>
<i>05:00-06:00</i>	<i>0</i>	<i>0</i>	<i>0</i>	<i>0.50</i>	<i>0.00</i>	<i>0.05</i>
<i>06:00-07:00</i>	<i>0</i>	<i>0</i>	<i>0</i>	<i>0.00</i>	<i>0.00</i>	<i>0.05</i>
<i>07:00-08:00</i>	<i>0</i>	<i>0</i>	<i>0</i>	<i>0.00</i>	<i>0.00</i>	<i>0.05</i>
<i>08:00-09:00</i>	<i>0</i>	<i>0</i>	<i>0</i>	<i>0.00</i>	<i>0.00</i>	<i>0.05</i>
<i>09:00-10:00</i>	<i>0</i>	<i>1</i>	<i>1</i>	<i>0.00</i>	<i>1.00</i>	<i>1.00</i>
<i>10:00-11:00</i>	<i>1</i>	<i>1</i>	<i>1</i>	<i>0.00</i>	<i>1.00</i>	<i>1.00</i>
<i>11:00-12:00</i>	<i>1</i>	<i>1</i>	<i>1</i>	<i>0.00</i>	<i>1.00</i>	<i>1.00</i>
<i>12:00-13:00</i>	<i>1</i>	<i>1</i>	<i>1</i>	<i>0.00</i>	<i>1.00</i>	<i>1.00</i>
<i>13:00-14:00</i>	<i>1</i>	<i>1</i>	<i>1</i>	<i>0.00</i>	<i>1.00</i>	<i>1.00</i>
<i>14:00-15:00</i>	<i>1</i>	<i>1</i>	<i>1</i>	<i>0.00</i>	<i>1.00</i>	<i>1.00</i>
<i>15:00-16:00</i>	<i>1</i>	<i>1</i>	<i>1</i>	<i>0.00</i>	<i>1.00</i>	<i>1.00</i>
<i>16:00-17:00</i>	<i>1</i>	<i>1</i>	<i>1</i>	<i>0.00</i>	<i>1.00</i>	<i>1.00</i>
<i>17:00-18:00</i>	<i>1</i>	<i>1</i>	<i>1</i>	<i>0.00</i>	<i>1.00</i>	<i>1.00</i>
<i>18:00-19:00</i>	<i>1</i>	<i>1</i>	<i>1</i>	<i>1.00</i>	<i>1.00</i>	<i>1.00</i>
<i>19:00-20:00</i>	<i>1</i>	<i>1</i>	<i>1</i>	<i>1.00</i>	<i>1.00</i>	<i>1.00</i>
<i>20:00-21:00</i>	<i>1</i>	<i>1</i>	<i>1</i>	<i>1.00</i>	<i>1.00</i>	<i>1.00</i>
<i>21:00-22:00</i>	<i>0</i>	<i>1</i>	<i>1</i>	<i>1.00</i>	<i>1.00</i>	<i>1.00</i>
<i>22:00-23:00</i>	<i>0</i>	<i>1</i>	<i>1</i>	<i>1.00</i>	<i>1.00</i>	<i>1.00</i>
<i>23:00-24:00</i>	<i>0</i>	<i>1</i>	<i>1</i>	<i>1.00</i>	<i>1.00</i>	<i>1.00</i>

Table 9-18 Schedules for Shopping Complex- Strip Retail & Supermall Buildings (A)

<i>Strip Retail & Supermall</i>						
<i>Time Period</i>	<i>Occupancy Schedule</i>		<i>Lighting Schedule</i>	<i>Equipment Schedule</i>	<i>Elevator Schedule</i>	
	<i>Retail & Circulation</i>		<i>All Spaces</i>	<i>All Spaces</i>		
	<i>Weekdays</i>	<i>Weekends</i>	<i>7 Days/ week</i>	<i>7 Days/ week</i>	<i>Weekdays</i>	<i>Weekends</i>
00:00-01:00	0.00	0.00	0.05	0.05	0.00	0.00
01:00-02:00	0.00	0.00	0.05	0.05	0.00	0.00
02:00-03:00	0.00	0.00	0.05	0.05	0.00	0.00
03:00-04:00	0.00	0.00	0.05	0.05	0.00	0.00
04:00-05:00	0.00	0.00	0.05	0.05	0.00	0.00
05:00-06:00	0.00	0.00	0.05	0.05	0.00	0.00
06:00-07:00	0.00	0.00	0.05	0.05	0.00	0.00
07:00-08:00	0.00	0.00	0.05	0.05	0.10	0.10
08:00-09:00	0.00	0.00	0.05	0.05	0.10	0.10
09:00-10:00	0.20	0.20	0.20	0.05	0.20	0.20
10:00-11:00	0.40	0.40	0.50	0.90	0.40	0.40
11:00-12:00	0.60	0.60	0.95	0.90	0.70	0.70
12:00-13:00	0.60	0.70	0.95	0.90	0.70	0.80
13:00-14:00	0.60	0.90	0.95	0.90	0.70	0.95
14:00-15:00	0.70	0.90	0.95	0.90	0.70	0.95
15:00-16:00	0.70	0.90	0.95	0.90	0.70	0.95
16:00-17:00	0.70	0.90	0.95	0.90	0.70	0.95
17:00-18:00	0.70	0.90	0.95	0.90	0.80	0.95
18:00-19:00	0.90	0.95	0.95	0.90	0.80	0.95
19:00-20:00	0.90	0.95	0.95	0.90	0.80	0.95
20:00-21:00	0.90	0.95	0.95	0.50	0.80	0.95
21:00-22:00	0.00	0.00	0.05	0.05	0.00	0.00
22:00-23:00	0.00	0.00	0.05	0.05	0.00	0.00
23:00-24:00	0.00	0.00	0.05	0.05	0.00	0.00

Table 9-19 Schedules for Shopping Complex- Strip Retail & Supermall Buildings (A)

<i>Strip Retail & Supermall</i>				
<i>Time Period</i>	<i>HVAC Fan Schedule (On/Off)</i>	<i>External Lighting Schedule</i>	<i>Basement Ventilation</i>	<i>Basement Lighting</i>
	<i>7 Days/ week</i>	<i>7 Days/ week</i>	<i>7 Days/ week</i>	<i>7 Days/ week</i>
00:00-01:00	0	0.20	0.00	0.05
01:00-02:00	0	0.20	0.00	0.05
02:00-03:00	0	0.20	0.00	0.05
03:00-04:00	0	0.20	0.00	0.05
04:00-05:00	0	0.20	0.00	0.05
05:00-06:00	0	0.20	0.00	0.05
06:00-07:00	0	0.00	0.00	0.05
07:00-08:00	0	0.00	0.00	0.05
08:00-09:00	0	0.00	0.00	0.05
09:00-10:00	1	0.00	1.00	1.00
10:00-11:00	1	0.00	1.00	1.00
11:00-12:00	1	0.00	1.00	1.00
12:00-13:00	1	0.00	1.00	1.00
13:00-14:00	1	0.00	1.00	1.00
14:00-15:00	1	0.00	1.00	1.00
15:00-16:00	1	0.00	1.00	1.00
16:00-17:00	1	0.00	1.00	1.00
17:00-18:00	1	0.00	1.00	1.00
18:00-19:00	1	1.00	1.00	1.00
19:00-20:00	1	1.00	1.00	1.00
20:00-21:00	1	1.00	1.00	1.00
21:00-22:00	0	1.00	0.20	0.50
22:00-23:00	0	0.20	0.00	0.05
23:00-24:00	0	0.20	0.00	0.05

Table 9-20 Schedules for Assembly Buildings

Assembly								
Time Period	Occupancy Schedule	Lighting Schedule	Equipment Schedule	Elevator Schedule	HVAC Fan Schedule (On/Off)	External Lighting Schedule	Basement Ventilation	Basement Lighting
00:00-01:00	0.00	0.00	0.00	0.00	0	0.80	0.00	0.80
01:00-02:00	0.00	0.00	0.00	0.00	0	0.80	0.00	0.10
02:00-03:00	0.00	0.00	0.00	0.00	0	0.80	0.00	0.10
03:00-04:00	0.00	0.00	0.00	0.00	0	0.80	0.00	0.10
04:00-05:00	0.00	0.00	0.00	0.00	0	0.80	0.00	0.10
05:00-06:00	0.00	0.00	0.00	0.00	0	0.80	0.00	0.10
06:00-07:00	0.00	0.00	0.00	0.00	0	0.00	0.00	0.10
07:00-08:00	0.00	0.00	0.00	0.00	0	0.00	0.00	0.10
08:00-09:00	0.20	0.40	0.30	0.20	0	0.00	1.00	0.80
09:00-10:00	0.20	0.75	0.50	0.50	1	0.00	1.00	0.80
10:00-11:00	0.20	0.95	0.95	0.50	1	0.00	1.00	0.80
11:00-12:00	0.80	0.95	0.95	0.50	1	0.00	1.00	0.80
12:00-13:00	0.80	0.95	0.95	0.50	1	0.00	1.00	0.80
13:00-14:00	0.80	0.95	0.95	0.50	1	0.00	1.00	0.80
14:00-15:00	0.80	0.95	0.95	0.50	1	0.00	1.00	0.80
15:00-16:00	0.80	0.95	0.95	0.50	1	0.00	1.00	0.80
16:00-17:00	0.80	0.95	0.95	0.50	1	0.00	1.00	0.80
17:00-18:00	0.80	0.95	0.95	0.50	1	0.00	1.00	0.80
18:00-19:00	0.50	0.95	0.50	0.50	1	0.80	1.00	0.80
19:00-20:00	0.20	0.40	0.30	0.40	1	0.80	1.00	0.80
20:00-21:00	0.20	0.40	0.30	0.20	0	0.80	1.00	0.80
21:00-22:00	0.20	0.40	0.30	0.20	0	0.80	1.00	0.80
22:00-23:00	0.10	0.10	0.00	0.00	0	0.80	1.00	0.80
23:00-24:00	0.10	0.10	0.00	0.00	0	0.80	0.00	0.80

Table 9-21 Schedules for Business - Office Buildings

<i>Business - Office</i>							
<i>Time Period</i>	<i>HVAC Fan Schedule (On/Off)</i>		<i>External Lighting Schedule</i>	<i>Basement Ventilation</i>		<i>Basement Lighting</i>	
	<i>Daytime Business</i>	<i>24 Hour Business</i>	<i>7 Days/ week</i>	<i>Daytime Business</i>	<i>24 Hour Business</i>	<i>Daytime Business</i>	<i>24 Hour Business</i>
00:00-01:00	0	1	0.80	0.00	1.00	0.05	1.00
01:00-02:00	0	1	0.80	0.00	1.00	0.05	1.00
02:00-03:00	0	1	0.80	0.00	1.00	0.05	1.00
03:00-04:00	0	1	0.80	0.00	1.00	0.05	1.00
04:00-05:00	0	1	0.80	0.00	1.00	0.05	1.00
05:00-06:00	0	1	0.80	0.00	1.00	0.05	1.00
06:00-07:00	0	1	0.00	0.00	1.00	0.05	1.00
07:00-08:00	1	1	0.00	0.00	1.00	0.05	1.00
08:00-09:00	1	1	0.00	1.00	1.00	1.00	1.00
09:00-10:00	1	1	0.00	1.00	1.00	1.00	1.00
10:00-11:00	1	1	0.00	1.00	1.00	1.00	1.00
11:00-12:00	1	1	0.00	1.00	1.00	1.00	1.00
12:00-13:00	1	1	0.00	1.00	1.00	1.00	1.00
13:00-14:00	1	1	0.00	1.00	1.00	1.00	1.00
14:00-15:00	1	1	0.00	1.00	1.00	1.00	1.00
15:00-16:00	1	1	0.00	1.00	1.00	1.00	1.00
16:00-17:00	1	1	0.00	1.00	1.00	1.00	1.00
17:00-18:00	1	1	0.00	1.00	1.00	1.00	1.00
18:00-19:00	1	1	0.80	1.00	1.00	1.00	1.00
19:00-20:00	1	1	0.80	1.00	1.00	1.00	1.00
20:00-21:00	1	1	0.80	1.00	1.00	1.00	1.00
21:00-22:00	1	1	0.80	0.00	1.00	0.05	1.00
22:00-23:00	0	1	0.80	0.00	1.00	0.05	1.00
23:00-24:00	0	1	0.80	0.00	1.00	0.05	1.00

APPENDICES

10. APPENDIX A: DEFAULT VALUES FOR TYPICAL CONSTRUCTIONS

10.1 Procedure for Determining Fenestration Product U-factor and Solar Heat Gain Coefficient

§4.2.1.1 and §4.2.1.2 require that U-factors and solar heat gain coefficients (SHGC) be determined for the overall fenestration product (including the sash and frame) in accordance with ISO 15099. The building envelope trade-off option in § 4.3.5 requires the use of visible light transmittance (VLT).

In several cases, ISO 15099 suggests that individual national standards will need to be more specific and in other cases the ISO document gives users the choice of two options. This section clarifies these specific issues as they are to be implemented for this code:

- (a) § 4.1 of ISO 15099: For calculating the overall U-factor, ISO 15099 offers a choice between the linear thermal transmittance (4.1.2) and the area weighted method (4.1.3). The area weighted method (4.1.3) shall be used.
- (b) § 4.2.2 of ISO 15099: Frame and divider SHGC's shall be calculated in accordance with § 4.2.2. The alternate approach in § 8.6 shall not be used.
- (c) § 6.4 of ISO 15099 refers the issue of material properties to national standards. Material conductivities and emissivity shall be determined in accordance with Indian standards.
- (d) § 7 of ISO 15099 on shading systems is currently excluded.
- (e) § 8.2 of ISO 15099 addresses environmental conditions. The following are defined for India:

For U-factor calculations:

$$T_{in} = 24 \text{ }^{\circ}\text{C}$$

$$T_{out} = 32 \text{ }^{\circ}\text{C}$$

$$V = 3.35 \text{ m/s}$$

$$T_{rm,out} = T_{out}$$

$$T_{rm,in} = T_{in}$$

$$I_s = 0 \text{ W/m}^2$$

For SHGC calculations:

$$T_{in} = 24 \text{ }^{\circ}\text{C}$$

$$T_{out} = 32 \text{ }^{\circ}\text{C}$$

$$V = 2.75 \text{ m/s}$$

$$T_{rm,out} = T_{out}$$

$$T_{rm,in} = T_{in}$$

$I_s=783 \text{ W/m}^2$

- (f) § 8.3 of ISO 15099 addresses convective film coefficients on the interior and exterior of the window product. In § 8.3.1 of ISO 15099, simulations shall use the heat transfer coefficient based on the center of glass temperature and the entire window height; this film coefficient shall be used on all indoor surfaces, including frame sections. In § 8.3.2 of ISO 15099, the formula from this section shall be applied to all outdoor exposed surfaces.
- (g) § 8.4.2 of ISO 15099 presents two possible approaches for incorporating the impacts of self-viewing surfaces on interior radiative heat transfer calculations. Products shall use the method in § 8.4.2.1 of ISO 15099 (Two-Dimensional Element to Element View Factor Based Radiation Heat Transfer Calculation). The alternate approach in § 8.4.3 of ISO 15099 shall not be used.

10.2 Default U-factors and Solar Heat Gain Coefficients for Unrated Fenestration Products

All fenestration with U-factors, SHGC, or visible light transmittance determined, certified, and labeled in accordance ISO 15099 shall be assigned those values.

10.2.1 Unrated Vertical Fenestration.

Unlabeled vertical fenestration, both operable and fixed, shall be assigned the U-factors, SHGCs, and visible light transmittances in Table 10-1.

Table 10-1 Defaults for Unrated Vertical Fenestration (Overall Assembly including the Sash and Frame)

Frame Type	Glazing Type	U-Factor (W/m ² .K)
All frame types	Single Glazing	7.1
Wood, vinyl, or fiberglass frame or metal frame with thermal break	Double Glazing	3.4
Metal and other frame type	Double Glazing	5.1

10.2.2 Unrated Sloped Glazing and Skylights

Unrated sloped glazing and skylights, both operable and fixed, shall be assigned the SHGCs and visible light transmittances in Table 10-1. To determine the default U-factor for unrated sloped glazing and skylights without a curb, multiply the values in Table 10-1 by 1.2. To determine the default U-factor for unrated skylights on a curb, multiply the values in Table 10-1 by 1.6.

10.3 Typical Roof Constructions

For calculating the overall U-factor of a typical roof construction, the U-factors from the typical wall construction type and effective U-factor for insulation shall be combined according to the following equation:

$$U_{TotalRoof} = \frac{1}{\frac{1}{U_{TypicalRoof}} + \frac{1}{U_{TypicalInsulation}}}$$

where

$U_{TotalRoof}$ Total U-factor of the roof with insulation

$U_{TypicalRoof}$ U-factor of the roof

$U_{TypicalInsulation}$ U-factor of the effective insulation

10.4 Typical Wall Constructions

For calculating the overall U-factor of a typical wall construction, the U-factors from the typical wall construction type and effective U-factor for insulation shall be combined according to the following equation:

$$U_{TotalWall} = \frac{1}{\frac{1}{U_{TypicalWall}} + \frac{1}{U_{TypicalInsulation}}}$$

where

$U_{TotalWall}$ Total U-factor of the wall with insulation

$U_{TypicalWall}$ U-factor of the wall

$U_{TypicalInsulation}$ U-factor of the effective insulation

Table 10-2 Typical Thermal Properties of Common Building and Insulating Materials⁴

Description	Density	Conductivity ^b k,	Resistance R,	Specific Heat,
	kg/m ³	W/(m·K)	(m ² ·K)/W	kJ/(kg·K)
Building Board and Siding				
<i>Board</i>				
Asbestos/cement board	1900	0.57	-	1
Cement board	1150	0.25	-	0.84
Fiber/cement board	1400	0.25	-	0.84
	1000	0.19	-	0.84
	400	0.07	-	1.88
	300	0.06	-	1.88
Gypsum or plaster board	640	0.16	-	1.15
Oriented strand board (OSB) 9 to 11 mm	650	-	0.11	1.88
..... 12.7 mm	650	-	0.12	1.88
Plywood (douglas fir)..... 12.7 mm	460	-	0.14	1.88
 15.9 mm	540	-	0.15
Plywood/wood panels 19.0 mm	550	-	0.19	1.88
Vegetable fiber board				-
Sheathing, regular density ^e 12.7 mm	290	-	0.23	1.3
intermediate density ^e 12.7 mm	350	-	0.19	1.3
Nail-base sheathing ^e 12.7 mm	400	-	0.19	1.3
Shingle backer..... 9.5 mm	290	-	0.17	1.3
Sound deadening board..... 12.7 mm	240	-	0.24	1.26
Tile and lay-in panels, plain or acoustic	290	0.058	-	0.59
Laminated paperboard	480	0.072	-	1.38
Homogeneous board from repulped paper	480	0.072	-	1.17
Hardboard ^e				
..... <i>medium density</i>	800	0.105	-	1.3
..... <i>high density, service-tempered</i>	880	0.12	-	1.34
..... <i>grade and service grade</i>				
..... <i>high density, standard-tempered grade</i>	1010	0.144	-	1.34
Particleboard ^e				

⁴ 2009 ASHRAE Handbook - Fundamentals

<i>low density</i>	590	0.102	-	1.3
<i>medium density</i>	800	0.135	-	1.3
<i>high density</i>	1000	0.18	-	-
underlayment..... 15.9 mm	640	-	1.22	1.21
Waferboard	700	0.072	-	1.88
<i>Shingles</i>				
Asbestos/cement	1900	-	0.37	-
Wood, 400 mm, 190 mm exposure	-	-	0.015	1.3
Wood, double, 400 mm, 300 mm exposure	-	-	0.21	1.17
Wood, plus ins. backer board... 8 mm	-	-	0.25	1.3
Siding				-
Asbestos/cement, lapped..... 6.4 mm	-	-	0.037	1.01
Asphalt roll siding	-	-	0.026	1.47
<i>Siding</i>				
Asphalt insulating siding (12.7 mm bed).....	-	-	0.26	1.47
Hardboard siding..... 11 mm	-	-	0.12	1.17
Wood, drop, 200 mm..... 25 mm	-	-	0.14	1.17
Wood, bevel				
<i>200 mm, lapped 13 mm</i>	-	-	0.14	1.17
<i>250 mm, lapped 19 mm</i>	-	-	0.18	1.17
<i>Wood, plywood, lapped 9.5 mm</i>	-	-	0.1	1.22
Aluminum, steel, or vinyl, ^{l,k} over sheathing				-
hollow-backed	-	-	0.11	1.22
insulating-board-backed				-
9.5 mm	-	-	0.32	1.34
foil-backed 9.5 mm	-	-	0.52	-
Architectural (soda-lime float) glass.....	2500	1	-	0.84
Building Membrane				
Vapor-permeable felt	-	-	0.011	-
Vapor: seal, 2 layers of mopped 0.73 kg/m ² felt	-	-	0.21	-
Vapor: seal, plastic film.....	-	-	Negligible	-
Finish Flooring Materials				
Carpet and rebounded urethane pad..... 19 mm	110	-	0.42	-
Carpet and rubber pad (one-piece)..... 9.5 mm	320	-	0.12	-
Pile carpet with rubber pad 9.5 to 12.7 mm	290	-	0.28	-
Linoleum/cork tile..... 6.4 mm	465	-	0.09	-
PVC/Rubber floor covering	-	0.4	-	-

Rubber tile..... 25 mm	1900	-	0.06	-
Terrazzo..... 25 mm	-	-	0.014	0.8
Insulating Materials				
<i>Blanket and batt^{c,d}</i>				
Glass-fiber batts 85 to 90 mm	10 to 14	0.043	-	0.84
50 mm	8 to 13	0.045 to 0.048	-	0.84
Mineral fiber 140 mm	30	0.036	-	0.84
Mineral wool, felted	16 to 48	0.04	-	-
	65 to 130	0.035	-	-
Slag wool	50 to 190	0.038	-	-
	255	0.04	-	-
	305	0.043	-	-
	350	0.048	-	-
	400	0.05	-	-
<i>Board and slabs</i>				
Cellular glass	130	0.048	-	0.75
Cement fiber slabs, shredded wood	400 to 430	0.072 to 0.076	-	-
with Portland cement binder			-	
with magnesia oxysulfide binder	350	0.082	-	1.3
Glass fiber board	160	0.032 to 0.040	-	0.84
Expanded rubber (rigid)	70	0.032	-	1.67
Expanded polystyrene extruded (smooth skin)	25 to 40	0.022 to 0.030	-	1.47
Expanded polystyrene, molded beads	15 to 25	0.032 to 0.039	-	1.47
Mineral fiberboard, wet felted	160	0.038	-	0.84
core or roof insulation	255 to 270	0.049	-	-
acoustical tile ^g	290	0.05	-	0.8
	335	0.053	-	-
wet-molded, acoustical tile	370	0.061	-	0.59
Perlite board	160	0.052	-	-
Polyisocyanurate, aged				
unfaced	25 to 35	0.020 to 0.027	-	-
with facers	65	0.019	-	1.47
Phenolic foam board with facers, aged	65	0.019	-	-

<i>Loose fill</i>				
Cellulosic (milled paper or wood pulp)	35 to 50	0.039 to 0.045	-	1.38
Perlite, expanded	30 to 65	0.039 to 0.046	-	1.09
	65 to 120	0.045 to 0.052	-	-
	120 to 180	0.052 to 0.061	-	-
Mineral fiber (rock, slag, or glass) ^d				
..... <i>approx. 95 to 130 mm</i>	10 to 30	-	1.92	0.71
..... <i>approx. 170 to 220 mm</i>	11 to 30	-	3.33	-
..... <i>approx. 190 to 250 mm</i>	12 to 30	-	3.85	-
..... <i>approx. 260 to 350 mm</i>	13 to 30	-	5.26	-
..... <i>90 mm (closed sidewall application)</i>	30 to 55	-	2.1 to 2.5	-
Vermiculite, exfoliated	110 to 130	0.068	-	1.34
	64 to 96	0.063	-	-
<i>Spray-applied</i>				
Cellulosic fiber.....	55 to 95	0.042 to 0.049	-	-
Glass fiber	55 to 70	0.038 to 0.039	-	-
Polyurethane foam (low density)	6 to 8	0.042	-	1.47
	40	0.026	-	1.47
<i>aged and dry..... 40 mm</i>	30	-	1.6	1.47
..... <i>50 mm</i>	55	-	1.92	1.47
..... <i>120 mm</i>	30	-	3.69	-
Ureaformaldehyde foam, dry	8 to 20	0.030 to 0.032	-	-
Metals				
Roofing				
Asbestos/cement shingles	1120	-	0.037	1
Asphalt (bitumen with inert fill)	1600	0.43	-	-
	1900	0.58	-	-
	2300	1.15	-	-
Asphalt roll roofing.....	920	-	0.027	1.51
Asphalt shingles	920	-	0.078	1.26
Built-up roofing .	920	-	0.059	1.47
Mastic asphalt (heavy, 20% grit)	950	0.19	-	-
Reed thatch.....	270	0.09	-	-

Roofing felt	2250	1.2	-	-
Slate..... 13 mm	-	-	0.009	1.26
Straw thatch	240	0.07	-	-
Wood shingles, plain and plastic-film-faced...	-	-	0.166	1.3
Plastering Materials				
Cement plaster, sand aggregate	1860	0.72	-	0.84
Sand aggregate				
10 mm	-	-	0.013	0.84
20 mm	-	-	0.026	0.84
Gypsum plaster	1120	0.38	-	-
	1280	0.46	-	-
Lightweight aggregate				
..... 13 mm	720	-	0.056	-
16 mm	720	-	0.066	-
on metal lath..... 19 mm	-	-	0.083	-
Perlite aggregate.....	720	0.22	-	1.34
Sand aggregate	1680	0.81	-	0.84
.....				
on metal lath.....	-	-	0.023	-
19 mm				
Vermiculite aggregate	480	0.14	-	-
.....				
.....	600	0.2	-	-
.....				
.....	720	0.25	-	-
.....				
.....	840	0.26	-	-
.....				
.....	960	0.3	-	-
.....				
Perlite plaster	400	0.08	-	-
.....				
.....	600	0.19	-	-
.....				
Pulpboard or paper plaster	600	0.07	-	-
.....				
Sand/cement plaster, conditioned	1560	0.63	-	-
.....				
Sand/cement/lime plaster, conditioned	1440	0.48	-	-
.....				
Sand/gypsum (3:1) plaster, conditioned.....	1550	0.65	-	-
Masonry Materials				
<i>Masonry units</i>				

Brick, fired clay.....	2400	1.21 to 1.47	-	-
.....	2240	1.07 to 1.30	-	-
.....	2080	0.92 to 1.12	-	-
.....	1920	0.81 to 0.98	-	0.8
.....	1760	0.71 to 0.85	-	-
.....	1600	0.61 to 0.74	-	-
.....	1440	0.52 to 0.62	-	-
.....	1280	0.43 to 0.53	-	-
.....	1120	0.36 to 0.45	-	-
Clay tile, hollow.....				
1 cell deep	-	-	0.14	0.88
75 mm				
.....	-	-	0.2	-
100 mm				
2 cells deep.....	-	-	0.27	-
150 mm				
.....	-	-	0.33	-
200 mm				
.....	-	-	0.39	-
250 mm				
3 cells deep.....	-	-	0.44	-
300 mm				
Lightweight brick.....	800	0.2	-	-
.....	770	0.22	-	-
.....				
Concrete blocks ^{h,i}				-
Limestone aggregate				-
~200 mm, 16.3 kg, 2200 kg/m ³ concrete, 2 cores ..	-	-	-	-
with perlite-filled cores	-	-	0.37	-
~300 mm, 25 kg, 2200 kg/m ³ concrete, 2 cores	-	-	-	-
with perlite-filled cores	-	-	0.65	-
Normal-weight aggregate (sand and gravel)				
~200 mm, 16 kg, 2100 kg/m ³	-	-	0.20 to 0.17	0.92
concrete, 2 or 3 cores				
with perlite-filled cores	-	-	0.35	-

with vermiculite-filled cores	-	-	0.34 to 0.24	-
~300 mm, 22.7 kg, 2000 kg/m ³ concrete, 2 cores ..	-	-	0.217	0.92
Medium-weight aggregate (combinations of normal				
and lightweight aggregate)				
~200 mm, 13 kg, 1550 to 1800 kg/m ³				
concrete, 2 or 3 cores	-	-	0.30 to 0.22	-
with perlite-filled cores	-	-	0.65 to 0.41	-
with vermiculite-filled cores	-	-	0.58	-
with molded-EPS-filled (beads) cores	-	-	0.56	-
with molded EPS inserts in cores.....	-	-	0.47	-
Low-mass aggregate (expanded shale, clay, slate or				
slag, pumice)				
~150 mm, 7 1/2 kg, 1400 kg/m ²				
concrete, 2 or 3 cores	-	-	0.34 to 0.29	-
with perlite-filled cores	-	-	0.74	-
with vermiculite-filled cores	-	-	0.53	-
200 mm, 8 to 10 kg, 1150 to 1380 kg/m ² concrete	-	-	0.56 to 0.33	0.88
with perlite-filled cores	-	-	1.20 to 0.77	-
with vermiculite-filled cores	-	-	0.93 to 0.69	-
with molded-EPS-filled (beads) cores	-	-	0.85	-
with UF foam-filled cores	-	-	0.79	-
with molded EPS inserts in cores.....	-	-	0.62	-
300 mm, 16 kg, 1400 kg/m ³ ,				-
concrete, 2 or 3 cores	-	-	0.46 to 0.40	-
with perlite-filled cores	-	-	1.6 to 1.1	-
with vermiculite-filled cores	-	-	1	-
Stone, lime, or sand.....	2800	10.4	-	-
Quartzitic and sandstone	2560	6.2	-	-
.....	2240	3.46	-	-
.....	1920	1.88	-	0.88

Calclitic, dolomitic, limestone, marble, and granite	2880	4.33	-	-
.....	2560	3.17	-	-
.....	2240	2.31	-	-
.....	1920	1.59	-	0.88
.....	1600	1.15	-	-
Gypsum partition tile				
75 by 300 by 760 mm, solid.....	-	-	0.222	0.79
4 cells	-	-	0.238	-
100 by 300 by 760 mm, 3 cells	-	-	0.294	-
Limestone.....	2400	0.57	-	0.84
.....	2600	0.93	-	0.84
<i>Concretes</i>				
Sand and gravel or stone aggregate concretes (concretes with >50% quartz or quartzite sand have conductivities in higher end of range).....	2400	1.4 to 2.9	-	-
.....	2240	1.3 to 2.6	-	0.80 to 1.00
.....	2080	1.0 to 1.9	-	-
Low-mass aggregate or limestone concretes.....	1920	0.9 to 1.3	-	-
Expanded shale, clay, or slate; expanded slags; cinders; pumice (with density up to 1600 kg/m ³); scoria (sanded concretes have conductivities in higher end of range)	1600	0.68 to 0.89	-	0.84
.....	1280	0.48 to 0.59	-	0.84
.....	960	0.30 to 0.36	-	-
.....	640	0.18	-	-
Gypsum/fiber concrete (87.5% gypsum, 12.5% wood chips)	800	0.24	-	0.84
Cement/lime, mortar, and stucco	1920	1.4	-	-

..... .	1600	0.97	-	-
..... .	1280	0.65	-	-
Perlite, vermiculite, and polystyrene beads	800	0.26 to 0.27	-	-
..... .	640	0.20 to 0.22	-	0.63 to 0.96
..... .	480	0.16	-	-
..... .	320	0.12	-	-
Foam concretes	1920	0.75	-	-
..... .	1600	0.6	-	-
..... .	1280	0.44	-	-
..... .	1120	0.36	-	-
Foam concretes and cellular concretes	960	0.3	-	-
..... .	640	0.2	-	-
..... .	320	0.12	-	-
Aerated concrete (oven-dried)	430 to 800	0.2	-	0.84
Polystyrene concrete (oven-dried)	255 to 800	0.37	-	0.84
Polymer concrete	1950	1.64	-	-
..... .	2200	1.03	-	-
Polymer cement	1870	0.78	-	-
Slag concrete.....	960	0.22	-	-
..... .	1280	0.32	-	-
..... .	1600	0.43	-	-
..... .	2000	1.23	-	-
Woods (12% moisture content)				
<i>Hardwoods</i>	-	-	-	1.63
Oak.....	660 to 750	0.16 to 0.18	-	-
Birch.....	680 to 725	0.17 to 0.18	-	-
Maple	635 to 700	0.16 to 0.17	-	-

Ash	615 to 670	0.15 to 0.16	-	-
<i>Softwoods</i>	-	-	-	1.63
Southern pine	570 to 660	0.14 to 0.16	-	-
Southern yellow pine	500	0.13	-	-
Eastern white pine.....	400	0.1	-	-
Douglas fir/larch	535 to 580	0.14 to 0.15	-	-
Southern cypress	500 to 515	0.13	-	-
Hem/fir, spruce/pine/fir.....	390 to 500	0.11 to 0.13	-	-
Spruce	400	0.09	-	-
Western red cedar.....	350	0.09	-	-
West coast woods, cedars.....	350 to 500	0.10 to 0.13	-	-
Eastern white cedar	360	0.1	-	-
California redwood	390 to 450	0.11 to 0.12	-	-
Pine (oven- dried).....	370	0.092	-	1.88
.	395	0.1	-	1.88

11. APPENDIX B: CLIMATE ZONE MAP OF INDIA

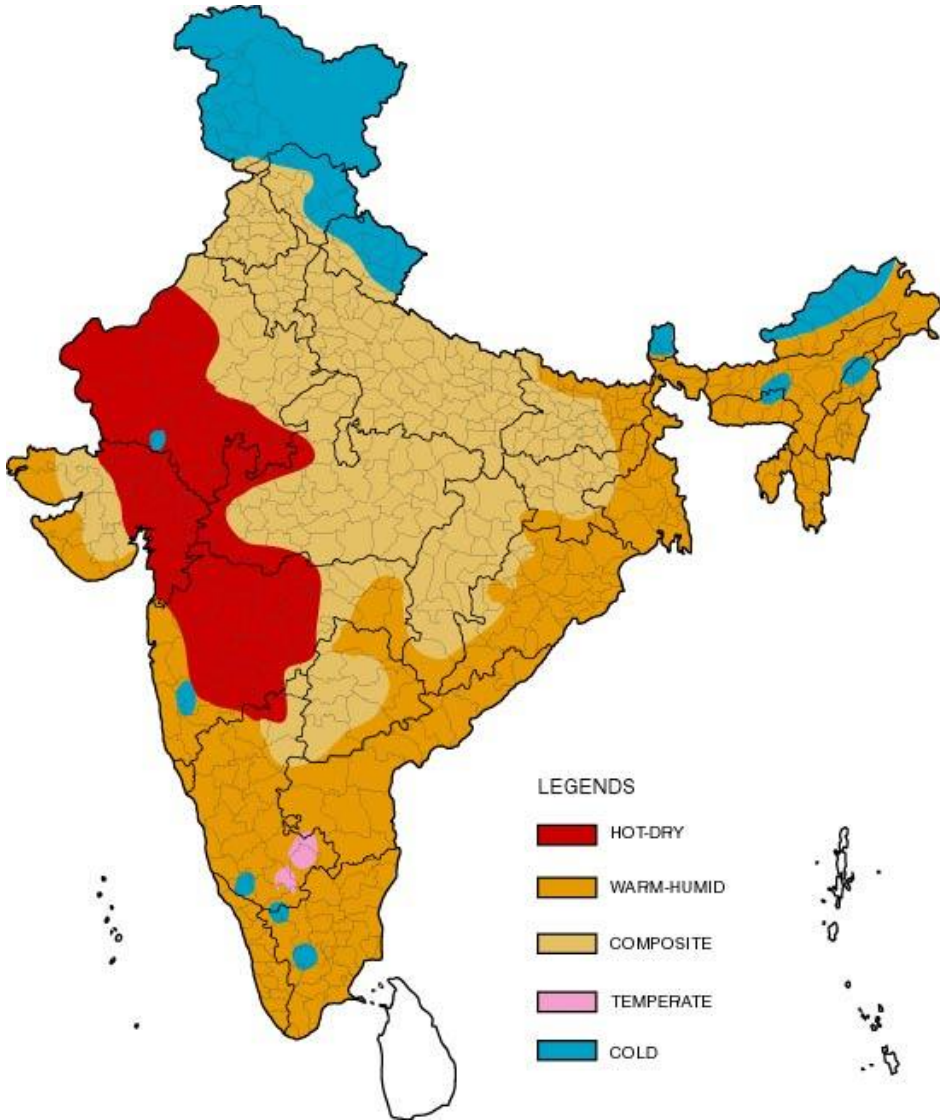

Table 11-1 Climate Zone for Major Indian Cities

<i>City</i>	<i>Climate Type</i>	<i>City</i>	<i>Climate Type</i>
<i>Ahmedabad</i>	<i>Hot & Dry</i>	<i>Kurnool</i>	<i>Warm & Humid</i>
<i>Allahabad</i>	<i>Composite</i>	<i>Leh</i>	<i>Cold</i>
<i>Amritsar</i>	<i>Composite</i>	<i>Lucknow</i>	<i>Composite</i>
<i>Aurangabad</i>	<i>Hot & Dry</i>	<i>Ludhiana</i>	<i>Composite</i>
<i>Bangalore</i>	<i>Temperate</i>	<i>Chennai</i>	<i>Warm & Humid</i>
<i>Barmer</i>	<i>Hot & Dry</i>	<i>Manali</i>	<i>Cold</i>
<i>Belgaum</i>	<i>Warm & Humid</i>	<i>Mangalore</i>	<i>Warm & Humid</i>
<i>Bhagalpur</i>	<i>Warm & Humid</i>	<i>Mumbai</i>	<i>Warm & Humid</i>
<i>Bhopal</i>	<i>Composite</i>	<i>Nagpur</i>	<i>Composite</i>
<i>Bhubaneshwar</i>	<i>Warm & Humid</i>	<i>Nellore</i>	<i>Warm & Humid</i>
<i>Bikaner</i>	<i>Hot & Dry</i>	<i>New Delhi</i>	<i>Composite</i>
<i>Chandigarh</i>	<i>Composite</i>	<i>Panjim</i>	<i>Warm & Humid</i>
<i>Chitradurga</i>	<i>Warm & Humid</i>	<i>Patna</i>	<i>Composite</i>
<i>Dehradun</i>	<i>Composite</i>	<i>Pune</i>	<i>Warm & Humid</i>
<i>Dibrugarh</i>	<i>Warm & Humid</i>	<i>Raipur</i>	<i>Composite</i>
<i>Guwahati</i>	<i>Warm & Humid</i>	<i>Rajkot</i>	<i>Composite</i>
<i>Gorakhpur</i>	<i>Composite</i>	<i>Ramgundam</i>	<i>Warm & Humid</i>
<i>Gwalior</i>	<i>Composite</i>	<i>Ranchi</i>	<i>Composite</i>
<i>Hissar</i>	<i>Composite</i>	<i>Ratnagiri</i>	<i>Warm & Humid</i>
<i>Hyderabad</i>	<i>Composite</i>	<i>Raxaul</i>	<i>Warm & Humid</i>
<i>Imphal</i>	<i>Warm & Humid</i>	<i>Saharanpur</i>	<i>Composite</i>
<i>Indore</i>	<i>Composite</i>	<i>Shillong</i>	<i>Cold</i>
<i>Jabalpur</i>	<i>Composite</i>	<i>Sholapur</i>	<i>Hot & Dry</i>
<i>Jagdelpur</i>	<i>Warm & Humid</i>	<i>Srinagar</i>	<i>Cold</i>
<i>Jaipur</i>	<i>Composite</i>	<i>Sundernagar</i>	<i>Cold</i>
<i>Jaisalmer</i>	<i>Hot & Dry</i>	<i>Surat</i>	<i>Hot & Dry</i>
<i>Jalandhar</i>	<i>Composite</i>	<i>Tezpur</i>	<i>Warm & Humid</i>
<i>Jamnagar</i>	<i>Warm & Humid</i>	<i>Tiruchirappalli</i>	<i>Warm & Humid</i>
<i>Jodhpur</i>	<i>Hot & Dry</i>	<i>Trivandrum</i>	<i>Warm & Humid</i>
<i>Jorhat</i>	<i>Warm & Humid</i>	<i>Tuticorin</i>	<i>Warm & Humid</i>
<i>Kochi</i>	<i>Warm & Humid</i>	<i>Udhagamandalam</i>	<i>Cold</i>
<i>Kolkata</i>	<i>Warm & Humid</i>	<i>Vadodara</i>	<i>Hot & Dry</i>
<i>Kota</i>	<i>Hot & Dry</i>	<i>Veraval</i>	<i>Warm & Humid</i>
<i>Kullu</i>	<i>Cold</i>	<i>Vishakhapatnam</i>	<i>Warm & Humid</i>

12. APPENDIX C: AIR-SIDE ECONOMIZER ACCEPTANCE PROCEDURES

12.1 Construction Inspection

Prior to Performance Testing, verify and document the following:

- (a) System controls are wired correctly to ensure economizer is fully integrated (i.e. economizer will operate when mechanical cooling is enabled).
- (b) Economizer lockout control sensor location is adequate (open to air but not exposed to direct sunlight nor in an enclosure; away from sources of building exhaust; at least 8 meters away from cooling towers).
- (c) System is provided with barometric relief, relief fan or return fan to control building pressure.

12.2 Equipment Testing

Step 1: Simulate a cooling load and enable the economizer by adjusting the lockout control set point. Verify and document the following:

- (a) Economizer damper modulates opens to 100% outside air.
- (b) Return air damper modulates closed and is completely closed when economizer damper is 100% open.
- (c) Economizer damper is 100% open before mechanical cooling is enabled.
- (d) Relief fan or return fan (if applicable) is operating or barometric relief dampers freely swing open.

Step 2: Continue from Step 1 and disable the economizer by adjusting the lockout control set point. Verify and document the following:

- (a) Economizer damper closes to minimum ventilation position.
- (b) Return air damper opens to at or near 100%.
- (c) Relief fan (if applicable) shuts off or barometric relief dampers close. Return fan (if applicable) may still operate even when economizer is disabled.

13. APPENDIX D: COMPLIANCE FORMS

DRAFT

Envelope Summary

Energy Conservation Building Code 2017 Compliance Forms

Project Info	Project Address	Date
		For Building Department Use
	Project Built-up Area [m ²]	
	Project Above-grade Area [m ²]	
	Project Conditioned Area [m ²]	
	Applicant Name and Address	
Project Climatic Zone		

Building Classification	<input type="checkbox"/> Hospitality	<input type="checkbox"/> Business
	<input type="checkbox"/> Health Care	<input type="checkbox"/> Educational
	<input type="checkbox"/> Assembly	<input type="checkbox"/> Shopping Complex

Project Description	<input type="checkbox"/> New Building	<input type="checkbox"/> Addition	<input type="checkbox"/> Alteration
	<input type="checkbox"/> Self-occupied	<input type="checkbox"/> Core and Shell	<input type="checkbox"/> Mixed-Use
Compliance is sought for Energy efficiency level	<input type="radio"/> ECBC Compliant	<input type="radio"/> ECBC+ Compliant	<input type="radio"/> SuperECBC Compliant
EPI Ratio			

Compliance Approach	Prescriptive Method	Whole Building Performance Method	Building Trade-off Method-Envelope Compliance
---------------------	---------------------	-----------------------------------	---

Building Envelope			
Vertical Fenestration Area Calculation	Total Vertical Fenestration Area (rough opening)	/	Gross Exterior Wall Area
			X 100 = % Window to Wall Ratio (WWR)
Skylight Calculation Area	Total Skylight Area (rough opening)	/	Gross Exterior Wall Area
			times 100 equals % Skylight to roof ratio (SRR)
		÷	X 100 =

Opaque Assembly		
Wall (Minimum Insulation U-factor)		
Roof (Minimum Insulation U-factor)		
Cool Roof		
Solar Reflectance		
Emittance		
Wall Assembly		
Material	R-value	Assembly U-Factor

Daylighting Summary	
% above-grade floor area meeting the UDI requirement for 90% of the potential daylight time in a year	
Fenestration	
Vertical	
Maximum U-factor	
Maximum SHGC (or SC)	
Minimum VLT	
Overhang / Sides / Box Frame Projection (yes or no)	
<i>If yes, enter Projection Factor for each orientation and effective SHGC</i>	
Skylight	
Maximum U-factor	
Maximum SHGC (or SC)	

DRAFT

Envelope Checklist

Energy Conservation Building Code 2017 Compliance Forms

Project Address		Date	
-----------------	--	------	--

Applicability			Code Section	Component	Information Required	Location on Plans	Building Department Notes
Yes	No	N/A					
Mandatory Provisions (Section 4.2)							
			4.2.1	Fenestration rating			
			4.2.1.1	U-factor	Specify reference standard		
			4.2.1.2	SHGC	Specify reference standard		
			4.2.2	Opaque U-factors	Specify reference standard		
			4.2.3	Daylighting	Specify simulation approach or prescriptive		
			4.2.4	Building envelope sealing	Indicate sealing, caulking, gasketing, and weatherstripping		

Prescriptive Compliance Option (Section 4.3)							
			4.2.5	Roofs	Specify implemented U factor		
			4.2.6	Opaque External Wall	Specify implemented U factor		
			4.3.1	Vertical fenestration	(1) Indicate U-factors on fenestration schedule. Indicate if values are rated or default. If values are default, then specify frame type, glazing layers, gapwidth, low-e. (2) Indicate SHGC or SC on fenestration schedule. Indicate if values are rated or default. (3) Indicate VLT of fenestration schedule. Indicate if values are rated or default. (4) Indicate if overhangs or side fins or box-frame projection are used for compliance purposes. If so, provide projection factor calculation and equivalent SHGC calculation		
			4.3.2	fenestration U factor exemption	Specify if applicable, specify unconditioned space percentage, and specify incorporated specifications		
			4.3.2	Skylights	(1) Indicate U-factors on fenestration schedule. Indicate if values are rated or default. If values are default, then specify frame type, glazing layers, gap width, low-e. (2) Indicate SHGC or SC on fenestration schedule. Indicate if values are rated or default.		
			4.3.3.1	Vegetative cool roof	Specify the solar reflectance, emittance, and reference standards		

Building Envelope Trade-Off Option (Section 4.3.4)							
					Provide calculations		

Comfort System and Control Summary

Energy Conservation Building Code 2017 Compliance Forms

Project Info	Project Address:	Date
	Project Built-up Area (sq.m):	For Building Department Use
	Project Above-grade area (sq.m):	
	Project Conditioned Area (sq.m):	
	Applicant Name and Address:	
	Project Climatic Zone:	

Project Description	
Briefly describe comfort system type and features.	Natural ventilation, mechanical Ventilation, Low energy comfort system, heating and cooling mechanical equipment. percentage area distribution for the installed system, and related information

Compliance Option	System efficiency	Prescriptive Method	Whole Building Performance Method
-------------------	-------------------	---------------------	-----------------------------------

Equipment Schedules	The following information is required to be incorporated with the mechanical equipment schedules on the plans. For projects without plans, fill in the required information below.
---------------------	--

Cooling Equipment Schedule								
Equip. ID	Brand Name	Model No.	Capacity kW	Testing Standards	OSA CFM or Economizer?	COP	IPLV	Location

Heating Equipment Schedule								
Equip. ID	Brand Name	Model No.	Capacity kW	Testing Standards	OSA CFM or Economizer?	Input kW	Output kW	Efficiency

Fan Equipment Schedule							
Equipment ID	Brand Name	Model No.	Testing Standards	SP	Efficiency	Flow Control	Location of Service

DRAFT

Comfort System & Controls Checklist

Energy Conservation Building Code 2017 Compliance Forms

Project Address				Date			
The following information is necessary to check a building permit application for compliance with the mechanical requirements in the Energy Conservation Building Code.							
Applicability			Code Section	Component	Information Required	Location on Plans	Building Department Notes
Yes	No	N/A					
Comfort Systems and Control							
Mandatory Provisions (Section 5.2)							
			5.2.1	Ventilation	Indicate all habitable spaces are ventilated with outdoor air in accordance with § 5.2.1 and guidelines specified in NBC		
			5.2.2	Minimum Space Conditioning Equipment Efficiencies	Provide equipment schedule with type, capacity, efficiency		
			5.2.3	Controls			
			5.2.3.1	Timeclock	Indicate thermostat with night setback, 3 different day types per week, and 2-hour manual override, capable of retaining programming and time setting during loss of power for a period of at least 10 hours		
			5.2.3.2	Temperature Controls	Indicate temperature control with 3°C deadband minimum if the system provides both heating and cooling.		
					Indicate thermostats are interlocked to prevent simultaneous heating and cooling, where separate heating and cooling systems are there		
					Indicate separate thermostat control for space types mentioned in § 5.2.3.2.(c)		
			5.2.2.3	Occupancy Controls	Indicate occupancy controls for space types mentioned in § 5.2.3.3		
			5.2.2.4	Fan Controls	Indicate two-speed motor, pony motor, or variable speed drive to control the fans and controls shall be capable to reduce the fan speed to at least two third of installed fan power		
			5.2.2.5	Dampers	Indicate all air supply and exhaust equipment's having VFD shall have dampers that automatically close upon the situations mentioned in § 5.2.3.5		
			5.2.4	Additional Controls for ECBC+ Building			
			5.2.4.1	Centralized Demand Shed Controls	Indicate the building has a Building Management System, with all Mechanical cooling and heating systems having PLC to the zone level shall have the control capabilities mentioned in § 5.2.4.1		
			5.2.4.2	Supply Air temperature reset	Indicate multi zone mechanical cooling and heating systems shall have controls to automatically reset supply air temperature in response to building loads or outdoor air temperature by at least 25% of the difference between design supply air temperature and the design room air temperature.		
			5.2.4.3	Chilled Water Temperature	Indicate chilled water systems exceeding 350 kW shall have controls to automatically reset supply water temperatures by representative building loads or by outdoor air temperature		

		5.2.5	Additional controls for SuperECBC Building	Indicate that the mechanical systems comply with § 5.2.4 and § 5.2.5	
		5.2.5.1	Variable Air Volume Fan Control	Indicate Fans in VAV systems shall have controls or devices to limit fan motor demand as per § 5.2.5.1	
		5.2.6	Piping & ductwork	Indicate sealing, caulking, gasketing, and weatherstripping	
		5.2.6.1	Piping insulation	Indicate R-value of insulation	
		5.2.6.2	Ductwork and Plenum insulation	Indicate R-value of insulation	
		5.2.7	System Balancing	Show written balance report for HVAC systems serving zones with a total conditioned area exceeding 500 m2	
		5.2.8	Condensers	Indicate location of condenser and source of water used for condenser	
		5.2.9	Service Hot Water Heating		
		5.2.9.1	Solar Water Heating	Indicate all Hotels and hospitals have solar water heating equipment installed for hot water design capacity as per § 5.2.9.1	
		5.2.9.2	Heating Equipment Efficiency	Indicate service water heating equipment shall meet the performance and efficiency as per § 5.2.9.2	
		5.2.9.3	Supplementary Water Heating System	Indicate supplementary heating system is designed in consideration with § 5.2.9.3	
		5.2.9.4	Piping Insulation	Indicate the Piping insulation is compliant with § 5.2.6.1.	
		5.2.9.5	Heat Traps	Indicate vertical pipe risers serving water heaters and storage tanks are as per § 5.2.9.5	
		5.2.9.6	Swimming Pools	Indicate the heated pools are provided with a vapor retardant pool cover on the water surface and temperature control and minimum insulation value as per § 5.2.9.6	

Prescriptive Compliance Option (Section 5.3)

		5.3.1	Fans	Indicate fan type, motor efficiency and mechanical efficiency	
		5.3.2	Pumps	Indicate pump type (Primary, secondary, and condenser), its total installed capacity and efficiency	
		5.3.3	Cooling Towers	Indicate cooling tower type and installed capacity	
		5.3.4	Air-Economizer (ECBC/ECBC+/SuperECBC)	Indicate air economizer is capable of modulating outside-air and return-air dampers to supply 50% of design supply air quantity as outside-air for respective building type.	
		5.3.4	Water-economizer (ECBC/ECBC+/SuperECBC)	Indicate water economizer is capable of providing 50% of the expected system cooling load at outside air temperatures of 10°C dry-bulb/7.2°C wet-bulb and below, if the designed building is a respective building type.	
		5.3.4.3	Partial Cooling	Indicate where required by § 5.3.4 economizers shall be capable of providing partial cooling even when additional mechanical cooling is required to meet the cooling load.	
		5.3.4.4	Controls	Indicate air economizers are equipped with controls as specified in § 5.3.4.4	
		5.3.9	Testing	Indicate air-side economizers have been tested as per the requirement specified	
		5.3.5	Variable Flow Hydronic Systems		

		5.3.5.1	Variable Fluid Flow	Indicate design flow rate of HVAC pumping system		
		5.3.5.2	Isolation Valves	Indicate water cooled air-conditioning have two-way automatic isolation valves and pump motors greater than or equal to 3.7 kW is controlled by variable speed drives		
		5.3.5.3	Variable Speed Drives	Indicate Chilled water or condenser water systems comply with either § 5.3.5.1 or § 5.3.5.2		
		5.3.5.4	Heat Recovery	Indicate for all Hospitality and Healthcare, heat recovery effectiveness, and efficiency of oil and gas fired boilers		
		5.4	System Efficiency-Alternate Compliance approach	Attach simulation report		
		5.5	Low Energy Comfort Systems	Indicate system type and list the exemption claimed		

DRAFT

Lighting and Controls Summary

Energy Conservation Building Code 2017 Compliance Forms

Project Info	Project Address:	Date
		For Building Department Use
	Project Built-up Area (m ²):	
	Project Above-grade area (m ²):	
	Project Conditioned Area (m ²):	
	Applicant Name and Address:	
Project Climatic Zone:		

Compliance Option	<input type="checkbox"/> Space by Space method	<input type="checkbox"/> Whole Building Method
-------------------	--	--

Maximum Allowed Lighting Power (Interior, Section 6.3.2 or 6.3.3)

Location (floor/room no.)	Occupancy Description	Allowed Watts per m ² **	Area in m ²	Allowed x Area
** Document all exceptions			Total Allowed Watts	

Proposed Lighting Power (Interior)

Location (floor/room no.)	Fixture Description	Number of Fixtures	Watts/ Fixture	Watts Proposed
Total Proposed Watts may not exceed Total Allowed Watts for Interior			Total Proposed Watts	

Maximum Allowed Lighting Wattage (Exterior, Section 6.3.5)

Location	Description	Allowed Watts per m ² or per lm	Area in m ² (or lm for perimeter)	Allowed Watts x m ² (or x lm)
Total Allowed Watts				

Proposed Lighting Wattage (Exterior)

Location	Fixture Description	Number of Fixtures	Watts/ Fixture	Watts Proposed
Total Proposed Watts may not exceed Total Allowed Watts for Exterior			Total Proposed Watts	

Lighting & Controls Checklist

Energy Conservation Building Code 2017 Compliance Forms

Project Address						Date	
The following information is necessary to check a building permit application for compliance with the lighting requirements in the Energy Conservation Building Code 2017.							
Applicability			Code Section	Component	Information Required		
Yes	No	N/A				Location on Plans	Building Department Notes
Lighting and Controls							
Mandatory Provisions (Section 6.2)							
			6.2.1	Lighting Controls			
			6.2.1.1	Automatic shutoff	Indicate automatic shutoff locations or occupancy sensors		
			6.2.1.2	Space control	Provide schedule with type, indicate locations		
			6.2.1.3	Daylit Zones	Provide manual or automatic control device schedule with type and features, indicate locations		
			6.2.1.4	Centralized Controls_ECBC+ and SuperECBC Buildings	Provide centralized control system schedule with type and features, indicate locations		
			6.2.1.5	Ext. lighting control	Indicate photosensor or astronomical time switch		
			6.2.1.6	Additional control	Provide schedule with type, indicate locations		
			6.2.3	Exit signs	Indicate wattage per face of Exit signs		
Prescriptive Interior Lighting Power Compliance Option (Section 6.3)							
			6.3	LPD compliance	Indicate whether project is complying with the Building Area Method (6.3.2) or the Space Function Method (6.3.3)		
			6.3.2	Building area method	Provide lighting schedule with wattage of lamp and ballast and number of fixtures. Document all exceptions.		
			6.3.2	Space function method	Provide lighting schedule with wattage of lamp and ballast and number of fixtures. Document all exceptions.		
			6.3.3	Luminaire wattage	Indicate the wattage of installed luminaires on the floor plan. In case of luminaires containing permanently installed ballasts, the operating input wattage has to be provided, either from manufacturers catalogs or values from independent testing laboratory reports.		
Prescriptive Exterior Lighting Power Compliance Option (Section 6.3.5)							
			6.4	External light allowance	Provide lighting schedule with wattage of lamp and ballast and number of fixtures. Document all exceptions.		

Lighting & Controls Checklist

Energy Conservation Building Code 2017 Compliance Forms

Project Address					Date		
The following information is necessary to check a building permit application for compliance with the lighting requirements in the Energy Conservation Building Code 2017.							
Applicability			Code Section	Component	Information Required	Location on Plans	Building Department Notes
Yes	No	N/A					
Lighting and Controls							
Mandatory Provisions (Section 6.2)							
			6.2.1	Lighting Controls			
			6.2.1.1	Automatic shutoff	Indicate automatic shutoff locations or occupancy sensors		
			6.2.1.2	Space control	Provide schedule with type, indicate locations		
			6.2.1.3	Daylit Zones	Provide manual or automatic control device schedule with type and features, indicate locations		
			6.2.1.4	Centralized Controls_ECBC+ and SuperECBC Buildings	Provide centralized control system schedule with type and features, indicate locations		
			6.2.1.5	Ext. lighting control	Indicate photosensor or astronomical time switch		
			6.2.1.6	Additional control	Provide schedule with type, indicate locations		
			6.2.3	Exit signs	Indicate wattage per face of Exit signs		
Prescriptive Interior Lighting Power Compliance Option (Section 6.3)							
			6.3	LPD compliance	Indicate whether project is complying with the Building Area Method (6.3.2) or the Space Function Method (6.3.3)		
			6.3.2	Building area method	Provide lighting schedule with wattage of lamp and ballast and number of fixtures. Document all exceptions.		
			6.3.2	Space function method	Provide lighting schedule with wattage of lamp and ballast and number of fixtures. Document all exceptions.		
			6.3.3	Luminaire wattage	Indicate the wattage of installed luminaires on the floor plan. In case of luminaires containing permanently installed ballasts, the operating input wattage has to be provided, either from manufacturers catalogues or values from independent testing laboratory reports.		
Prescriptive Exterior Lighting Power Compliance Option (Section 6.3.5)							
			6.4	External light allowance	Provide lighting schedule with wattage of lamp and ballast and number of fixtures. Document all exceptions.		

14. APPENDIX E: BEE APPROVED LIST OF SOFTWARE TO SHOW COMPLIANCE⁵

Table 14-1 Bureau of Energy Efficiency Approved Software for Demonstrating Compliance with ECBC

<i>Analysis</i>	<i>Software</i>
<i>Whole Building Performance Method</i>	<i>AECOSim</i>
	<i>Design Builder</i>
	<i>DOE2</i>
	<i>EnergyPlus</i>
	<i>eQUEST</i>
	<i>HAP</i>
	<i>IDA-ICE</i>
	<i>IES-VE</i>
	<i>OpenStudio</i>
	<i>Simergy</i>
	<i>Trace700</i>
	<i>TRNSYS</i>
	<i>Visual DOE</i>
	<i>Daylighting</i>
<i>Daysim</i>	
<i>Design Builder</i>	
<i>DIVA</i>	
<i>Groundhog</i>	
<i>IES-VE</i>	
<i>OpenStudio</i>	
<i>Radiance-Rhino-Grasshopper with Daylighting Plugins</i>	
<i>Sefaira</i>	
<i>Sensor Placement + Optimization Tool (SPOT)</i>	

⁵ This is not an all-inclusive list. The current list of approved software is available at BEE website (<https://www.beeindia.gov.in/>).

15. REFERENCES

- Grondzik, Walter T., Alison G. Kwok, Benjamin Stein, and John S. Reynolds. 2010. *Mechanical and Electrical Equipment for Buildings*. 11 edition. Wiley.
- 90.1 User's Manual: ANSI/ASHRAE/IESNA Standard 90.1-2007. 2008. American Society of Heating, Refrigerating & Air-Conditioning Engineers, Incorporated
- "Building Science Corporation | Consulting & Architecture.". <https://buildingscience.com/>.

DRAFT



Bureau of Energy Efficiency

4th Floor, Sewa Bhawan, R. K.Puram, New Delhi - 110066

www.beeindia.gov.in